

WORLD LEADER IN CONTROL & MEASUREMENT

PRODUCT GUIDE



HANYOUNG nux

Global leader in control & measurement



nux
HANYOUNG



Control switches



Temperature controllers



Proximity sensors /
Photo sensors



Power supplies



Turn lights /
Sign towers

CONTENTS

Instrument

22
page

Temperature
Controllers



55
page

Recorders



57
page

Digital Counter /
Timers

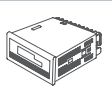

66
page

Analog Timers



71
page

Multi Pulse
Meters

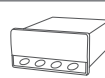

85
page

Electrode Level Switch,
Data Storage Device
Communication Converter,
Temperature and Humidity Converter

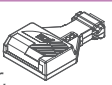

Sensor

87
page

Proximity Sensors

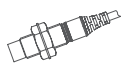

99
page

Photo Sensors



114
page

Rotary Encoders



Electric Power Device

118
page

Thyristor Power
Regulators



126
page

Solid State Relays



140
page

Power supplies

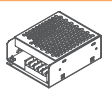

Control switch

143
page

Control Switches /
Combination Display Lights



151
page

Power / Main /
Cam switches



154
page

Limit Switches



156
page

Micro Switches



157
page

Foot/Mono Lever/
Pendant Switches



Sign Towers & Lights

161
page

Sign Towers



166
page

Wall Mounted Lights



167
page

Turn Lights



168
page

Warning Lights



Etc

170
page





Terminal Blocks, Power Buzzers,
Fuse Holders, Control Boxes





Selection Table



Temperature Controllers



| Type | LCD Temperature Controllers | |
|---------------|---|--|
| Model | VX series | |
| Appearance |  | |
| Features | <ul style="list-style-type: none"> Wide viewing angle LCD and white backlight Several input sensor support (TC, RTD, Voltage, Current) High precision (0.2 % accuracy) | <ul style="list-style-type: none"> High speed sampling cycle (50 ms) IP65 (IEC 60529) front degree of protection Convenient parament setting by USB cable |
| Power voltage | 100-240 V a.c. 50/60 Hz, 24 V d.c. | |
| Accuracy | ±0.2 % of FS ± 1 digit | |
| Input | RTD, thermocouple, DC voltage, DC current | |
| Output | Relay output, SSR output, current output | |
| Control type | ON/OFF, PID control, 2DOF PID control | |
| Page | 22 | |



| Type | Multi Input / Output Temperature Controllers | Easy Operation Temperature Controllers | Multi Input Temperature Controllers | |
|---------------|---|---|--|--|
| Model | NX series | DX series | AX series | KX series |
| Appearance |  |  |  |  |
| Features | <ul style="list-style-type: none"> Fuzzy function, PID auto-tuning 3 zone PID/ Group PID 3 types Ramp control function Heating / cooling control, Heater break alarm 3 set value type selection function by digital input (DI) Communication function (RS485/422) | <ul style="list-style-type: none"> PID auto-tuning Direct/reverse operation internal selection High and Low alarm output Control loop break alarm (LBA) Decimal point display and high / low setting limitation Retransmission output | <ul style="list-style-type: none"> Multi Input High speed sampling cycle (0.1 sec) Installation depth: 63 mm Control output selectable : reverse operation/ direct operation Control loop break alarm (LBA) | <ul style="list-style-type: none"> Multi Input Decimal point position selection 2-stage step function by external contact (KX4S) Output operation selectable : reverse operation/direct operation PID auto-tuning |
| Power voltage | 100-240 V a.c. 50/60 Hz, 24 V d.c. | | 100-240 V a.c. 50/60 Hz | 100-240 V a.c. 50/60 Hz, 24 V d.c.(Exclude KX4S) |
| Accuracy | 0.5 % of FS | | ±0.3 % of FS | 0.5 % of FS |
| Input | RTD, thermocouple, DC voltage | | | |
| Output | Relay output, SSR output, current output | | | |
| Control type | PID control/ ON-OFF control | | | |
| Page | 26 | 28 | 25 | 30 |

| Type | Multi-Channel Digital Temperature Controllers | Modular Multi-Channel Temperature Controllers | Multi Input Temperature Controllers |
|---------------|--|---|--|
| Model | MC9 | ML series | MT100 |
| Appearance |  |  |  |
| Features | <ul style="list-style-type: none"> 4/8 channel control function Multi-memory function (ax 8 X 8) Heating / cooling control (4 channels) Digital input(DI) Communication function (RS232, RS485/422) | <ul style="list-style-type: none"> Sampling cycle 50 ms 8 Event output contact units Max. 32 parallel connections (including ML-E) Unit power, communication connection by side connector Communication function (RS232C, RS485) | <ul style="list-style-type: none"> Input 4 channels (control: 2 channels, monitoring: 2 channels) Temperature, pressure, current detection alarm functions Abnormal history display and saving functions Medium replenishment and suction function Communication function (RS485/422) |
| Power voltage | 100-240 V a.c. 50/60 Hz | | 100-240 V a.c. 50/60 Hz |
| Accuracy | ±0.3 % of FS ±1 Digit | | Temperature : ±0.3 % of FS ± 1 Digit Pressure : ±3 % of FS ±1 Digit |
| Input | RTD, thermocouple, DC voltage | | RTD, thermocouple |
| Output | Relay output, SSR output, current output, Triac output | Relay output, SSR output, current output | |
| Control type | PID control / ON-OFF control | | PID control |
| Page | 42 | 41 | 44 |



■ Temperature Controllers



| Type | Modular Programmable Temperature Controllers | | 2-Channel Programmable Temperature Controllers | |
|---------------|--|--|---|--|
| Model | TD510 | | TD500 | TD300 |
| Appearance |  | |  |  |
| Features | <ul style="list-style-type: none"> · Several alarm functions · Multi input (RTD, TC, VDC) · Communication function built-in (RS485) · Detachable and expandable structure · Digital Recorder function (internal memory, SD card storage) · Digital input (DI) max. 32 contacts, digital output (DO) max. 32 contacts | | <ul style="list-style-type: none"> · Max. 100 patterns, 100 segments / pattern (total 2,400 segments) · Several alarm functions (output: 4 contacts, operation: 20 types) · Digital input (DI) 8 contacts, Digital output (DO) 16 contacts · Communication function | <ul style="list-style-type: none"> · Max. 100 patterns, 100 segments/pattern (total 2,400 segments) · Several alarm functions (output: 4 contacts, operation: 20 types) · Digital input (DI) 8 contacts, Digital output (DO) 8 contacts · Communication function |
| Power voltage | 100-240 V a.c. 50/60 Hz | | | |
| Accuracy | ±0.15 % of FS | | ±0.1 % of FS | |
| Input | RTD, thermocouple, DC voltage | | | |
| Output | Relay output, SSR output, current output | | | |
| Control type | PID control/ ON-OFF control | | | |
| Page | 32 | | 33 | 34 |

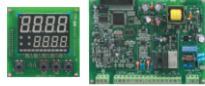

| Type | Modular Programmable Temperature & Humidity Controllers | | Programmable Temperature & Humidity Controllers | |
|---------------|--|--|--|---|
| Model | TH510 | | TH500 | TH300 |
| Appearance |  | |  |  |
| Features | <ul style="list-style-type: none"> · Communication function built-in (RS485) · Detachable and expandable structure · Temperature, humidity independent PID control · Digital recorder function (internal memory, SD card storage) · Digital input (DI) max. 32 contacts, digital output (DO) max. 32 contacts | | <ul style="list-style-type: none"> · 100 patterns (total 6000 segments) · Temperature, humidity independent PID control · Digital input (DI) 8 contacts, Digital output (DO) 20 contacts · Communication function built-in | <ul style="list-style-type: none"> · 100 patterns (total 2000 segments, 100 segments / pattern) · Temperature, humidity independent PID control · Digital input (DI) 4 contacts, digital output (DO) 12 contacts · Communication function |
| Power voltage | 100-240 V a.c. 50/60Hz | | | |
| Accuracy | Temperature: ±0.1 % of FS / Humidity: ±1 % of FS | | | Temperature: ±0.2 % of FS / Humidity: ±2 % of FS |
| Input | RTD, DC voltage | | | |
| Output | SSR output, current output | | | |
| Control type | PID control/ ON-OFF control | | | |
| Page | 36 | | 35 | 37 |

| Type | Thermal Shock Test Controllers | | Thermal Impact Test Controller | Programmable Temperature Controllers |
|---------------|---|--|---|---|
| Model | TS510 | | TS500 | NP200 |
| Appearance |  | |  |  |
| Features | <ul style="list-style-type: none"> · Damper & elevator method support · Multi input (RTD, TC, VDC) · Communication function built-in (RS485) · Detachable and expandable structure · Digital Recorder function (internal memory, SD card storage) · Digital input (DI) max. 32 contacts, digital output (DO) max. 32 contacts | | <ul style="list-style-type: none"> · Support for chambers in a variety of ways (Elevator, Demper, Gas) · Multi input (RTD, TC, VDC) · Digital input (DI) max. 16 contacts, digital output (DO) max. 24 contacts · Remote Control and Monitoring via Communication (RS232/RS485) · Record test information (when using external storage device EM310) | <ul style="list-style-type: none"> · Multi input / output, ± 0.1 % high accuracy · 30 patterns, 300 segment (1 pattern / 99 segments) · Heating / cooling PID control · 3-level PID selection (4 PID groups) · PID auto-tuning mode 2 types · Digital input (DI) 7 contacts, User output (UO) 10 contacts · Communication function |
| Power voltage | 100-240 V a.c. 50/60Hz | | | |
| Accuracy | RTD : ±0.1% of FS, thermocouple : ±0.15 % of FS | | ±0.1 % of FS | |
| Input | RTD, thermocouple, DC voltage | | | |
| Output | SSR output, current output | | Relay output, SSR output, current output | |
| Control type | PID control/ ON-OFF control | | | |
| Page | 39 | | 40 | 38 |



Selection Table

| Type | Board Type Temperature Controllers | | Cost-Effective Digital Temperature Controllers |
|---------------|---|---|--|
| Model | BX8 | SM100 | ED6 |
| Appearance |  |  |  |
| Features | <ul style="list-style-type: none"> Fuzzy function, PID auto-tuning 3 zone PID/ Group PID 3 types Ramp control function Heating / cooling control, Heater break alarm 3 set value type selection function by digital input (DI) Communication function (RS485) | <ul style="list-style-type: none"> 20 Channel integrated digital temperature controller ± 0.5% display accuracy of max. range Several alarm functions. (digital output 3 contacts) Communication function built-in (RS485/422,RS232C) | <ul style="list-style-type: none"> Heating/cooling control selection Alarm output and timer output selection ON/OFF, Proportional control selection 0.1 °C / 1 °C selection Delay output time setting |
| Power voltage | 100-240 V a.c. 50/60 Hz | | 100-240 V a.c. 50/60 Hz, 10-24 V a.c. 50/60 Hz or 10-24 V d.c. |
| Accuracy | ±0.5% of FS ±1 Digit | | ±0.5 % of FS ±1 Digit |
| Input | RTD, thermocouple, DC voltage | | RTD, thermocouple |
| Output | Relay output, SSR output, current output | | Relay output, SSR output |
| Control type | PID control/ ON-OFF control | | Proportional control, ON/OFF control |
| Page | 45 | 46 | 51 |

| Type | Easy Operation Temperature Controllers | | Temperature Controllers Without Indicator |
|---------------|---|---|---|
| Model | HY-8000S / 8200S / 72D / 48D | DF series | HY-2000, HY-1000, ND4 |
| Appearance |  |  |  |
| Features | <ul style="list-style-type: none"> Proportional control or ON / OFF control Convenient temperature setting Alarm setting (HY-8200S) Sharp digital display | <ul style="list-style-type: none"> Proportional control or ON / OFF control Convenient temperature setting Auxiliary output setting (SUB) Sharp digital display Convenient 8 pin socket type (DF4) | <ul style="list-style-type: none"> Proportional control or ON/OFF control Convenient temperature setting Plug-in method Burnout function Strong against vibrations and impacts, so it can be installed directly on the machine |
| Power voltage | 110/220 V a.c. 50/60Hz (Common) | DF2 : 110/220 V a.c. 50/60 Hz(Common) DF4 : 110 V a.c. 50/60 Hz, 220 V a.c. 50/60 Hz ※ The DF4 power voltages are divided into 110 V and 220 V specifications. | HY-1000 : 110/220 V a.c. 60 Hz (Common) HY-2000 : 110/220 V a.c. 60 Hz (Common) ND4 : 110 V a.c. 60 Hz, 220 V a.c. 60 Hz ※ The ND4 power voltages are divided into 110 V and 220 V specifications. |
| Accuracy | ±1 % of FS ±1 Digit | | Non-indicating |
| Input | RTD, thermocouple, DC voltage | | RTD, thermocouple |
| Output | Relay output, SSR output, current output | | Relay output |
| Control type | Proportional control | | |
| Page | 47 | 48 | 49 |

| Type | Temperature Controllers For Refrigerators | | Temperature Controllers For Greenhouses |
|---------------|---|--|---|
| Model | BR6A | BR6 | HD6 |
| Appearance |  |  |  |
| Features | <ul style="list-style-type: none"> Heating/cooling control selection Alarm output, timer output selection ON/OFF, Proportional control selection 0.1°C / 1°C selection Delay output time setting Operation convenience improved with the set move key | <ul style="list-style-type: none"> Heating/cooling control selection Alarm output and timer output selection ON/OFF, Proportional control selection 0.1 °C / 1 °C selection Delay output time setting | <ul style="list-style-type: none"> Greenhouse open / close motor control only 1-, 2-stage control operation according to set value Hysteresis setting by ON/OFF output Operation according to temperature and time setting 0.1 °C display function |
| Power voltage | 100-240 V a.c. 50/60 Hz or 100-240 V d.c. | 100-240 V a.c. 50/60 Hz 10-24 V a.c. 50/60 Hz or 10-24 V d.c. | 100-240 V a.c. 50/60 Hz |
| Accuracy | ±1 % of FS ±1 Digit | | ±1 % of FS |
| Input | Hanyoung Nux exclusive sensor(TH-570N) | | Hanyoung Nux exclusive sensor(TH-540N) |
| Output | Relay output, SSR output | | Relay output |
| Control type | Proportional control, ON/OFF control | | |
| Page | 50 | 50 | 51 |



■ Temperature Indicators

| Type | Digital Temperature Indicators | Large LED Temperature Indicators | Multi Input Temperature Indicators |
|---------------|---|--|--|
| Model | BK3 | HN100 | BK6-M |
| Appearance |  |  |  |
| Features | <ul style="list-style-type: none"> · 0.5 % high accuracy indicator · Simple exclusive indication · Character height 14.2/20.0 mm LED applied | <ul style="list-style-type: none"> · Large LED indication · IP57 (IEC 60529) waterproof type · Stainless external case · Suitable for saunas, green houses, sport centers, Greenhouses | <ul style="list-style-type: none"> · Multi Input (thermocouple, RTD, voltage · current) · Retransmission output (4 - 20 mA d.c.) · Temperature unit selection · Measured value correction function |
| Power voltage | 110/220 V a.c. 50/60Hz(Common) | 12 V d.c. (Power Line Length: 1.8 m Standard) | 100-240 V a.c. 50/60 Hz |
| Accuracy | ±0.5 % of FS | ±0.5 % of FS ±1 Digit | |
| Input | RTD, thermocouple, DC voltage, DC current | RTD, DC current | Multi Input (19 types), thermocouple, RTD |
| Page | 52 | 54 | 53 |





■ Data Storage Devices

■ Floatless Level Switches

■ Electrode Holder



| Type | Data Storage Devices | Floatless Level Switches | Electrode Holder |
|---------------|---|--|--|
| Model | EM310 | FS - 3A | HY-ER3 |
| Appearance |  |  |  |
| Features | <ul style="list-style-type: none"> · 32 Mbyte data storage device · Convenient panel installation type (72 × 36 mm) · USB port for memory stick connection | <ul style="list-style-type: none"> · Used for agricultural water, water treatment plant, sewage treatment plant, factory and several surface water control · Lightweight and easy to install · Operation status is indicated by LED | <ul style="list-style-type: none"> · IP63 (IEC 60529) degree of protection · The PBT flame retardant provides robustness and reduces the fire risk · Body and cover are connected by hook coupling structure so they are easily detached by screwdriver |
| Power voltage | 24 V d.c. 500 mA | 110 V a.c. 50/60 Hz, 220 V a.c. 50/60 Hz | - |
| Page | 85 | 86 | 86 |

■ Converters



| Type | Ethernet To Serial Converters | Communication Converters | | Temperature / Humidity Converters |
|---------------|--|---|--|---|
| Model | HMCE-103 | CV310 | CV300 | CV250 |
| Appearance |  |  |  |  |
| Features | <ul style="list-style-type: none"> · Several connection interface support (RS232 / RS485 / RS422) · Open network protocol support · Up to 3 clients can be simultaneously connected | <ul style="list-style-type: none"> · RS232 and RS485 / RS422 · 2 kV electrical insulation built-in protection device · RS485 Echo, Non-Echo function support · Excellent compatibility with fast transmission/reception switching speed · Max. 1.2 Km, 256 Node connection available | <ul style="list-style-type: none"> · RS422/485 Line Drive Automatic Control · Switch settings enable/disable various modes of operation · Up to 1.5 km, 256 node connectivity · LED for Power and Data Communication Status Indication | <ul style="list-style-type: none"> · DIN rail and bolt fixing mounting method · Uniform with DC signal · Relative humidity calculation by dry bulb temperature and wet bulb temperature · Two-wire transmission line is simple · Linear signal |
| Power voltage | 5 V d.c. (±10 %) | 9-30 V d.c. | 9 V, 300mA d.c. Adapter (1.3 Ø d.c. Jack) | 100-240V a.c. 50/60 Hz |
| Page | 85 | | | |



Selection Table

Recorders

| Type | Touch Screen Recorders | | 2-channel temperature controllers & recorders | |
|-----------------|--|--|---|--|
| Model | GR200 | | RT9N | |
| Appearance |  | |  | |
| Features | <ul style="list-style-type: none"> High-definition screen : 5.7" 640×480 TFT-LCD Large memory: SD and SDHC card support (internal memory: 80 MB) 3-language support: Korean, English, Chinese (simplified) Data storage and parameter backup function with SD card RS485/422/ETHERNET | | <ul style="list-style-type: none"> Multi input/output Communication function(RS485) Free scale function PID auto-tuning Temperature record & control | |
| Power voltage | 100-240 V a.c. 50/60 Hz | | | |
| Accuracy | ±0.15 % of FS ±1 Digit | | ±0.5 % of FS | |
| Input | RTD, thermocouple, DC voltage | | | |
| Channels | 2/4/8/12 channels | | 1/2 channels | |
| Contact outputs | 6contacts, 12contacts | | Alarm: 2 contacts, Control output: 1 contact | |
| Page | 55 | | 56 | |







Counter / Timers



| Type | LCD Counter / Timers | | | |
|-------------------|--|--|---|--|
| Model | LC series | | | |
| Appearance |  | | |  |
| Features | <ul style="list-style-type: none"> Improved visibility with the wide viewing angle LCD and white display Using the tack switch and applying ABS material (enhanced durability) IP66 Protection Structure (Front of Product) | | <ul style="list-style-type: none"> Pre-scale setting range expanded (0.00001 ~ 999999) Support for RS485 Communication (Modbus RTU) | |
| Power voltage | 100-240 V a.c. 50/60 Hz, 24-48 V a.c. 50/60 Hz or 24-48 V d.c. (Voltage fluctuation rate: ±10 %) | | | |
| Type | Preset method | | | |
| Control functions | Counter, Timer | | | |
| Display digits | 4 digits, 6 digits | | | |
| Setting stages | 1-stage setting, 2-stage setting | | | |
| Page | 57 | | | |

| Type | Digital Counter / Timers | | Digital Counter | |
|-------------------|---|--|--|--|
| Model | GF series | | LC1 | |
| Appearance |  | |  | |
| Features | <ul style="list-style-type: none"> Counter & timer functions Pre-scale setting (GF7) 14 input operations, 16 output operations Decimal places setting 16 timer ranges (decimal / sexagesimal 8 types) NPN/PNP (voltage / non-voltage) input selection | | <ul style="list-style-type: none"> Compact LCD indicating total counter External power not needed with the built-in battery You can reuse the product by replacing the battery Small Power consumption and long battery life Non-voltage or voltage input IP66 (IEC 60529) degree of protection (front side) | |
| Power voltage | 100-240 V a.c. 50/60 Hz | | Lithium battery built-in | |
| Type | Preset method, Indication only | | Indication only | |
| Control functions | Counter, Timer | | Counter | |
| Display digits | 4 digits, 6 digits | | 8digits (addition) | |
| Setting stages | 1-stage setting, 2-stage setting | | - | |
| Page | 59 | | 58 | |

■ Timers





| | | |
|----------------|---|--|
| Type | LCD Timers | |
| Model | LT4 / LT4S | |
| Appearance |    | |
| Features | <ul style="list-style-type: none"> Bright and easy to view with the wide viewing angle LCD IP66 Protection Structure (Front of Product) Time limit 1c, Instantaneous 1c + Time limit 1c, Time limit 2c, STAR + DELTA Minimum signal time selection (1 ms / 20 ms) | <ul style="list-style-type: none"> Several time ranges (0.01 sec ~ 9999 hrs) Several operation modes (LT4: 7 operation modes, LT4S: 10 operation modes) One-shot output time setting (0.01 sec ~ 99.99 sec) |
| Power voltage | 24-240 V a.c. 50/60 Hz or 24-240 V d.c. | |
| Display digits | 4 digits | |
| Time specs | 0.01 sec ~ 9999 hour | |
| Page | 60 | |

| | | | |
|----------------|---|---|--|
| Type | LCD Timers | | LCD Weekly & Yearly Time Switches |
| Model | LT1 | LF4N | LY series |
| Appearance |   |   |   |
| Features | <ul style="list-style-type: none"> External power not needed with the built-in battery You can reuse the product by replacing the battery Long battery life with small power consumption Non-voltage or voltage input IP66 Protection Structure (Front of Product) | <ul style="list-style-type: none"> LCD display (displays several functions) Multi input ranges (10 types) Multi output operations (10 types) Bar graph over time display Reset, start and inhibit inputs | <ul style="list-style-type: none"> Easy to check and change programs Automatic change of seasonal program according to season setting function It is possible to add the yearly program to the weekly program The holiday setting function can block the output during the selected holidays |
| Power voltage | Lithium battery built-in | 24-240 V a.c. 50/60 Hz or 24-240 V d.c. | 100-240 V a.c. 50/60 Hz |
| Display digits | 8 digits (addition) | 3 digits | 4 digits, 2 lines |
| Type | Indication only | - | - |
| Time specs | - | 0.01 s ~ 9990 h | Minimum spacing interval: 1 minute |
| Page | 61 | 64 | 65 |



| | | | |
|----------------|--|--|---|
| Type | Digital Twin Timers | | Digital Timers |
| Model | TT7H | TT4 | TF4 |
| Appearance |  |  |  |
| Features | <ul style="list-style-type: none"> Output operation control according to external START input signal Individual setting of ON time and OFF time Wide power specifications (100 - 240 V a.c. 50/60 Hz) | <ul style="list-style-type: none"> Free voltage (100 - 240 V a.c. 50/60 Hz) Dual timer & twin timer functions (Can be used as 2 independent timers) Output operation control according to external input signal (START, RESET, INHIBIT) | <ul style="list-style-type: none"> Simple functions, convenient setting Range selection with front side deep switch (2 types) Decimal or sexagesimal Relay or transistor output |
| Power voltage | 220 V a.c. 60Hz | 100-240 V a.c. 50/60Hz | 100-240 V a.c. 50/60 Hz, 24-60 V d.c. |
| Display digits | 4 digits | | 3 digits, 4 digits |
| Time specs | 0.01 s ~ 9999 hour | | Refer to standard range |
| Page | 62 | | 63 |



Selection Table

Analog Timer



| Type | Timing Relays | ON-Delay Timer | Twin / Dual Timers | Multi Timers | Star-Delta Timers |
|---------------|---|---|---|--|---|
| Model | T21 | T38N, T48N, T57N | TF62N, TF62D | MA4N | MA4SD |
| Appearance |  |  |  |  |  |
| Features | <ul style="list-style-type: none"> Timing Relay (time limit 4c) Plug-in type (14 pins) Time range and operation mode customizable by the user Several time ranges Multi operation mode | <ul style="list-style-type: none"> Time progress display using ON LED Several time ranges (7 types) Time unit selectable (hours, minutes, seconds) Several model configurations (5 types) | <ul style="list-style-type: none"> Time progress display using ON LED Several time ranges (7 types) Time unit selectable (hours, minutes, seconds) Several model configurations (5 types) | <ul style="list-style-type: none"> Output operation modes (6 types) Multi range (4 types) Time units (4 types) Reset, start and inhibit inputs | <ul style="list-style-type: none"> 8-pin plug type High capacity motor start timer Star-delta contact outputs, instantaneous contact outputs Wide power specifications (AC/DC dual usage) |
| Power voltage | 100-120 V a.c. 50/60 Hz, 200-230 V a.c. 50/60 Hz, 24 V d.c. | 24-240 V a.c. 50/60 Hz or 24-240 V d.c., 12 V d.c.(T48N Only, Order Specification) | 24-240 V a.c. 50/60 Hz or 24-240 V d.c. | | 100-240 V a.c. 50/60 Hz, 24-240 V d.c. |
| Time specs | 0.1 s ~ 24 hour | 0.01 s ~ 60 hour | Time range selection (3 types) | Minimum spacing interval : 1 minute | 1~300 s |
| Page | 66 | 67 | 68 | 69 | 70 |







Multi Pulse Meters





| Type | LCD Multi Pulse Meters | |
|-----------------|--|--|
| Model | LP3 | |
| Appearance |  |  |
| Features | <ul style="list-style-type: none"> Improved visibility with the wide viewing angle LCD and white display 66.4 mm Short Back Length IP66 Protection Structure (Front of Product) | <ul style="list-style-type: none"> Expand Maximum Display Range : -99999 ~ 99999 Various functions : AUTO ZERO, Start compensation timer, comparative output limit, hysteresis, Set display period, select time unit, display maximum and minimum values, electrostatic memory, etc. |
| Power voltage | 100-240 V a.c. 50/60 Hz | |
| Operation modes | Number of revolutions, frequency, speed, Moving speed, cycle, transit time, time difference, time width, measured length, interval, integration, absolute ratio, error ratio, density, error | |
| Input frequency | Contactless (max. 50 KHz, ON/OFF pulse width 10 us min), contact (max. 30 Hz, ON/OFF pulse width min. 16.6 ms) | |
| Display cycle | 0.05, 0.5, 1, 2, 4, 8 sec | |
| Output | Proportional control, ON/OFF control | |
| Page | 71 | |

| Type | Small LCD Pulse Meters | Multi Pulse Meters | Multi Pulse Meters |
|-----------------|---|---|---|
| Model | LP1 | BP6 | RP series |
| Appearance |  |  |  |
| Features | <ul style="list-style-type: none"> Small LCD Pulse Meters Rotation speed / Frequency measurement 5-digit display available External power not needed with the built-in battery Non-voltage or free voltage input | <ul style="list-style-type: none"> Auto zero time setting Comparative output (HH, H, GO, L, LL) Start compensation timer function Max. value (5 types), min value (5 types) save Power outage compensation function Max. 50 KHz | <ul style="list-style-type: none"> Auto zero time setting Comparative output (HH, H, GO, L, LL) Start compensation timer function Max. value (5 types), min value (5 types) save Power outage compensation function Max. 10 KHz input |
| Power voltage | Lithium battery built-in | 100-240 V a.c. 50/60 Hz, 24-60 V a.c. 50/60 Hz or 24-60 V d.c. | |
| Operation modes | Revolution speed, frequency | Number of revolutions, frequency, speed, Moving speed, cycle, transit time, time difference, time width, pulse width, pulse interval, integration counter, absolute ratio, error ratio, density, error | Number of revolutions, frequency, speed, Moving speed, cycle, transit time, time difference, time width, pulse width, pulse interval, integration counter |
| Input frequency | - | 50 KHz | 10 KHz |
| Display cycle | - | 0.05, 0.5, 1, 2, 4, 8 sec | |
| Output | - | Relay, transistor | Relay, transistor, retransmission |
| Page | 72 | 74 | 73 |

Selection Table





| Type | LCD Multi Panel Meters | |
|----------------|--|--|
| Model | LM | |
| Appearance |    | |
| Features | <ul style="list-style-type: none"> · Use optical night angle LCD and white backlight · Short rear length of 68 mm (LM3) and 81 mm (LM6) · IP66 Protection Structure (Front of Product) · RMS and AVG Selection Instrumentation · MODBUS Communication Support · Maximum measurement input specification (500 V d.c., 500 V a.c., 5A d.c., 5A a.c.) | |
| Power voltage | 100-240 V a.c. 50/60 Hz | |
| Display digits | -9999 ~ 9999 | |
| Functions | Operation mode (6), hysteresis, alternating current frequency measurement, zero adjustment, initialization, lower display deviation correction, key lock transmission output scale adjustment, start compensation timer, free scale, slope adjustment, error correction, display period delay, maximum/minimum monitoring, | |
| Input | · DV: DC voltage · DA: DC current · AV: AC voltage / frequency · AA: AC current / frequency | |
| Output | · Contact Output : 3-layer, SPST (1a), 250 V a.c. 5A · Contactless output : 3-speed, NPN/PNP, Open Collector, 12-24 V d.c. 50mA · Transmission Output (4~20 mA), RS485 Output | |
| Page | 75 | |

| Type | Digital Multi Panel Meters | Digital Frequency Meters | Digital Wattmeters |
|----------------|---|--|---|
| Model | MP3 / MP6 | MP3-4H / MP6-4H | WM3 |
| Appearance |   |   |   |
| Features | <ul style="list-style-type: none"> · RMS measurement · Multi input range · Wide display range, 4 digits (-1999 ~ 9999) | <ul style="list-style-type: none"> · Exclusive frequency meter · Frequency measurement by AC voltage input signal · Wide display range, 4 digits (-1999~9999) | <ul style="list-style-type: none"> · Effective power display by RMS measurement · Converter not needed with the voltage and current measurement method · Several outputs (Relay 4 - 20 mA d.c. open collector) |
| Power voltage | 100-240 V a.c. 50/60 Hz, 24 V d.c. (Nameplate type only) | 100-240 V a.c. 50/60 Hz | |
| Display digits | -1999 ~ 9999 | | |
| Functions | Scaling | Frequency meter (Hz) | Wattmete (W) |
| Input | Multi Input | Relay output | Single-phase 2-wire 220 V a.c. |
| Output | Relay (HI,GO,LO) transistor, 4 - 20 mA d.c., communication (RS485) BCD (Except MP6), display only | Relay (HI, GO, LO), transistor, 4 - 20 mA d.c., communication (RS485), display only | Display only, 4 - 20 mA d.c. relay (HI, GO, LO), transistor, communication (RS485) |
| Page | 76 | 81 | 79 |



| Type | Digital Scale Meters | Non-Power Scale Meters | Digital Voltmeter / Ammeters | |
|----------------|--|--|--|---|
| Model | HP3 | HLP1 | BS | BA1 |
| Appearance |  |  |  |  |
| Features | <ul style="list-style-type: none"> · High accuracy indicator ($\pm 0.03\%$ of F.S) · Max. display (-19999 ~ 19999) · Communication function (RS232 or RS485) selection | <ul style="list-style-type: none"> · Non-power free scale · High accuracy indicator ($\pm 0.3\%$ of FS) · Max. display (-1999 ~ 9999) · Current input (4-20mA d.c.) | <ul style="list-style-type: none"> · Bright and clear LED display · Cost-effective · Max. display 1999 · Average value measurement | <ul style="list-style-type: none"> · Bright and clear LED display · Cost-effective · Max. display 1999 |
| Power voltage | 100-240 V a.c. 50/60 Hz | Non-power | BS1: 100-240 V a.c. 50/60 Hz, BS3/6: 110/220 V a.c. 50/60 Hz (Common) | 5 V d.c., 12-24 V d.c. |
| Display digits | ± 19999 | -1999 ~ 9999 | ± 19999 | |
| Functions | Scale meter | | Polarity display (BS3) Indication value hold by external contact | Decimal point and polarity display over range indication |
| Input | 1 channel 1 - 5 V d.c., 4 - 20 mA d.c. | 4-20mA d.c. | 4 - 20 mA d.c. / 1 - 5 V d.c. AC voltmeter / AC ammeter/ DC voltmeter/ DC ammeter | 4 - 20 mA d.c. / 1 - 5 V d.c. DC voltmeter / DC ammeter |
| Output | 4 - 20 mA d.c. Alarm output 2 contacts | Indication only | Indication only | |
| Page | 82 | 83 | 80 | 84 |





Selection Table

■ Proximity Sensors



| Type | Inductive Round Type Proximity Sensors | Inductive Square Type Proximity Sensors | Inductive Flat Type Proximity Sensors | Capacitive Type Proximity Sensors |
|----------------------|--|--|--|---|
| Model | UP□R series | UP□S series | UP□F series | CUP series |
| Appearance |  |  |  |  |
| Features | <ul style="list-style-type: none"> Wide operating voltage (5-35 V d.c. : DC 3-wire) Noise resistant reinforced circuit 2-wire type nonpolar applied | <ul style="list-style-type: none"> Wide operating voltage (5-35 V d.c. : DC 3-wire) Noise resistant reinforced circuit 2-wire type nonpolar applied | <ul style="list-style-type: none"> Wide operating voltage Noise resistant reinforced circuit 2-wire type proximity nonpolar applied | <ul style="list-style-type: none"> Noise resistant reinforced circuit Leakage current less than 2 mA 20-240 V a.c. 50/60 Hz or 20-240 V d.c. |
| Power voltage | 12-24 V d.c., 100-240 V a.c. 50/60 Hz | | | 12-24 V d.c., 20-240 V a.c. 50/60 Hz or 20-240 V d.c. |
| Shield | Shield, Non shield | - | | Non shield |
| Sensing distance | 1.5, 2, 4, 5, 8, 10, 15 mm | 2, 4, 5, 8, 10, 12, 15, 20 mm | 8 mm | 8, 15 mm |
| Protective Structure | IP67 | | | |
| Page | 87 | 92 | 95 | 97 |

■ Photo Sensors



| Type | General Purpose Photo Sensors | Amplifier Built-In Photo Sensors | Flat Photo Sensors |
|----------------------|---|---|---|
| Model | PB series | PLD | PY series |
| Appearance |  |  |  |
| Features | <ul style="list-style-type: none"> 25.4mm standard mounting hole Hanyoung Nux new ASIC chip used (operation stability, long-distance detection) Built-in VR for sensitivity adjustment Excellent noise immunity and reduced disturbance of light influence Strong protection circuit | <ul style="list-style-type: none"> Power reverse connection and output short Diffuse-reflective type with 2 m of sensing distance 1 ms response time Sensitivity adjustment volume built-in | <ul style="list-style-type: none"> Light ON / Dark ON mode switching selection by control wire Power reverse connection and output short Convenient installation with the ultra slim size (16 X 28 X 8 mm) 1 ms response time Control output and stable output display |
| Power voltage | 12-24 V d.c. | | |
| Sensing mode | Through-beam, Diffuse-reflective, Retro-reflective (mirror), Retro-reflective (polarized mirror), Distance-settable | Diffuse-reflective | Through-beam |
| Sensing distance | 7 m, 10 m, 15 m, 0.1 - 3 m, 1 m, 100 mm, 400 mm | 2m | 3 m |
| Operating mode | Light ON, Dark ON | Light ON | Light ON, Dark ON |
| Operating mode | Max. 1 ms | | |
| Protective Structure | IP65 | IP64 | IP67 |
| Page | 99 | 105 | 100 |

| Type | Voltage Output Photo Sensors | Round Photo Sensors | U-Shaped Fast Response Photo Sensors | Long Distance Detection Photo Sensors |
|----------------------|--|--|--|---|
| Model | PN series | PR series | PU series | PEN series |
| Appearance |  |  |  |  |
| Features | <ul style="list-style-type: none"> Power reverse connection and output short circuit protecting circuit built-in Motion display light attached Sensitivity adjustment volume attached | <ul style="list-style-type: none"> Output cutoff over current protecting circuit built-in Sensitivity adjustment volume attached Light ON / Dark ON selection | <ul style="list-style-type: none"> Solid die casting case Optic axis control not needed Sensitivity adjustment volume attached Operating mode selection by power polarity reverse connection | <ul style="list-style-type: none"> Long distance detection Stability indication |
| Power voltage | 12-24 V d.c. | | | 24-240 V a.c. 50/60 Hz or 24-240 V d.c. |
| Sensing mode | Through-beam, Diffuse-reflective, Retro-reflective | | Through-beam | Through-beam, Diffuse-reflective, Retro-reflective |
| Sensing distance | 3 m, 0.1 - 1 m, 200 mm | 7 m, 10 m, 0.1~2 m, 0.1 m, 0.4m | 30 mm, 50 mm | 10 m, 0.1 - 5 m, 700 mm |
| Operating mode | Light ON, Dark ON | | | |
| Response time | Max.3 ms | Max.1 ms | Max.1 ms | Max.20 ms |
| Protective Structure | - | IP66 | IP65 | IP64 |
| Page | 101 | 102 | 103 | 107 |



■ Photo Sensors

| Type | Power /Amplifier Built-In Photo Sensors | Power Built-In Photo Sensors | Distance-settable Photo Sensors |
|----------------------|--|---|---|
| Model | PTX series | PE series | PL-D2B |
| Appearance |  |  |  |
| Features | <ul style="list-style-type: none"> Terminal block type connection for convenient wiring Wide power voltage range Timer function available NPN/PNP open collector simultaneous output with DC power | <ul style="list-style-type: none"> Cost-effective Wide power voltage Relay output Operation status indication attached Lower impact of dust with the flat lens | <ul style="list-style-type: none"> Distance setting reflective type by 2 split photo diodes Power reverse connection and output short circuit protective circuit built-in |
| Power voltage | 24-240 V a.c. 50/60 Hz or 24-240 V d.c. | 24 V d.c., 100-240 V a.c. 50/60 Hz or 100-240 V d.c. | 12-24 V d.c. |
| Sensing mode | Through-beam , Diffuse-reflective, Retro-reflective | | Distance-settable |
| Sensing distance | 15 m, 7 m, 1 m | 5 m, 0.1 - 3 m, 500 mm | 0.2 - 2 m |
| Operating mode | Light ON , Dark ON | | |
| Response time | Power built-in type : max. 20 ms Amplifier built-in type : max. 1 ms | Max.25 ms | Max.2 ms |
| Protective Structure | IP66 | IP54 | IP65 |
| Page | 104 | 103 | 106 |

■ Fiber Optic Sensors

| Type | Fiber Optic Sensors | | Multi-Function Digital Fiber Optic Sensors |
|----------------------|---|--|--|
| Model | PG series | PFB | PFD |
| Appearance |  |  |  |
| Features | <ul style="list-style-type: none"> Applicable to any application with the AMP unit 4 type and several fiber unit types. Easy to install to a 35 mm wide DIN rail, so less installing space is needed. | <ul style="list-style-type: none"> Sensitivity setting by auto-teaching External teaching input/external synchronous input Output delay time (40 ms fixed) Light ON/ Dark ON selection by slide switch | <ul style="list-style-type: none"> Sensitivity setting by auto-teaching 7-Segment 4-digit LED display Mark detection/ counter / tachometer functions (multi-type) Output delay time setting(1~9999 ms) |
| Power voltage | 12-24 V d.c. | | |
| Sensing mode | Through-beam, Diffuse-reflective | | |
| Sensing distance | By fiber optic cable | | |
| Operating mode | Light ON , Dark ON | | |
| Response time | Max. 1 ms | | RM : Max. 1 ms, RG : Max. 0.7 ms |
| Protective Structure | IP40 | IP40 | IP40 |
| Page | 108 | 110 | 109 |

■ Area sensors



| Type | Area Sensors | Area Sensors |
|----------------------|---|---|
| Model | PAS series | PAN series |
| Appearance |  |  |
| Features | <ul style="list-style-type: none"> Less installation space (thickness : 13.5 mm, width : 30 mm) Automatic sensitivity correction function built-in Minimum sensing object (Ø30 mm) | <ul style="list-style-type: none"> Several optical axis distances(20/40 mm) Output short circuit protection circuit built-in Operating mode selection (all optical axes/1 optical axis light ON) |
| Power voltage | 12-24 V d.c. ±10% ripple (p-p) 10% or less | |
| Sensing mode | Through-beam | |
| Sensing distance | 5 m | 7 m |
| Operating mode | Light ON or Dark ON | Emitter : M/S mode switch switching type (Master / Slave) Receiver : D/L mode switch switching type (Dark ON, Light ON) |
| Response time | Max. 7 ms | Max. 15 ms |
| Protective Structure | IP40 (IEC Specification) | IP65 (IEC Specification) |
| Page | 111 | 112 |

■ Sensor Controllers





| Type | Sensor Controllers |
|-----------------------|--|
| Model | HPA-12 |
| Appearance |  |
| Features | <ul style="list-style-type: none"> NPN/PNP dual usage input sensor controller Solid output contact (250 V 3 A, more than 100,000 times) Convenient installation with plug in method |
| Power voltage | 220 V a.c. 50/60 Hz |
| Functions | Universal |
| Power consumption | Approx. 4 VA |
| External output power | 12 V d.c., ± 10 %, 50 mA max. |
| Output | Relay 1c, 250 V a.c., 3A (resistive load) |
| Page | 113 |

Selection Table





■ Sensor Controllers

| Type | Universal | High function (timer) | For connection of 2 connections. |
|-----------------------|---|---|---|
| Model | HPAN-C7 | HPAN-CT7 | HPAN-C7W |
| Appearance |  |  |  |
| Features | · Contact/contactless, 2 outputs built-in (HPAN-C7, HPAN-CT7) · For connecting 2 sensor · Corresponds to DIN rail | | |
| Power voltage | 100-240 V a.c. 50/60 Hz ±10 % | | |
| Functions | 2 inputs 1 output | | 2 inputs 2 output |
| Power consumption | Approx. 5 VA | | |
| External output power | 12 V d.c. (± 10 %), load current : max. 200 mA | | |
| Output | Contact | OUT 1 | |
| | Contactless | OUT 1, OUT 2 | |
| | Relay 1 c, 250 V a.c., 3A (resistive load) ※ HPAN - C7W (1 c X 2 relay contact) | | |
| | NPN open collector 30 V d.c., Max. 200 mA | | - |
| Page | 113 | | |





■ Rotary Encoders

| Type | Ø30, Ø40, Ø50 Shaft Type | Ø40 Hollow Shaft Type | Ø40 Blind Shaft Type | Wheel Type |
|-------------------------|---|---|---|---|
| Model | HE30B, HE40B, HE50B | HE40H | HE40HB | PSC |
| Appearance |  |  |  |  |
| Features | · Wide power voltage (5 - 12 / 12 - 24 V d.c.) · Several output specifications · Convenient installation structure | · Wide power voltage (5-12 V d.c. / 12-24 V d.c.) · Several output specifications · Convenient installation structure | · Wide power voltage (5-12 V d.c. / 12-24 V d.c.) · Several output specifications · Convenient installation structure | · The wheel type detection structure is suitable for length and speed measurement · Several measuring units (6 types) · Convenient installation structure |
| Power voltage | 5-12 V d.c.±5 %, 12-24 V d.c.±5 %, 5 V d.c.±5 % | | | 5-12 V d.c.± 5 %, 12-24 V d.c.±5 %, 5 V d.c.± 5 % |
| Output phase difference | Phase difference between A, B phases : T/4±T/8 (1 cycle of A phase=T) | | | |
| Response time | Max.1 μs | | | |
| Number of pulses | 1, 2, 5, 10, 12, 15, 20, 25, 30, 40, 45, 50, 60, 75, 100, 120, 125, 150, 192, 200, 240, 250, 256, 300, 360, 400, 500, 512, 600, 800, 1000, 1024 | | | According to the minimum measured length |
| Page | 114 | 115 | 116 | 117 |



■ Thyristor Power Regulators





| Type | 3-Phase Power Regulator | Small single-phase power regulator | | Small 3-phase power regulator |
|---------------|--|---|---|---|
| Model | TPR-3 | TPR-2G | TPR-2M | TPR-3M |
| Appearance |  |  |  |  |
| Features | · Status indication with 9 LEDs · Various alarm functions · Soft start / Soft down · Built-in fast fuse | · TPR-2N compliant · An economical price · Slim Size · Phase Control, Cycle Control (Order Specification) · Various alarm verification functions (50A/70A only) | · Several protection functions (heater break, overcurrent, heat sink overheating, SCR short circuit, etc) · Improved safety by of circuit power supply and load power supply separation (free voltage) · SOFT START(60sec), SOFT UP/DOWN(15sec) | · 110 mm (width) small 3-phase slim type thyristor power regulators · Improved safety with the separate power supply · 4 LEDs to check operation status and alarm · Several alarm functions. "Caution" and "warning" alarm separation. |
| Power voltage | 220 V a.c., 380 V a.c. / 440 V a.c. | 220 V a.c. 50/60 Hz, 380 V a.c. 50/60 Hz | 100-240 V a.c. 50/60 Hz, 100-440 V a.c. 50/60 Hz | 100-240 V a.c. 50/60 Hz |
| Rated current | 200 A, 250 A, 320 A, 500 A | 25 A, 35 A, 50 A, 70 A | 25 A, 35 A | 25 A, 45 A |
| Control type | Phase control, ON/OFF control | Phase control (Shipment Mode), Fixed cycle control(Optional), Variable cycle control(Optional) | Phase control (standard), Variable cycle control (optional) | Phase control, Fixed cycle control (Option) Variable cycle control (Option) |
| Page | 118 | 119 | 120 | 121 |

Selection Table



| Type | Slim Type Single-Phase Thyristor Power Regulators | 3-Channel Each Phase Control Thyristor Power Regulators | | Slim Type 3-Phase Thyristor Power Regulators |
|---------------|--|---|--|--|
| Model | TPR-2SL | TPR-3SL-EP | TPR-3CH-EC | TPR-3SL |
| Appearance |  |  NEW |  NEW |  |
| Features | <ul style="list-style-type: none"> Alarm output divided into caution and warning Several Control types available depending on load Several protection functions Improved safety by of circuit power supply and load power supply separation (free voltage circuit) | <ul style="list-style-type: none"> 3 individual phase controls available in one product Setting and monitoring with RS485 communication Load input power single-phase, and 3-phase available. Free voltage available (100-440 V a.c) Several protection functions | <ul style="list-style-type: none"> 3 individual phase controls available in one product Set up and monitor with Ether CAT communication Load input power single phase, all three phases possible Various protection features | <ul style="list-style-type: none"> The slimmest type among 3-phase thyristor power regulators under the same rating (110 mm) The heat sink excellent design and several protection circuits provide high durability. Improved safety with the separation of circuit power supply and load power supply Several alarm functions |
| Power voltage | 100-240 V a.c. 50/60 Hz, 380-440 V a.c. 50/60 Hz | 100-240 V a.c. 50/60 Hz, 100-440 V a.c. 50/60 Hz | | 100-240 V a.c. 50/60 Hz, 380-440 V a.c. 50/60 Hz |
| Rated current | 25 A, 40 A, 55 A, 70 A, 90 A, 110 A, 130 A, 160 A, 200 A | 40 A, 55 A, 70 A, 90 A, 130 A, 160 A | | |
| Control type | Phase control, cycle control, ON/OFF control (dip switch selection) | Phase control, fixed cycle control, variable cycle control, ON/OFF control | | |
| Page | 122 | 123 | 124 | 125 |

■ Solid State Relays



| Type | Single-phase contactless relay | Tri-phase contactless relay | Single-Phase Solid State Relays For PCB Substrate |
|--------------------|---|--|--|
| Model | SSR-2B/2C | SSR-3F | HSR-PD |
| Appearance |  NEW |  NEW |  |
| Features | <ul style="list-style-type: none"> B Contact Alarm Output SSR-2C (2 contacts) 60 °C / 80 °C Temperature detection prevents overheating SSR-2B (Bimetal Three Contact) 80 °C Temperature detection prevents overheating | <ul style="list-style-type: none"> Overcurrent detection function Load Power Contingency Detection Various alarm functions Zero-cross switching enables precise control (optional) | <ul style="list-style-type: none"> High insulation between input and output Compact, lightweight, with large capacity High reliability as non-contact Zero cross switching |
| Input voltage | 4-32 V d.c. | 24 V d.c. | 4-32 V d.c. |
| Rated load current | 25 A, 40 A | 25 A, 35 A, 45 A | 3 A, 5 A |
| Load voltage | 90-264 V a.c. 50/60 Hz | | 90-240 V a.c. 50/60 Hz |
| Page | 126 | 131 | 139 |

| Type | Single-Phase Solid State Relays | | 3-Phase Solid State Relays | |
|--------------------|--|--|---|--|
| Model | SSR-2 | HSR-2 | SSR-3 | HSR-3 |
| Appearance |  NEW |  |  NEW |  |
| Features | <ul style="list-style-type: none"> Terminal protection cover for safety Operation check by operation indicator (red LED) Zero cross switching/ random switching | <ul style="list-style-type: none"> High insulation between input and output High reliability as non-contact C-R Snubber, Zero cross switching | <ul style="list-style-type: none"> Terminal protection cover for safety Operation check by operation indicator (red LED) Zero cross switching / random switching | <ul style="list-style-type: none"> High insulation between input and output High reliability as non-contact C-R Snubber, Zero cross switching |
| Input voltage | 4.6-32 V d.c., 70-264 V a.c. | 4-32 V d.c., 90-264 V d.c. | 4.6-32 V d.c., 70-264 V a.c. | 4-32 V d.c., 90-264 V d.c. |
| Rated load current | 10 A, 20 A, 30 A, 40 A | 10 A, 20 A, 30 A, 40 A, 50 A, 70 A | 10 A, 20 A, 30 A, 40 A | 10 A, 20 A, 30 A, 40 A, 50 A, 70 A |
| Load voltage | Low pressure : 90-264 V a.c. 50/60 Hz, | | High pressure : 90-480 V a.c. 50/60 Hz | |
| Page | 127 | 129 | 132 | 134 |

Selection Table

| Type | Slim Type Single-Phase Solid State Relays | 2-Wire Cutoff Solid State Relays | Slim Type 3-Phase Solid State Relays |
|-------------------------|--|--|--|
| Model | HSR-SL | HSR-2SLD / SE | HSR-3SL |
| Appearance |  |  |  |
| Features | <ul style="list-style-type: none"> · 22.4 mm Slim Type · Load voltage 90 - 264 V a.c. / 90 - 480 V a.c. · High insulation between input and output · C-R Snubber, Zero cross switching | <ul style="list-style-type: none"> · Status indication with several LED displays · Control each phase simultaneously with the 2-wire disconnection function · When the temperature of heat sink is 60 °C / 80 °C, the alarm output works and operation stops · It has the mandatory functions required from FPD industry | <ul style="list-style-type: none"> · Improved safety and working convenience with the heat sink one-body type · Can be installed in small spaces with the small design · It is the slimmest type among the 3-phase solid state relays under the same rating (79 mm) |
| Operating voltage range | 4-32 V d.c. | | |
| Rated load current | 15 A, 25 A, 40 A | 25 A, 40 A | 15 A, 25 A, 40 A |
| Load voltage | Low pressure: 90-264 V a.c. 50/60 Hz, High pressure: 90-480 V a.c. 50/60 Hz | | |
| Page | 136 | 137 | 138 |

Power Supplies

| Type | DIN Rail Type Power Supplies | Enclosed type Power Supplies | Small Rail Type | | | | | | | | |
|--|---|---|---|---------|--|--|-------------------------------|--|--|------------|---|
| Model | DPS | TPS | HNPS | | | | | | | | |
| Appearance |  |  |  | | | | | | | | |
| Features | <ul style="list-style-type: none"> · 35 mm width DIN Rail installation method · Low output voltage fluctuation · High efficiency and low heat generation · Overcurrent, overvoltage, overheating protection functions | <ul style="list-style-type: none"> · Input inrush current limit · Output voltage adjustable volume · Overcurrent/overvoltage/short circuit protection/overheating protection | <ul style="list-style-type: none"> · Easy Rail Installation(DIN) · Output Voltage Variable · Overcurrent Protection · Input Inlet Current Limit | | | | | | | | |
| Power output | <table border="1"> <tr> <td>1output</td> <td>15 W, 30 W, 50 W,</td> </tr> <tr> <td>2output</td> <td>75 W, 100 W, 120 W, 180 W, 216W, 240 W</td> </tr> </table> | 1output | 15 W, 30 W, 50 W, | 2output | 75 W, 100 W, 120 W, 180 W, 216W, 240 W | <table border="1"> <tr> <td>15 W, 30 W, 50 W, 75 W, 100 W</td> </tr> <tr> <td>55 W, 100 W, 150 W, 220 W, 230 W, 350 W, 450 W</td> </tr> </table> | 15 W, 30 W, 50 W, 75 W, 100 W | 55 W, 100 W, 150 W, 220 W, 230 W, 350 W, 450 W | <table border="1"> <tr> <td>3 W, 7.5 W</td> </tr> <tr> <td>-</td> </tr> </table> | 3 W, 7.5 W | - |
| 1output | 15 W, 30 W, 50 W, | | | | | | | | | | |
| 2output | 75 W, 100 W, 120 W, 180 W, 216W, 240 W | | | | | | | | | | |
| 15 W, 30 W, 50 W, 75 W, 100 W | | | | | | | | | | | |
| 55 W, 100 W, 150 W, 220 W, 230 W, 350 W, 450 W | | | | | | | | | | | |
| 3 W, 7.5 W | | | | | | | | | | | |
| - | | | | | | | | | | | |
| Input voltage | 100-240 V a.c., 100-120 V a.c., 200-240 V a.c. | | 100-240 V a.c. 50/60 Hz | | | | | | | | |
| Output voltage | 5 V, 12 V, 15 V, 24 V, 48 V | 5 V, 12 V, 15 V, 24 V, 48 V, 24/05 V, 24/12 V, 24/24 V | 5 V, 12 V, 15 V, 24 V | | | | | | | | |
| Voltage fluctuation range | ± 5 ~ 10 % (According to internal VR) | | ± 10 % (Variable by volume : V.ADJ) | | | | | | | | |
| Protection circuit | Overcurrent, overvoltage, overheating, output short-circuit protection | | Overcurrent protection | | | | | | | | |
| Dielectric strength | 2,700 V a.c. 1 min (Input - Output) | | 3 kVAC (Input - Output to), 1.5 kVAC (Input - Between FG), 500 V a.c. (Output to FG), (Detection current : 10 mA, to 1 min) | | | | | | | | |
| Page | 141 | 140 | 142 | | | | | | | | |



Control Switches

| Type | Ø 22, Ø 25, Ø 30 Advanced LED Switch | Ø 25, Ø 30 Affordable LED Switch | Ø 16, Ø 22 Small LED Switch |
|---------------------|---|---|--|
| Model | MR | CR | DR |
| Appearance |  |  |  |
| Features | <ul style="list-style-type: none"> · 3 aluminum guard and 2 plastic guard types provide wide configuration possibilities · Double break snap action open / close contacts with self-diagnosis function for high contact reliability | <ul style="list-style-type: none"> · 1a1b one-body type · Long life with the bright LED light source · Convenient product configuration with the modular actuators and contacts · High contact reliability with the slow-make contact point and self-diagnosis function | <ul style="list-style-type: none"> · 1a1b one-body type · Long life with the bright LED light source · The control and contact parts are modular and convenient to configure the product. |
| Type | Push buttons, illuminated push buttons, pilot lamps, selectors, key selectors, illuminated selectors, emergency switches, illuminated emergency switches, buzzers | Push buttons, illuminated push buttons, pilot lamps, selectors, key selectors, emergency switches | Push buttons, illuminated push buttons, pilot lamps, selectors, key selectors, illuminated selectors, emergency switches, illuminated emergency switches |
| Power voltage | 100-240 V a.c. 50/60 Hz, 380 V a.c. 50/60 Hz, 12-24 V a.c. 50/60 Hz or 12-24 V d.c. | | 100-240 V a.c. 50/60 Hz, 12-24 V a.c. 50/60 Hz or 12-24 V d.c. |
| Dielectric strength | 2,000 V a.c. for 1 min | 1,500 V a.c. 60 Hz for 1 min | 1500 V a.c. 50/60 Hz for 1 min |
| Page | 147 | 145 | 143 |



Control Switches

| Type | Ø22, Ø25 Combined LED Switch |
|---------------------|--|
| Model | AR |
| Appearance |  |
| Features | <ul style="list-style-type: none"> Elegant European design Easy to attach and detach actuators and contacts Ø22, Ø25 Dual usage |
| Type | Push buttons, illuminated push buttons, pilot lamps, selectors, illuminated selectors, key selectors, emergency switches |
| Power voltage | 110 V a.c. 50/60 Hz, 220 V a.c. 50/60 Hz |
| Dielectric strength | 2,000 V a.c. for 1 min (among pole terminals) |
| Page | 149 |



Combination Display Lights

| Type | LED Square Indicators | LED Combination Display Lights |
|---------------------|--|--|
| Model | CR40 | CDN |
| Appearance |  |  |
| Features | <ul style="list-style-type: none"> Display surface size 40 X 32 mm Bright LED light source Convenient individual mounting, gathered / assembled mounting Gathered / assembled mounting by the + appearance connector (Die casting) | <ul style="list-style-type: none"> Display surface size 30 X 30 mm, 30 X 40 mm 2 Type 6 Indicating colors Simple assembling. Able to change the colors on the spot Max. 200 compositions (10 rows, 20 columns) |
| Power voltage | 100-240 V a.c. 50/60 Hz, 380 V a.c. 50/60 Hz, 12-24 V d.c. | 110/220 V a.c. 50/60 Hz, 24 V a.c. 50/60 Hz or 24 V d.c. |
| LED Display Color | Red, green, yellow, blue, white | Red, green, yellow, white, orange, blue |
| Dielectric strength | 1,500 V a.c. for 1 min | 2,000 V a.c. for 1 min |
| Page | 150 | |

Power Switches

| Type | Power Switches | |
|-----------------|--|---|
| Model | HY-500 | BE |
| Appearance |  |  |
| Features | <ul style="list-style-type: none"> Directly turn ON/OFF the power of compact electric motor Exposed type/flush type, plastic/cold rolled steel case Push buttons for turning ON/OFF electric motors (forward, reverse operations) Lamp power ON/OFF switch mounting type Electrical appliances safety certification | <ul style="list-style-type: none"> Directly turn ON/OFF the power of compact electric motor Exposed type/flush type, plastic/cold rolled steel case Push buttons for turning ON/OFF electric motors (forward, reverse operations) Waterproof non-flammable ABS Plastic Case |
| Rated capacity | 250 V a.c. 15A | 440 V a.c. 15 ~30 A |
| Display legends | ON, OFF, FOR, STOP, REV | |
| Case material | Cold rolled steel case, Plastic | Cold rolled steel case, Non-flammable ABS |
| Page | 151 | |

Cam switches



| Type | Cam switches | |
|--------------------------|--|---|
| Model | HY-SQ5/255/305/MRK | SQ4 |
| Appearance |  |  |
| Features | <ul style="list-style-type: none"> HY-SQ5 /305/255 series Several surfaces (square, Ø25 round, Ø30 round) Switch-board switch A/S, V/S, C/S standard manufacturing product Machine tools and electrical installation custom circuit configurations for every industry HY-MRK Handle lock function by key lock Rated current 20 A, high capacity cam switches/custom circuit configuration | <ul style="list-style-type: none"> Small Cam switches (48 X 48 mm) 2 operation handles (H type, R type) Ammeter switch (AS), Voltmeter switch (VS) Small cam switches with several circuit configurations |
| Rated insulation voltage | 600 V | 690 V a.c. |
| Rated current | 10 A | 16A-24 V a.c., 8A-48 V a.c., 5A-110 V a.c., 3A-220 V a.c., 1.8A-380 V a.c. |
| Dielectric strength | 2,500 V a.c. for 1 min | |
| Page | 153 | 152 |

Main Switches



| Type | Main Switches |
|--------------------------|--|
| Model | MAS |
| Appearance |  |
| Features | <ul style="list-style-type: none"> Designed as rapid switching structure for excellent contact reliability Lock ring applied in the OFF state Handle and contact parts with detachable structure (MAS-025) 2 color types of handle and handle guard (red/yellow and black/white) Ø22, Ø30 (MAS-025), 4 holes fixed panel mounting Clear indication of ON/OFF contact status (turning OFF the operation handle will block all contacts) |
| Rated insulation voltage | 690 V a.c. |
| Rated current | 25 A, 63 A, 125 A |
| Materials | Non-flammable |
| Page | 152 |

Selection Table

■ Limit Switches

| Type | Aluminum Die Casting | Zinc Die Casting | Plastic Case |
|-----------------------|---|--|--|
| Model | HY-M900 | HY-L800 | HY-LS800 |
| Appearance |  |  |  |
| Features | <ul style="list-style-type: none"> · Solid die casting case and 2 circuits double micro switch built-in · High mechanical intensity with the heat resistant, oil proof and dust protection structure · Check the operation state on the outside with the operation indicator | <ul style="list-style-type: none"> · Zinc die casting body and plastic cover structure · 4 actuator types provide wide selection possibilities · Applicable to machine tools, transportation machines, assembling lines and several industrial machines | <ul style="list-style-type: none"> · Compact size and lightweight with the plastic case · The plastic case is safe against electric leakage · 6 actuator types provide wide selection possibilities |
| Open/close frequency | Mechanical: 120 times/min, electrical: 20 times/min | Mechanical: 120 times/min, electrical: 30 times/min | |
| Insulation resistance | Min. 100 MΩ (500Vd.c.) | | |
| Dielectric strength | Among terminals : 1000 V a.c. 50/60 Hz for 1 min, Among unfilled metal parts : 1500 V a.c. 50/60 Hz for 1 min | Among terminals : 1500 V a.c. 50/60 Hz for 1 min, Among unfilled metal parts : 2000 V a.c. 50/60 Hz for 1 min | 1,000 V a.c. 50/60 Hz for 1 min, 2,000 V a.c. 50/60 Hz for 1 min |
| Page | 154 | 154 | 155 |

■ Micro Switches

| Type | Micro Switches | |
|-----------------------|---|---|
| Model | HY-700 | ZCN-500 |
| Appearance |  |  |
| Features | <ul style="list-style-type: none"> · Certain operation and long life with the snap action tool · Excellent repetitive accuracy and 10 A open/close capacity · Standard type, installation hole gap: 25.4 mm, fixed with M4 bolt · 9 actuator types provide wide selection possibilities · Terminal protective cover (optional) | <ul style="list-style-type: none"> · Certain operation and long life with the beryllium copper and running spring to the strong chemically resistant resin case. · Compact, lightweight, with strong mechanical durability · 9 Actuator types provide wide selection possibilities |
| Open/close frequency | Mechanical: 120 times/min, Electrical: 20 times/min | |
| Insulation resistance | Min. 100 MΩ (500 V d.c.) | |
| Rated current | 10 A 250 V a.c. | |
| Page | 156 | 155 |

■ Foot Switches

| Type | Foot Switches |
|-----------------------|---|
| Model | HY-100 |
| Appearance |  |
| Features | <ul style="list-style-type: none"> · High mechanical safety with the aluminum case · Micro switch with excellent electrical reliability built-in · Protective cover from falling materials and safety latch lever attached. (HY-104) · Cable locker applied (HY-103, 104) · Cost-effective plastic case (HY-101) |
| Rated current | 10 A 250 V a.c. |
| Foot switch materials | Plastic, aluminum |
| Contact structure | C Contact |
| Page | 157 |



■ Mono Lever Switches



| Type | Mono Lever Switches |
|--------------------------|---|
| Model | LEL/LES |
| Appearance |  |
| Features | <ul style="list-style-type: none"> · 4-direction switches that can operate 4 directions in a single lever · The lever tilting direction minimizes malfunctions during use and it is suitable for products that are frequently switched in direction. · There are auto returning, manual returning and mixed types depending on lever operation type. |
| Rated insulation voltage | 600 V |
| Rated electric current | 3 A 250 V a.c. |
| Dielectric strength | 2,500 V a.c. for 1 min |
| Page | 157 |

■ Pendant Switches

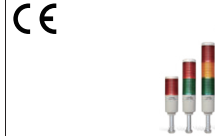

| Type | Pendant Switches |
|-----------------------|---|
| Model | HY-P series |
| Appearance |  NEW |
| Features | <ul style="list-style-type: none"> · Easy wiring and operation with the wire holder bending structure (15°) · Solidity improved with the thicker high impact ABS resin, and anti-slip structure · The wide internal wiring space makes wiring easier and more convenient · Several new features on-demand (LED, volume, toggle switch). |
| Degree of protection | IP-65 (IEC 60529) (emergency switch type included) |
| Materials | Case : high impact ABS, Contacts : AgSnO2 |
| Insulation resistance | Min. 100 MΩ (500 V d.c.) |
| Page | 158 |

■ Sign Towers

| Type | Ø25 Modular LED Sign Towers | | Ø60 Modular LED Sign Towers | | Ø55 Sign Towers | |
|---------------------------|---|--|---|--|--|--|
| Model | STE025 | | STE060 | | HY-TN | |
| Appearance |  | |  | |  | |
| Feature | <ul style="list-style-type: none"> · Ø25 column type, suitable installation structure for small machines and narrow spaces · Long life with high brightness LED light source · 1~3 stacks and 3 color types · Easy installation with pipe direct installation structure | | <ul style="list-style-type: none"> · Long life with the high brightness LED light source · Simple structure from 1 to 5 stacks · Several mounting supporters · Convenient configuration (number of stacks and colors) with the modular type | | <ul style="list-style-type: none"> · Ø55 round type · 1~5 stacks and 5 color types · Incandescent bulb type | |
| Function | Continuous light only | | Continuous light, continuous light/flashing/buzzer (selection by external signal) | | | |
| Diameter | Ø25 | | Ø60 | | Ø55 | |
| Supporter | L type bracket (sold separately) | | Plastic round supporter, L type bracket, elbow type supporter (optional) | | Plastic round supporter, L type bracket, elbow type supporter (optional), Plastic supporter with pipe connection | |
| Rated voltage | 24 V d.c. | | 24 V d.c., 100-240 V a.c. 50/60 Hz | | 24 V d.c., 220 V a.c. 50/60 Hz | |
| Number of stacks & colors | 1~3 stacks (red, green, yellow) | | 1~5 stacks (red, green, yellow, blue, white) | | | |
| Page | 165 | | 164 | | 163 | |

| Type | Ø40, Ø60, Ø80 LED Sign Towers | | Ø25, Ø40, Ø60, Ø80 LED Sign Towers | |
|---------------------------|--|--|---|--|
| Model | STS | | STL | |
| Appearance |  | |  | |
| Features | <ul style="list-style-type: none"> · Several sizes (Ø40, Ø60, Ø80) · Long life with the high brightness LED light source · 1~5 stacks and 5 color types · 3 installation types | | <ul style="list-style-type: none"> · Several sizes (Ø25, Ø40, Ø60, Ø80) · 1~5 stacks and 5 color types · Convenient installation with the aluminium pipe direct installation structure | |
| Function | Continuous light only | | Continuous light/flashing/buzzer models (selection by external signal) | |
| Diameter | Ø40, Ø60, Ø80 | | Ø25, Ø40, Ø60, Ø80 | |
| Supporter | Plastic round supporter, L type bracket, elbow type supporter (optional) | | Plastic round supporter, L type bracket, elbow type supporter (optional) | |
| Rated voltage | 24 V a.c. 50/60 Hz or 24 V d.c., 12 V a.c. 50/60 Hz or 12 V d.c. (Order-made) | | 24 V d.c., 24 V a.c. 50/60 Hz or 24 V d.c., 100-240 V a.c. 50/60 Hz | |
| Number of stacks & colors | 1~5 stacks (red, green, yellow, blue, white) | | | |
| Page | 161 | | 162 | |

■ Indicating Lights



| Type | LED Wall Mounted Lights | |
|-----------------------------|--|--|
| Model | WME | WMS |
| Appearance |  |  |
| Features | <ul style="list-style-type: none"> · 3-color slim type, suitable for wall mounting · Long life with the high brightness LED light source · 2 body type: beige or chrome plated · Continuous light, flashing light, 2-melody buzzer built-in · Degree of protection IP54 (IEC 60529) | <ul style="list-style-type: none"> · 1~5 stacks, suitable for wall mounting · Long life with the high brightness LED light source · 2 types of buzzer melodies (single melody/beeping) · Continuous light, flashing light · Degree of protection IP54 (IEC 60529) |
| Rated voltage | 24 V a.c. 50/60 Hz or 24 V d.c., 12 V a.c. 50/60 Hz or 12 V d.c. (Order-made) | |
| Functions | Continuous light · flashing · buzzers | |
| Number of stacks and colors | 3 Tires Red, Green, Yellow | 1~5 Tires Red, Green, Yellow, Blue, White |
| Page | 166 | |

■ Panel lamp

| Type | LED Basic Panel Lamp |
|-----------------------------|---|
| Model | HL |
| Appearance |  |
| Features | <ul style="list-style-type: none"> · Easy to install in tight spaces · Protection from obstruction through an internal protection circuit. · Improved cost-effectiveness through non-insulated SMPS methods · High Efficiency LED Recruitment (using LG Innotec G3 series LEDs) |
| Rated voltage | 220 V a.c. |
| Number of stacks and colors | Light Color |
| Page | 165 |

Selection Table



Turn Lights

| Type | Signal Lights (Xenon) | Ø84 LED Signal Lights | Ø70 LED Signal Lights |
|---------------|--|---|---|
| Model | RLA-WX/WXB | LT | SLB |
| Appearance |  |  |  |
| Features | <ul style="list-style-type: none"> · Ø118 Rotating continuous light only, rotating continuous light and buzzers built-in · Excellent instant light emitting and high brightness · Less current consumption compares to the rotating light and 4 times longer life expectancy compared to the regular lamp · Simple attaching/detaching due to the permanent magnet attachment type (for cars) · Degree of protection IP54 (IEC 60529) | <ul style="list-style-type: none"> · Rotational flickering function by the sequential flashing · Long life with the high brightness LED light source · Ø84 round cap, direct or supporter mounting · Acrylic cap for excellent visible light transmittance · Solid and smart design · Degree of protection IP54 (IEC 60529) | <ul style="list-style-type: none"> · Continuous light, flashing light, buzzer (selection by external signal) · Long life with the high brightness LED light source · Select Ø70 round type cap, rectangular type cap, direct installation, supporter mounting installation · Cost-effective, simple installation structure · Solid polycarbonate protective cap · Degree of protection IP54 (IEC 60529) |
| Diameter | Ø118 | Ø84 | Ø70 |
| Rated voltage | 110 V a.c. 50/60 Hz, 220 V a.c. 50/60 Hz, 12 V d.c., 24 V d.c. | 12-24 V a.c. 50/60 Hz, 110/220 V a.c. 50/60 Hz, 12-48 V d.c. | 12 V a.c. 50/60Hz or 12 V d.c., 24 V a.c. 50/60 Hz or 24 V d.c., 110-240 V a.c. 50/60 Hz |
| Functions | Rotating continuous light · buzzers | Rotating continuous light · Flashing · Buzzer built-in | Lit, flashing, buzzer (selected by external input signal) |
| Colors | Red, blue, white | Red, yellow, green, blue | Red, yellow, green |
| Page | 168 | 169 | 169 |

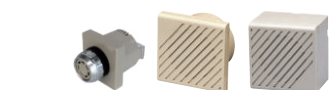

Warning Lights

| Type | Ø60 / Ø84 / Ø100 / Ø150 Revolving Warning Lights | | | | | |
|---------------|---|-------------|----------------------------|---|----------------------------|--------------------|
| Model | T060 / T084 | T060 / T084 | T060 / T084 T100 / T150 | T060 / T084 / T100 | T060 / T084 T100 / T150 | T060 / T084 / T100 |
| Appearance |  | | | | | |
| Features | <ul style="list-style-type: none"> · Ø60 / Ø84 / Ø100 / Ø150 Rotating continuous light, rotating continuous light and buzzers · High luminance LED light source bright and long life · Several supporter mounting type · Cost-effective, simple installation structure · Solid polycarbonate protective cap · Rotational structure with the excellent abrasion resistive acetal gear · Degree of protection IP54 | | | | | |
| Diameter | Ø60, Ø84, Ø100, Ø150 | | | | | |
| Rated voltage | ● 12 V d.c. : 0.08 A, ● 24 V d.c. : 0.06 A, ● 110 - 220 V a.c. : 0.03 A | | | ● 12 V d.c. : 0.09 A, ● 24 V d.c. : 0.07 A, ● 110 - 220 V a.c. : 0.04 A | | |
| Functions | Rotating continuous light · buzzers | | | | | |
| Colors | Red, Yellow, Green, Blue | | | | | |
| Page | 167 | | | | | |

Buzzers

| Type | Power Buzzers | 4-Tone Buzzers | 3-Tone Electronic Buzzers |
|-----------------------|--|--|---|
| Model | HY-256/306/606/606N | HY-606MD/MA | HY-226M/256M |
| Appearance |  |  |  |
| Features | <ul style="list-style-type: none"> · Compact size, lightweight, high capacity buzzer melody · Excellent alarm function · Suitable for panel installation · Low Power consumption | <ul style="list-style-type: none"> · Compact, light weight, high capacity tones · Low Power consumption and long life expectancy · Simple installation structure with the panel installation type | <ul style="list-style-type: none"> · Compact, lightweight, with 3 melodies · Front LED illuminates during buzzer operation · Simple installation structure with the panel installation type · Low Power consumption |
| Rated voltage | 110 V a.c. 50/60 Hz, 220 V a.c. 50/60 Hz, 12 V d.c., 24 V d.c. | 110 V a.c. 50/60Hz, 220 V a.c. 50/60 Hz 12d.c., 24 V d.c., | 100-240 V a.c. 50/60 Hz, 12 V d.c., 24 V d.c. |
| Power consumption | 4 VA, 8 VA, 30 mA | 2.5 W | 0.6 W, 13.5 W |
| Volume (1 m distance) | 85 dB max | 98 dB max | 80 dB max |
| Page | 170 | | |

■ Terminal Blocks

| Type | Assembly Terminal Blocks | | Fixing Type Terminal Blocks |
|--------------------------|---|---|--|
| Model | HYBT-15A2 | HYTM | HYT |
| Appearance |  |  NEW |  NEW |
| Features | <ul style="list-style-type: none"> · DIN rail installation structure · Possible to assemble the terminal block with different capacity to the same fixing plate · Excellent attaching / detaching of terminal at the temporal position | <ul style="list-style-type: none"> · New design (simple and robust image) · Contact protective structure for the terminal block live parts · O-type and Y-type crimp terminal use more convenient with the screw self-up structure · Din Rail one-touch assemblable and detachable structure (using slotted screwdriver during removal) | <ul style="list-style-type: none"> · Several polarities for each current capacity, easy selection · Body made of phenolic resin (60 - 500 A) and ABS flame retardant resin (10 - 30 A) · Because the bolt and plate underwent heat treatment and rust-proof treatment, it has excellent electrical and mechanical characteristics · Standard product of rated current · Simple installation |
| Rated insulation voltage | 600 V | | |
| Rated current | 15A | 15A, 25A, 35A, 60A, 100A | 10A, 20A, 30A, 60A, 100A, 150A, 200A, 300A, 400A, 500A |
| Insulation resistance | Min. 100 MΩ (between each charging part and between each charging part and mounting metal plate) | | |
| Page | 171 | 171 | 173 |

■ Fuse Holders

| Type | Fuse Holders |
|---------------|--|
| Model | HY-F15/HY-F30 |
| Appearance |  |
| Features | <ul style="list-style-type: none"> ● HY-F15 series <ul style="list-style-type: none"> · LED continuous light indication during fuse disconnection / safety cover installation structure · DIN rail and bolt fixing structure / Easy installation by 1P, 2P, 3P individual products ● HY-F30 series <ul style="list-style-type: none"> · Body materials are made of NYLON66 with glass fiber and have excellent electrical insulation, strong against impact and heat · The fuse comes out when replacing it, which provides excellent safety |
| Rated current | 250 V a.c. 15 A, 24 V d.c. 10 A, 600 V a.c. 30 A |
| Remarks | 110-220 V a.c., 12-24 V d.c., 110-600 V a.c. |
| Page | 175 |

■ Cable Connectors

| Type | Cable Connectors |
|------------|--|
| Model | HYC-M1/HYC-M2 |
| Appearance |  |
| Features | <ul style="list-style-type: none"> · Applied as waterproof and spinning-proof when extending the cable from many machine tools · PF 1/2 cover fixing type nut · Nut tightening structure by the seal rubber and stuffing washer |
| Materials | PC (Resin) |
| Remarks | Ø8, Ø11 |
| Page | 175 |

■ Control Boxes

| Type | Control Boxes |
|------------|---|
| Model | HY-25/HY-30 |
| Appearance |  |
| Features | <ul style="list-style-type: none"> · Rolled iron and ivory color enamel painted · Several operating switches attached (Ø20 and Ø30) · Several specifications (1 ~ 6 holes) |
| Materials | Rolled steel |
| Remarks | Ø25, Ø30 |
| Page | 175 |





TEMPERATURE CONTROLLER

VX series



NEW

Specifications

| Model | | VX9 | VX2 | VX7 | VX4 | | |
|---------------------|---|---|---|---|---|-------------------|-----------------|
| Appearance | |  |  |  |  | | |
| W×H×D(mm) | | 96.0 × 96.0 × 63.0 | 48.0 × 96.0 × 63.0 | 72.0 × 72.0 × 63.0 | 48.0 × 48.0 × 63.0 | | |
| Input | Thermocouple | K, J, E, T, R, B, S, L, N, U, W, PLII | | | | | |
| | Reference junction compensation accuracy | ±1.5 °C (within -10 ~ 50 °C) | | | | | |
| | RTD | JPT100, PT100 | | | | | |
| | Allowable line resistance | Each 3 wire within 10 Ω (However, the resistance between the three lines shall be the same.) | | | | | |
| | DC voltage / current | 1 ~ 5 V (4 ~ 20 mA), 5 V (0 ~ 20 mA), 0 ~ 10 V, 0 ~ 50 mV, 0 ~ 100 mV | | | | | |
| Sampling cycle | | 50 ms | | | | | |
| Control output | Relay output | <ul style="list-style-type: none"> Rated switching capacity : 5A 250 V a.c., 5 A 30 V d.c. Max. switching voltage : 250 V a.c., 110 V d.c. Mechanical life : 2 million times (at 180 CPM) Max. switching power : 750 VA, 90 W Max. switching current : 5 A | | | | | |
| | SSR output | 12 V d.c. ± 1 V d.c. pulse voltage (Load resistance min. 600 Ω) | | | | | |
| | SCR output | 4 ~ 20 mA ±0.2 % of FS ±1 digit, Load resistance min. 600 Ω | | | | | |
| Control | Control type | ON/OFF, PID control, 2DOF PID control | | | | | |
| | Output operation | Reverse action, direct action | | | | | |
| Memory | Non-volatile memory life | <ul style="list-style-type: none"> EEPROM unlocked : when setting E2P.L: OFF in G.SET group - EEPROM life: 1 million times write guaranteed, EEPROM lock setting: when setting E2P.L: ON in G.SET group - store in RAM | | | | | |
| Display | Display method | Wide viewing angle LCD | | | | | |
| USB Loader | Communication method | USB 2.0 | | | | | |
| | Protocol | Protocol : PC-LINK | Baudrate : 38400 bps | Start bit : 1 bit | Data bit : 8bit | Parity bit : None | Stop bit : 1bit |
| | Communication distance | Max.5 m | | | | | |
| Option | Auxiliary Output | Relay 1 to 4 points, rated switching capacity : 5A 250 V a.c., 5 A 30 V d.c. | | | | | |
| | DI | 2 or 4 points | | | | | |
| | | <ul style="list-style-type: none"> Enter the junction: ON: 1 KΩ or less, OFF: 100 KΩ or higher Outflow current: approximately 2 mA per input Enter contactless point: ON: 1.5 V max., OFF: 0.1 mA max. Open state voltage: approximately 5 V d.c. | | | | | |
| | Transmission Output | 1 point, 4 to 20 mA ±0.2% of FS ±1 digit, load resistance: not more than 600 Ω | | | | | |
| | Remote input | 1 contact, 4 ~ 20 mA (1 ~ 5 V) | | | | | |
| | Current input | 1 contact or 2 contacts, 0.0 - 50.0 A, CT-70 Current Detector (Salar Sale) | | | | | |
| | RS-485 | Communication method | EIA RS485 standard, 2-wire half-duplex | | | | |
| | | Max. connections | 31 (Address setting 1~99 available) | | | | |
| | | Communication sequence | No sequence | | | | |
| | | Communication distance | Within 1.2 km | | | | |
| Communication speed | | 4800, 9600, 14400, 19200, 38400, 57600 BPS | | | | | |
| Bit | | <ul style="list-style-type: none"> Start bit : 1 bit Data bit : 7 or 8 bit Parity bit : NONE / EVEN / ODD Stop bit : 1 or 2 bit | | | | | |
| Protocol | | PC-LINK STD, PC-LINK WITH SUM, MODBUS-ASCII, MODBUS-RTU | | | | | |
| Response time | Actual response time = handling time + (response time X 25 ms) | | | | | | |
| Power | AC Power-On Voltage | 100-240 V a.c. 50/60 Hz | | | | | |
| | DC Power-On Voltage | 24 V d.c. | | | | | |
| | Voltage fluctuation rate | ±10 % of power voltage | | | | | |
| | Insulation Resistance | Min. 20 MΩ, 500 V d.c. | | | | | |
| | Voltage Resistance | 3,000 V a.c. 50/60 Hz 1 minute (between primary and secondary terminals) | | | | | |
| | AC Voltage-type power consumption | 9.0 VA or less | 8.5 VA or less | 8.5 VA or less | 8.5 VA or less | | |
| | DC Voltage-type power consumption | 3.2 W or less | 2.7 W or less | 2.8 W or less | 2 W or less | | |
| | Ambient temperature & humidity | -10 ~ 50 °C, 35 ~ 85 % RH (without condensation) | | | | | |
| Storage temperature | -25 ~ 65 °C | | | | | | |
| Ambient |  | | | | | | |
| | <ul style="list-style-type: none"> Electrostatic Discharge(ESD) : KN61000-4-2 Conductive RF(CS) : KN61000-4-6 EFT(RS) : KN61000-4-3 SURGE : KN61000-4-5 | | | | | | |
| Weight (g) | IP65 (The front part) | IP65 (The front part) | IP65 (The front part) | IP66 (The front part) | | | |
| | 290 | 202 | 194 | 120 | | | |
| Components | BODY, FIXED BRACKET, RESISTANCE 250 Ω (1%), RUBBER PACKING, HANDLING INSTRUCTIONS | | | | | | |

Suffix code

| Model | Code | | | | | | | | | | Content | | | | |
|------------------------------|--------------------------|--------------------------|--------------------------|--------------------------|--------------------------|--------------------------|--------------------------|--------------------------|--------------------------|--------------------------|----------------------------------|------------------------------------|--|--|--|
| VX | <input type="checkbox"/> | <input type="checkbox"/> | <input type="checkbox"/> | <input type="checkbox"/> | <input type="checkbox"/> | <input type="checkbox"/> | <input type="checkbox"/> | <input type="checkbox"/> | <input type="checkbox"/> | <input type="checkbox"/> | <input type="checkbox"/> | LCD Digital Temperature Controller | | | |
| Size | 2 | | | | | | | | | | 48(W) × 96(H) × 63(D) mm | | | | |
| | 4 | | | | | | | | | | 48(W) × 48(H) × 63(D) mm | | | | |
| | 7 | | | | | | | | | | 72(W) × 72(H) × 63(D) mm | | | | |
| | 9 | | | | | | | | | | 96(W) × 96(H) × 63(D) mm | | | | |
| Sensor | U | | | | | | | | | | Universal input | | | | |
| OUT 1 (Control Output 1) | M | | | | | | | | | | Relay | | | | |
| | S | | | | | | | | | | SSR | | | | |
| | C | | | | | | | | | | SCR | | | | |
| OUT 2 (Control Output 2) | N | | | | | | | | | | None | | | | |
| | M | | | | | | | | | | Relay | | | | |
| Power | A | | | | | | | | | | 100-240 V a.c. 50/60 Hz | | | | |
| | D | | | | | | | | | | 24 V d.c. | | | | |
| Sub output | A1 | | | | | | | | | | Relay 1 (VX4 standard) | | | | |
| | A2 | | | | | | | | | | Relay 2 (VX2, VX7, VX9 standard) | | | | |
| | A3 | | | | | | | | | | Relay 3 (※ *1,*2) | | | | |
| | A4 | | | | | | | | | | Relay 4 (※ *2) | | | | |
| Communication | | | | | | | | | | | None | | | | |
| | C | | | | | | | | | | RS-485 | | | | |
| Retransmission output (RET) | | | | | | | | | | | None | | | | |
| | T | | | | | | | | | | 4 ~ 20 mA | | | | |
| Digital Input (DI) | | | | | | | | | | | None | | | | |
| | D2 | | | | | | | | | | 2 Contacts (DI 1 ~ 2) | | | | |
| | D4 | | | | | | | | | | 4 Contacts (DI 1 ~ 4) | | | | |
| Current Detection Input (CT) | | | | | | | | | | | None | | | | |
| | H1 | | | | | | | | | | CT 1 | | | | |
| | H2 | | | | | | | | | | CT 2 | | | | |
| Remote input (REM) | | | | | | | | | | | None | | | | |
| | R | | | | | | | | | | 4 ~ 20 mA (1 - 5 V) | | | | |

※ *1) You cannot select from VX4. However, if OUT2=M is selected, SUB3 is available depending on the setting of the parameter.
 ※ *2) You can select from VX2, 7, 9 (VX4 is excluded)
 ※ The orderable name configuration of the VX is available in the User's Guide, Catalog, Please refer to our website.
 ※ Separate
 - Current Detector: CT-70
 - USB Loader Cable: NMC-UM210
 - Terminal Protection Cover

| VX2 | VX4 | VX7 | VX9 |
|----------|----------|----------|----------|
| TC2A-COV | TC4A-COV | TC7A-COV | TC9A-COV |

New product

High function

Programmable Temperature Humidity

Thermal shock Test control

Multi-channel

Economy Ignorance For freezer

Indicator

Input Type INP Parameters and Input Sensor Type and Range

● Thermocouple and side temperature resistor

| Classification | kind | Parameter Settings | | Temperature range | | Error |
|----------------|--------|--------------------|---------------|-------------------|-------------|--|
| | | Display | Communication | °C | °F | |
| THERMO COUPLE | K | K0 | 1 | -200 ~ 1370 | -328 ~ 2498 | ±0.2 % of FS ± 1 digit ±0.2 % of FS ± 1 digit 100~200 °C : ±2.0 % of FS ± 1 digit |
| | | K1 | 2 | -100.0 ~ 500.0 | -148 ~ 932 | |
| | J | J0 | 3 | -200 ~ 1200 | -328 ~ 2192 | |
| | | J1 | 4 | -199.9 ~ 900.0 | -328 ~ 1652 | |
| | E | E1 | 5 | -199.9 ~ 900.0 | -328 ~ 1652 | |
| | T | T1 | 6 | -199.9 ~ 400.0 | -328 ~ 752 | |
| | R | R0 | 7 | 0 ~ 1700 | 32 ~ 3092 | |
| | B | B0 | 8 | 100 ~ 1800 | 212 ~ 3272 | |
| | S | S0 | 9 | 0 ~ 1700 | 32 ~ 3092 | |
| | L | L1 | 10 | -199.9 ~ 900.0 | -328 ~ 1652 | |
| | N | N0 | 11 | -200 ~ 1300 | -328 ~ 2372 | |
| | U | U1 | 12 | -199.9 ~ 400.0 | -328 ~ 752 | |
| | W | W0 | 13 | 0 ~ 2300 | 32 ~ 4172 | |
| | PLII | PL0 | 14 | 0 ~ 1300 | 32 ~ 2372 | |
| RTD | JPt100 | JPt0 | 20 | -200 ~ 500 | -328 ~ 932 | ±0.2 % of FS ± 1 digit |
| | | JPt1 | 21 | -199.9 ~ 500.0 | -328 ~ 932 | |
| | Pt100 | Pt0 | 22 | -200 ~ 640 | -328 ~ 1184 | |
| | | Pt1 | 23 | -199.9 ~ 640.0 | -328 ~ 1184 | |

● DC Current and Voltage

| Classification | kind | Parameter Settings | | Range | Error |
|----------------|---------------|--------------------|---------------|--------------|------------------------|
| | | Display | Communication | | |
| Current Input | 4 ~ 20 mA (※) | 1-5 V | 30 | -1999 ~ 9999 | ±0.2 % of FS ± 1 digit |
| | 0 ~ 20 mA (※) | 5 V | 31 | | |
| VDC / mVDC | 1 ~ 5 V | 1-5 V | 30 | | |
| | 0 ~ 5 V | 5 V | 31 | | |
| | 0 ~ 10 V | 10 V | 32 | | |
| | 0 ~ 50 mV | 0.05 V | 33 | | |
| | 0 ~ 100 mV | 0.1 V | 34 | | |

※ If direct current is used, it is recommended to use a 250 Ω (high precision of 0.1%) resistor connected in parallel to the outside of the terminal. The 250 Ω (1%) resistance enclosed in the product is not a precise resistance, so please be aware of the use.

TEMPERATURE CONTROLLER

Connectivity

VX2

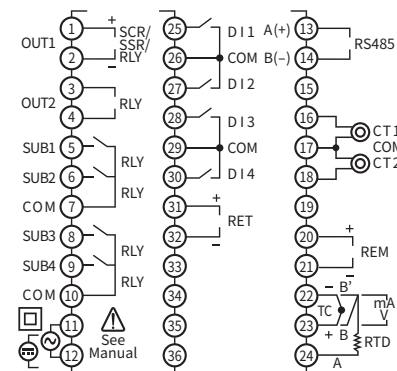

VX4

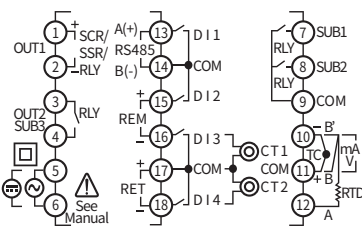

VX7

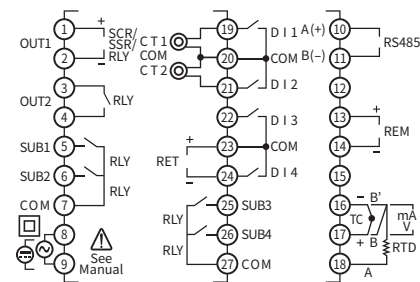

※ Use the following geometry for terminals. ■ Racket Assembly Diagram

[Unit : mm]

VX9

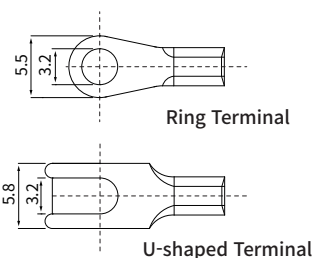
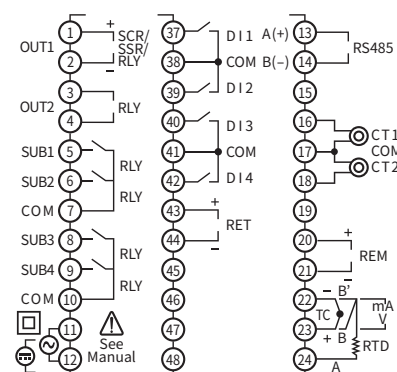

VX4

VX2, VX7, VX9

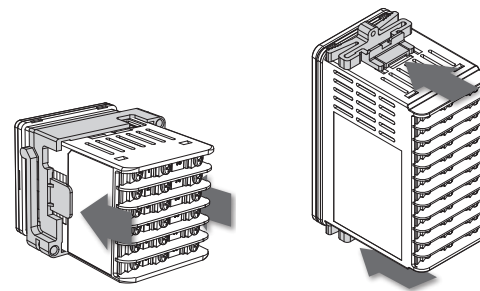

Separate

USB Loader Cable (NMC-UM210, ※Separate)

※ USB2.0 Mini 5PIN Cable

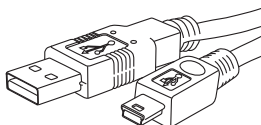

Current Detector (CT-70, ※Separate)

※ HBAEnable in Options
(Current ratio 1000 : 1, Current detection range 0.0 - 50.0 A)

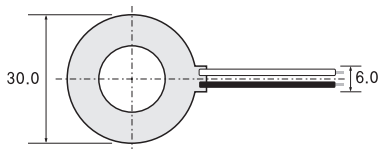

[Unit : mm]

Protective Cover Dimensions (※Separately)

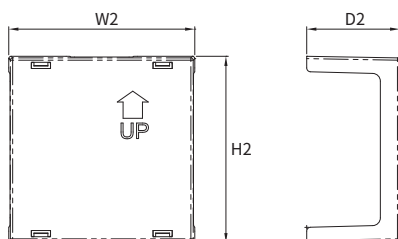

| | | | |
|----------|----------|----------|----------|
| VX2 | VX4 | VX7 | VX9 |
| TC2A-COV | TC4A-COV | TC7A-COV | TC9A-COV |

Appearance dimensions and panel processing dimensions

Product Appearance Dimensions

[Unit : mm]

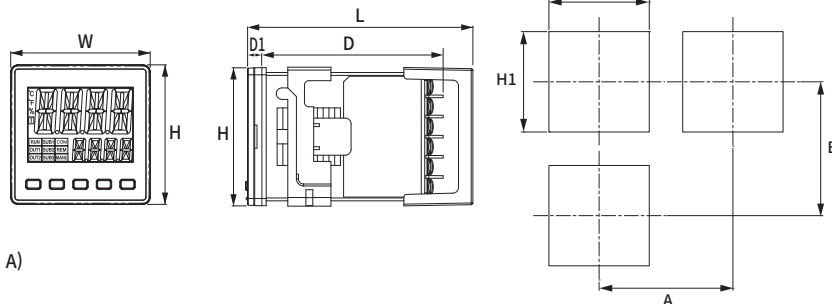





| Sortation | Display | VX2 | VX4 | VX7 | VX9 |
|--------------------|---------|-------|------|-------|-------|
| Product appearance | W | 48.0 | 48.0 | 72.0 | 96.0 |
| | H | 96.0 | 48.0 | 72.0 | 96.0 |
| | D | 63.0 | 63.0 | 63.0 | 63.0 |
| | D1 | 5.5 | 5.0 | 5.5 | 5.5 |
| | L | 78.4 | 78.4 | 78.4 | 78.4 |
| panel processing | W1 *1) | 45.0 | 45.0 | 69.0 | 93.0 |
| | H1 *1) | 93.0 | 45.0 | 69.0 | 93.0 |
| | A | 70.0 | 60.0 | 83.0 | 117.0 |
| | B *2) | 122.0 | 60.0 | 100.0 | 117.0 |
| Protection Cover | W2 | 48.4 | 48.0 | 71.8 | 96.0 |
| | H2 | 94.4 | 48.1 | 71.8 | 96.0 |
| | D2 | 26.9 | 24.0 | 26.9 | 26.9 |

*1) +0.5 mm Apply Tolerance

*2) Apply 100.0 mm when using USB loader cable on VX4

AX series

Specifications

| Model | | AX9 | AX2 | AX7 | AX3 | AX4 |
|--------------------------------|----------------------|---|--|--|---|---|
| Appearance | |  |  |  |  |  |
| W×H×D(mm) | | 96.0×96.0×63.0 | 48.0×96.0×63.0 | 72.0×72.0×63.0 | 96.0×48.0×63.0 | 48.0×48.0×63.0 |
| Input type | | Multi input (Selection by internal parameters), (RTD :Pt 100 Ω, IEC 751) | | | | |
| Sampling cycle | | 100 ms | | | | |
| Input impedance | | Max. 1 MΩ | | | | |
| Allowable input voltage | | 10Vd.c. max | | | | |
| Accuracy | | ±0.3 % of FS ±1 digit (in case of R type, ±1.0 % of FS ± 1 digit in the 0 ~ 600 °C range) | | | | |
| Display | | 7 Segment LED (PV : Red, SV : green) | | | | |
| Front size (mm) | PV | 22.5×11.2 | 14.5×7.0 | 14.5×7.0 | 15.9×7.6 | 13.0×6.5 |
| | SV | 18.7×9.3 | 10.8×5.2 | 9.4×4.7 | 12.0×6.0 | 9.2×5.2 |
| Insulation Resistance | | Min. 20 MΩ, 500 V d.c for 1 min (between 1st and 2nd terminal) | | | | |
| Dielectric strength | | 2300 V a.c. 50/60 Hz for 1 min (between 1st and 2nd terminal) | | | | |
| Control type | | PID control (PID control by auto-tuning), ON/OFF control, P control | | | | |
| Control output operation | | Direct action / reverse action (selection by parameter setting) | | | | |
| Control output type | Relay output (RLY 1) | | 1 A contact, 3 A 240 V a.c. 3 A 30 V d.c. (resistive load) But the relay control output can be set as alarm output when not in use. | | | |
| | Voltage output (SSR) | Time-division proportional control (CYC) | 12 - 15 V d.c. pulse voltage (load resistance min. 600 Ω) | | | |
| | | Phase control (PHA) | | | | |
| | Current output (SCR) | | 4 - 20 mA d.c. (load resistance max. 600 Ω) | | | |
| Power voltage | | 100 - 240 V a.c. 50/60 Hz (10 % of power voltage) | | | | |
| Voltage fluctuation rate | | ±10% of power voltage | | | | |
| Power consumption | | Max. 5.5 VA | | | | |
| Ambient temperature & humidity | | - 5 ~ 50 °C, 35 ~ 85 % RH (Without condensation) | | | | |
| Weight (g) | | 400 | 320 | 300 | 320 | 180 |

New product

High function

Programmable Temperature Humidity

Thermal shock Test control

Multi-channel

Economy Ignorance For freezer

Indicator

Suffix code

| Model | Code | Content |
|------------|--|--|
| AX | <input type="checkbox"/> - <input type="checkbox"/> <input type="checkbox"/> | Multi Input Digital Temperature Controller |
| Appearance | 2 | 48(W) X 96(H) mm |
| | 3 | 96(W) X 48(H) mm |
| | 4 | 48(W) X 48(H) mm |
| | 7 | 72(W) X 72(H) mm |
| | 9 | 96(W) X 96(H) mm |
| Option | 1 | Relay 1 + Relay 2+SSR |
| | 2 | Relay 1 + Relay 2 + Relay 3 + SSR |
| | 1B | SSR + Relay 1(form C) + Relay 2 |
| | 2B | SSR + Relay 1(form C) + Relay 2 + Relay 3 |
| | 3 | 4 - 20 mA + Relay 2 |
| | 4 | 4 - 20 mA + Relay 2 + Relay 3 |
| Power | A | 100-240 V a.c. 50/60 Hz |

※ The relay output operates as control output, alarm output and LBA output depending on the internal parameter settings.







Range and Input Type

| Sortation | Symbol | Input | Range | |
|-----------|----------------|---------|----------------|----------------|
| | | | °C | °F |
| TC | $\mathcal{K}1$ | K | - 100 ~ 1200 | -148 ~ 2192 |
| | $\mathcal{K}2$ | | -100.0 ~ 500.0 | -148 ~ 932 |
| | \mathcal{J} | J | -100.0 ~ 500.0 | -148 ~ 932 |
| | \mathcal{R} | R | 0 ~ 1700 | 32 ~ 3092 |
| | \mathcal{T} | T | -100.0 ~ 400.0 | -148 ~ 752 |
| RTD | \mathcal{Pt} | Pt100 Ω | -100.0 ~ 400.0 | -148.0 ~ 752.0 |

TEMPERATURE CONTROLLER

NX series

Specifications

| Model | | NX9 | NX2 | NX7 | NX3 | NX4 | NX1 |
|---|--|---|---|---|--|---|---|
| Appearance | |  |  |  |  |  |  |
| W×H×D(mm) | | 96.0×96.0×100.0 | 48.0×96.0×100.0 | 72.0×72.0×100.0 | 96.0×48.0×100.0 | 48.0×48.0×100.0 | 48.0×24.0×100.0 |
| Input | Thermocouple input | K, J, E, T, R, B, S, L, N, U, W, PL2 | | | | | |
| | RTD input | Pt 100Ω, KPt 100Ω | | | | | |
| | DC voltage input | 1-5 V d.c., -10-20 mV d.c., 0-100 mV d.c., 4-20 mA d.c. (Attach 250 Ω external resistor) | | | | | |
| | Input sampling cycle | 250 ms | | | | | |
| | Input display resolution | Basically, below the measuring range decimal point | | | | | |
| | Input impedance | · Thermocouple and DC voltage input (mV): min. 1 MΩ, · DC voltage input (V): approx. 1 MΩ | | | | | |
| | Allowable signal source resistance | · Thermocouple : max. 250 Ω · DC voltage : max. 2 kΩ | | | | | |
| | Lead wire allowable resistance | RTD (max. 10 Ω. but the resistance among 3 lines should be same) | | | | | |
| | Allowable input voltage | Within ±10 V (thermocouple, RTD, DC voltage (mV)), within ±20 V (DC voltage (V)) | | | | | |
| | Scaling | -1999 ~ 9999 (SL-L ~ SL-H Range) | | | | | |
| | Input correction | -100.0 % ~ 100.0 % of FS | | | | | |
| | Reference contact compensation error | ±1.5 °C (15 ~ 35 °C Range), ±2.0 °C (0 ~ 50 °C Range) | | | | | |
| Input disconnection detection | · Thermocouple: Select OFF, UP/DOWN Scale · Side temperature resistance: UP Scale (Current detected during thermocouple and side temperature resistance BURN-OUT: about 50 nA) ±0.5 % of FS ±1 Digit, thermocouple (K, J, E, T, R, B, S, L, U, W, PL2) | | | | | | |
| Performance | Display accuracy | ±1.0 % of FS ±1 Digit, thermocouple (N) ±0.5 % of FS ±1 Digit, RTD (KPt100 Ω, Pt100 Ω), DC voltage | | | | | |
| | External power supply | 12 V d.c., 20 mA max. (Cannot be used when using retransmission output) | | | | | |
| | Insulation Resistance | · 1 Blocker to 2 Blocker: 500 V d.c. 20 MΩ or higher · 1 Blocker to GROUND: 500 V d.c. 20 MΩ or higher · 2 Blocker to GROUND: 500 V d.c. 20 MΩ or higher | | | | | |
| | Dielectric strength | · 1 Blocker to 2 Blocker : 2,300 V a.c. 50/60Hz for a minute · 1 Blocker to GROUND : 2,300 V a.c. 50/60Hz for a minute · 2 Blocker to F and G : 1,500 V a.c. 50/60Hz for a minute | | | | | |
| Communication (Optional) | Communication method | RS-422 (4-wire), RS-485 (2-wire) | | | | | |
| | Protocol | PC Link STB, PC Link with Checksum, MODBUS (RTU), MODBUS (ASCII) | | | | | |
| | Communication speed | 2400, 4800, 9600, 14400, 19200 BPS | | | | | |
| | Max. number of connections | 31 (Address setting 1 ~ 99) | | | | | |
| | Communication distance | Max. 1.2 km (total length) | | | | | |
| Control functions and output | Control method | PID auto-tuning | | | | | |
| | Control operation | a) reverse operation (heating) / forward operation (cooling) arbitrary selection (by parameter setting) b) simultaneous heating / cooling control | | | | | |
| | Setting Range | Refer to range and input code | | | | | |
| | Contact input (DI) | Select among 3 preset temperatures with external contact | | | | | |
| | Auto-tuning 2 types | Select target value / low target value auto-tuning | | | | | |
| | Proportional band | 0.1 ~ 999.9 % (Heating / Cooling type : 0.0 ~ 999.9 %) | | | | | |
| | Integral time | OFF, 1 ~ 6,000 sec | | | | | |
| | Differential time | OFF, 1 ~ 6,000 sec | | | | | |
| | ARW(Anti Reset Wind-up) | Auto, 50.0 ~ 200.0 % (Proportional band) | | | | | |
| | ON / OFF control | Select output type by parameter | | | | | |
| | PID selection | Zone PID / Group PID selection | | | | | |
| | Manual reset | Manual reset can be set when Integral time is OFF | | | | | |
| | Output amount at input disconnection (OUT1) | -5.0 ~ 105.0(Normal type), 0.0 ~ 105.0%(Heating / cooling type) | | | | | |
| Output amount at input disconnection (OUT2) | 0.0 ~ 105.0 % | | | | | | |
| Power voltage | 100-240 V a.c. (±10% of power voltage) 24 V a.c. / Vd.c. | | | | | | |
| Power consumption | Up to 6.0 W, 10 VA or less, 8 VA (NX1) | | | | | | |
| Ambient temperature & humidity | 0 ~ 50 °C, 35 ~ 85 % RH (without condensation) | | | | | | |
| Storage temperature | -25 ~ 70 °C | | | | | | |
| Weight(g) | 472 | 342 | 344 | 340 | 342 | 94 | |

Suffix code (NX2, 3, 4, 7, 9)

| Model | Code | Content |
|---------------|---|---|
| NX | <input type="checkbox"/> - <input type="checkbox"/> <input type="checkbox"/> <input type="checkbox"/> | Multi Input/Output Temperature Controller |
| Appearance | 2 | 48(W) X 96(H) mm |
| | 3 | 96(W) X 48(H) mm |
| | 4 | 48(W) X 48(H) mm |
| | 7 | 72(W) X 72(H) mm |
| | 9 | 96(W) X 96(H) mm |
| Control type | 0 | Normal type (heating control) |
| | 1 | Heating / cooling control (simultaneous) |
| | 2 | Heating / cooling control (NX4-20 only) |
| NX9 Option | 0 | - |
| | 1 | RS485, HBA |
| NX7 Option | 0 | - |
| | 1 | RS485, HBA |
| | 2 | SV2, SV3, HBA |
| NX2, 3 Option | 0 | SV2, SV3 |
| | 1 | HBA |
| | 2 | RS485 |
| NX4-0 Option | 0 | - |
| | 1 | HBA, AL2 |
| | 2 | SV2, SV3 |
| | 3 | RET, RS485 |
| | 4 | RS485 |
| | 5 | AL1, AL2 |
| | 6 | AL1, AL2, SV2 |
| 7 | RS485, HBA | |
| NX4-1 Option | 0 | - |
| | 4 | RS485 |
| NX4-2 Option | 0 | AL1 |
| | 4 | AL1 |
| Power voltage | | 100-240 V a.c. 50/60 Hz |
| | D | 24 V d.c. |

New product

High function

Programmable Temperature Humidity

Thermal shock Test control

Multi-channel

Economy Ignorance For freezer

Indicator

Note.
1: OUT1 (terminal ①-②-③) is applied as AL1
However, when selecting control output SSR/SCR6 :
OUT1 (terminal ⑥-⑦) applies as SV2
However, if relay control output

OUT2 (Terminal ⑩-⑪) applies as SSR/SCR

OUT2 (Terminal ⑩-⑪) applies as RLY

Suffix code (NX1)

(Note) NX1-1□ products can select control outputs 6, 9, 10, and 11 outputs.

| Model | Code | Content |
|------------------------|--|--|
| NX1- | <input type="checkbox"/> <input type="checkbox"/> <input type="checkbox"/> | Multi Input/Output Temperature Controller 48(W) X 24(H) mm |
| Control type | 0 | General type |
| | 1 | Heating/cooling control (simultaneous) |
| General type Option | 0 | Option: RET, Terminal number ④, ⑤: RET, Terminal number ⑥, ⑦: OUT1(RLY), Output Selection Initial Value: 3 |
| | 1 | Option: -, Terminal number ④, ⑤: OUT1(SSR/SCR), Terminal number ⑥, ⑦: -, Output Selection Initial Value: 1 |
| | 2 | Option: RS485/RET, Terminal number ④, ⑤: RET, Terminal number ⑥, ⑦: OUT1(RLY), Output Selection Initial Value: 3 |
| | 3 | Option: RS485, Terminal number ④, ⑤: OUT1(SSR/SCR), Terminal number ⑥, ⑦: -, Output Selection Initial Value: 1 |
| | 4 | Option: ALM, Terminal number ④, ⑤: OUT1(SSR/SCR), Terminal number ⑥, ⑦: ALM, Output Selection Initial Value: 1 |
| | 5 | Option: RS485/ALM, Terminal number ④, ⑤: OUT1(SSR/SCR), Terminal number ⑥, ⑦: ALM, Output Selection Initial Value: 1 |
| Heating/Cooling Option | 0 | Option: -, Terminal number ④, ⑤: OUT2(SSR/SCR), Terminal number ⑥, ⑦: OUT1(RLY), Output Selection Initial Value: 6 |
| | 1 | Option: -, Terminal number ④, ⑤: OUT1(SSR/SCR), Terminal number ⑥, ⑦: OUT2(RLY), Output Selection Initial Value: 10 |
| | 2 | Option: RS485, Terminal number ④, ⑤: OUT2(SSR/SCR), Terminal number ⑥, ⑦: OUT1(RLY), Output Selection Initial Value: 6 |
| Power voltage | | 100-240 V a.c. 50/60 Hz |
| | D | 24 V d.c. |

* OUT1 (Heated Output), OUT2 (Cooled Output), RLY (Relay Output), SSR (Voltage Pulse Output), SCR (Current Output, 4-20mAd.c.), RET (Transmission Output)





Range and Input Type

| Model | Code | Input | Range (°C) | Degree | Relative height |
|-------------------------------|------|-----------------|---|--------------------------|---|
| Thermocouple(TC) | 1 | K *2 | -200 ~ 1370 | ±0.5 % of FS ±1 digit | <p>Caution</p> <p>● Measurement Input Wiring</p> <ul style="list-style-type: none"> - Be sure to disconnect the regulator body and external supply when wiring the measurement input lines. There is a risk of electric shock. - Please connect carefully to the polarity of the input. If you connect it incorrectly, it causes the cause of the main body failure. - Please use SHIELD processed wiring for the input. Also, please ground SHIELD with 1 point. - Route the measurement input signal between the power circuit and the ground circuit if possible. - The FS shall be measured from the minimum to the maximum of each range measurable range. - Digit is the minimum display <p>*1) 0 ~ 400 °C Range: ±10 % of FS ±1 digit *2) Below 0 °C: ±1.0 % of FS ±1 digit *3) 20 →kPt100 Ω (C1603) 21, 22 →Pt100 Ω(IEC751) *4) When using current input, select code number "30" and attach a 250 Ohm 0.1% resistance to the input signal terminal.</p> |
| | 2 | K *2 | -199.9 ~ 999.9 | | |
| | 3 | J *2 | -199.9 ~ 999.9 | | |
| | 4 | E *2 | -199.9 ~ 999.9 | | |
| | 5 | T *2 | -199.9 ~ 400.0 | | |
| | 6 | R | 0 ~ 1700 | | |
| | 7 | B *1 | 0 ~ 1800 | | |
| | 8 | S | 0 ~ 1700 | | |
| | 9 | L *2 | -199.9 ~ 900.0 | | |
| | 10 | N | -200 ~ 1300 | ±1.0 % of FS ±1 digit | |
| | 11 | U *2 | -199.9 ~ 400.0 | ±0.5 % of FS ±1 digit | |
| | 12 | W | 0 ~ 2300 | | |
| | 13 | Platinel II | 0 ~ 1390 | | |
| Temperature resistance (RTD) | 20 | KSPT100 Ω *3 | -199.9 ~ 500.0 | ±0.5 % of FS ±1 digit | |
| | 21 | Pt100 Ω *3 | -199.9 ~ 640.0 | | |
| | 22 | Pt100 Ω *3 | -200 ~ 640 | | |
| DC Voltage (V d.c. / mV d.c.) | 30 | 1-5 V d.c. | -1999 ~ 9999 (Using scaling functions (SL-H/SL-L)) | ±0.5 % of FS ±1 digit | |
| | 31 | 0-10 V d.c. | | | |
| | 32 | -10-20 mV d.c. | | | |
| | 33 | 0-100 mV d.c. | | | |
| DC Current | 30 | 4-20 mA d.c. *4 | | | |

TEMPERATURE CONTROLLER

DX series

Specifications

| Model | | DX9 | DX2 | DX7 | DX3 | DX4 |
|--------------------------------|---|--|---|--|---|---|
| Appearance | |  |  |  |  |  |
| W×H×D (mm) | | 96.0×96.0×100.0 | 48.0×96.0×100.0 | 72.0×72.0×100.0 | 96.0×48.0×100.0 | 48.0×48.0×100.0 |
| Input | Thermocouple input | K, J, R | | | | |
| | RTD input | Pt 100 Ω | | | | |
| | DC voltage input | 1-5 V d.c., 0-10 V d.c., 4-20 mA d.c. | | | | |
| | Input sampling cycle | 250 ms | | | | |
| | Input display resolution | Basically 1 °C max. (0.1 °C max. on decimal point range) | | | | |
| | Input impedance | Thermocouple and DC voltage input (mV) : min. 1 MΩ. DC voltage input (V) : approx. 1 MΩ | | | | |
| | Allowable signal source resistance | Thermocouple max. 250 Ω, DC voltage max. 2 kΩ | | | | |
| | Lead wire allowable resistance | RTD max. 10 Ω. (but the resistance among 3 lines should be same) | | | | |
| | Allowable input voltage | ±20 V d.c. for 1 min | | | | |
| | Input correction | ±100 % of FS | | | | |
| | Input scaling | -1999 ~ 9999 (Within SL12 ~ SL13 range, with voltage/current input) | | | | |
| | Reference contact compensation error | ±3.5 °C (0 ~ 50 °C range) | | | | |
| Input disconnection detection | UP Scale | | | | | |
| Performance | Display accuracy | ±0.5 % of FS but ± 1% of FS with voltage input | | | | |
| | Retransm. output accuracy | ±0.2mA d.c. (Load resistance max. 600 Ω, output range 3.2 ~ 20.8 mA d.c.) | | | | |
| | Insulation voltage | Min. 20 MΩ (500 V d.c.) between input terminal and power terminal, between power terminal and protective earth terminal (enclosure) | | | | |
| | Dielectric strength | 2300 V a.c. 50/60 Hz for 1 min (between input terminal and power terminal, between power terminal and protective earth terminal) | | | | |
| Control functions and output | Control type | PID Auto-tuning | | | | |
| | Control operation | Reverse action (heating) or direct action (cooling), by internal setting (SL9) | | | | |
| | Setting range | Same as input range chart | | | | |
| | Proportional band | 0 ~ 100 % of FS | | | | |
| | Integral time | 0 ~ 3,600 sec | | | | |
| | Derivative time | 0 ~ 3,600 sec | | | | |
| | ARW(Anti Reset Wind-up) | Auto(A=0), 0 ~ 100 % of FS | | | | |
| | ON/OFF control | Setting Proportional band to "0" turns ON/OFF control | | | | |
| | During ON/OFF control hysteresis | 0~10 % of FS | | | | |
| | Control loop break alarm (LBA) | 1 ~ 7,200 sec (Generally, 2 times the integral time) | | | | |
| | Proportional period | 1 ~ 100 sec. | | | | |
| | Decimal point position | 1 ~ 4 ("2" When setting 000.0) | | | | |
| | Retransmission output | 4-20 mA d.c. (Measured value) | | | | |
| | Alarm type | High alarm(ALH), low alarm(ALL), high/low within range alarm (deviation setting, absolute setting) | | | | |
| | Output | Relay output | Contact capacity : 1c, 250 V a.c. 5 A (resistive load) | | | |
| Voltage output (SSR) | | Approx. min. 12 V d.c. (load resistance min. 600 Ω) | | | | |
| Current | | 4 - 20 mA d.c. (load resistance max. 600 Ω). Accuracy: ±0.2 mA | | | | |
| Temperature alarm (Relay) | | <ul style="list-style-type: none"> ● DX4Alarm output (ALM): high, low alarm, LBA common, 1 a X 1 contact ● High alarm (ALH) : 1 C X 1 contact (but DX7: 1 a X 1 contact) ● Low alarm (ALL) : 1 a X 1 contact 250 V a.c. 5A (resistive load) | | | | |
| LBA (Relay) | | | | | | |
| Current output | | 4 - 20 mA d.c. (load resistance max. 600 Ω), accuracy: ±0.2 mA. | | | | |
| Power voltage | 100-240 V a.c. 50/60 Hz, 24 V d.c. (Selection by Suffix code) | | | | | |
| Voltage fluctuation rate | ±10 % of power voltage | | | | | |
| Power consumption | 12 VA (100-240 V a.c., 24 V a.c.), 4.5 W (24 V d.c.) | | | | | |
| Ambient temperature & humidity | 0 ~ 50 °C, 35 ~ 85 % RH (Without condensation) | | | | | |
| Storage temperature | -25 ~ 65 °C | | | | | |
| Vibration resistance | 10-55 Hz, 0.76 mm, X, Y, Z each direction 2 hours | | | | | |
| Shock resistance | 300 m/s ² 6 directions each 3 times | | | | | |
| Weight (g) | 472 | 342 | 344 | 340 | 342 | |

Suffix code

| Model | Code | Content |
|--|--|--|
| DX | <input type="checkbox"/> - <input type="checkbox"/> <input type="checkbox"/> <input type="checkbox"/> <input type="checkbox"/> <input type="checkbox"/> <input type="checkbox"/> <input type="checkbox"/> <input type="checkbox"/> | Digital Temperature Controller |
| Appearance | 2 | 48(W) x 96(H) mm |
| | 3 | 96(W) x 48(H) mm |
| | 4 | 48(W) x 48(H) mm |
| | 7 | 72(W) x 72(H) mm |
| | 9 | 96(W) x 96(H) mm |
| Input | K | K thermocouple |
| | J | J thermocouple |
| | R | R thermocouple |
| | P | RTD (Pt 100 Ω) |
| | V | 1-5 V d.c. |
| | C | 4-20 mA d.c. |
| | F | 0-10 V d.c. |
| Control output | M | Relay contact output |
| | C | Current output (4-20 mA d.c.) |
| | S | SSR (Voltage pulse output, 12 V d.c.) |
| Alarm output | S | Alarm output 1 contact (Model : DX4) |
| | W | Alarm output 2 contacts (all models except DX4) |
| Option | A | Retransmission output (4-20mA d.c. measured value) |
| | N | None (DX4, DX7 No retransmission output) |
| Control operation ※ Selection by SL9 (initial value: R) | R | Reverse action (heating control) |
| | D | Direct action (except cooling) |
| Power voltage | | No display (100-240 V a.c.) |
| | C | 24 V a.c. 50/60 Hz or 24 V d.c. |

| |
|-----------------------------------|
| New product |
| High function |
| Programmable Temperature Humidity |
| Thermal shock Test control |
| Multi-channel |
| Economy Ignorance For freezer |
| Indicator |







Range and input code chart

| Classification | Code | Input | Range (°C) | | Accuracy |
|----------------------|------|--------------|------------------|----------------------|--------------|
| | | | 1°C (SL2 : X1XX) | 0.1°C (SL2 : X0XX) | |
| Thermocouple (TC) | 0001 | K | -50 ~ 1,300 | -50.0 ~ 999.9 | ±0.5 % of FS |
| | 0101 | J | -50 ~ 600 | -50.0 ~ 600.0 | |
| | 0100 | R | 0 ~ 1700 | 0.0 ~ 999.9 | |
| RTD | 0011 | Pt100 Ω | -199 ~ 640 | -199.0 ~ 640.0 | |
| Voltage/Current | 0000 | 1-5 V d.c. | -1999 ~ 9999 | Decimal point by SL4 | 1 % of FS |
| | 0000 | 4-20 mA d.c. | -1999 ~ 9999 | | |
| | 1111 | 0-10 V d.c. | -1999 ~ 9999 | | |

TEMPERATURE CONTROLLER

KX series

Specifications

| Model | | KX9N | KX2N | KX7N | KX3N | KX4N | KX4S |
|--------------------------------|--|---|---|---|--|---|---|
| 외형 | |  |  |  |  |  |  |
| W×H×D(mm) | | 96.0×96.0×100.0 | 48.0×96.0×100.0 | 72.0×72.0×100.0 | 96.0×48.0×100.0 | 48.0×48.0×100.0 | 48.0×48.0×87.0 |
| Input | Thermocouple input | K, J, E, T, R, B, S, L, N, U, W, PL2 | | | | | |
| | RTD input | Pt 100 Ω, KPt 100 Ω | | | | | |
| | DC voltage input | 1-5 V d.c. (4-20 mA d.c.), 0-10 V d.c. | | | | | |
| | Input display resolution | Basically, below the range decimal point | | | | | |
| | Input sampling cycle | 250 ms | | | | | |
| | Allowable signal source resistance | Max. 250 Ω (Thermocouple input), max. 2 kΩ (DC voltage input) | | | | | |
| | Lead wire allowable resistance | RTD : max. 10 Ω/1 wire. The resistance between 3 lines should be same | | | | | |
| | Allowable input voltage | ±20 V d.c. for 1 min | | | | | |
| | Scaling | 0.0 % ~ 100.0 % of FS | | | | | |
| | Reference contact compensation error | ±3.5 °C (0 ~ 50 °C range) | | | | | |
| Input disconnection function | Up-scale and output OFF when input is disconnected | | | | | | |
| Performance | Display accuracy | ± 0.5 % of FS (but, 0 ~ 400 °C range of B thermocouple is out of guarantee range). Refer to "range and input code chart" | | | | | |
| | Insulation Resistance | Min. 20 MΩ, 500 V d.c., for 1 min (between 1st and 2nd terminal) | | | | | |
| | Dielectric strength | 2300 V a.c. 50/60 Hz for 1 min (between 1st and 2nd terminal) | | | | | |
| Control functions and output | Setting range | Refer to "Range and input code chart" | | | | | |
| | Control type | PID control, ON/OFF control | | | | | |
| | Proportional band (P) | Within input range | | | | | |
| | Integral time | 0 ~ 3600 sec. | | | | | |
| | Derivative time | 0 ~ 3600 sec. | | | | | |
| | ARW (Anti Reset Wind-up) | Within input range | | | | | |
| | Control loop break alarm (LBA) | 0 ~ 7200 sec. | | | | | |
| | Proportional period | 0 ~ 100 sec. | | | | | |
| | Control output hysteresis | 0 ~ 10 % of FS | | | | | |
| | ON/OFF control | Set the Proportional band to "0" (0.0) | | | | | |
| | Alarm type | Absolute alarm, deviation alarm (high alarm, low alarm, within range alarm) | | | | | |
| | Range over display | When exceed max. range "0000", when exceed min range "UUUU" flashing | | | | | |
| | Decimal point function | Decimal point position selection by parameter during DC voltage input | | | | | |
| | Decimal point position selection | Decimal point selection during current input and DC voltage (0~3 position) | | | | | |
| | Input correction value setting | -100.0 ~ 100.0 of FS | | | | | |
| | High or low alarm hysteresis | 0 ~ 10 % of FS | | | | | |
| | High / Low range Limit | Within input range | | | | | |
| Output operation | Direct / reverse action selectable by setting | | | | | | |
| Scale setting | -199 ~ 9999 (High and low scale setting during DC voltage input) | | | | | | |
| Control output | Relay output | ● NO : 5 A 250 V a.c., 5 A 30 V d.c. (Resistive load) ● NC : 3 A 250 V a.c., 1 A 30 V d.c. (Resistive load) | | | | | |
| | Voltage output (SSR) | Min. 12 V d.c., pulse voltage (load resistance min. 600 Ω) | | | | | |
| | Current output (SCR) | 4-20 mA d.c. (Load resistance min. 600 Ω), Accuracy : ±0.2 mA | | | | | |
| Alarm output | Relay output | 250 V a.c. 3 A (load resistance) ※ refer to connection diagram(contact), but KX4N: 1A contact, 250 V a.c. 1 A (load resistance) | | | | | |
| Retransm. output | Current output | 4-20 mA d.c. (Load resistance max. 600 Ω), Accuracy: ±0.2 mA | | | | | |
| Power voltage | | 100-240 V a.c. 50/60 Hz, 24 V d.c. (KX4S 제외) | | | | | |
| Voltage fluctuation rate | | ±10 % of power voltage | | | | | |
| Power consumption | | 11 VA max. | | | | 7 VA max. | |
| Ambient temperature & humidity | | 0 ~ 50 °C, 35 ~ 85 % RH (Without condensation) | | | | | |
| Weight (packed) | | 400 | 320 | 300 | 320 | 180 | |

Suffix code

| Model | Code | Content | |
|----------------------------------|--------------|--|--|
| KX | □- □ □ □ □ □ | Digital Temperature Controller (Multi Input) | |
| Dimensions | 2N | 48(W) X 96(H) mm | |
| | 3N | 96(W) X 48(H) mm | |
| | 4N | 48(W) X 48(H) mm | |
| | 7N | 72(W) X 72(H) mm | |
| | 9N | 96(W) X 96(H) mm | |
| | 4S | 48(W) X 48(H) mm | For 11 pin sockets (2-stage step function by external contact) |
| Control output | M | Relay | |
| | S | SSR (Voltage pulse 12 V d.c.) | |
| | C | SCR (Current 4-20mA d.c.) | |
| Alarm output | C | ※ KX4N, KX4S only | ALH, ALL, LBA (1a common output) |
| | | ※ KX4S Not selectable | |
| | E | KX2N, KX3N, KX9N | ALH(1c),ALL(1a) |
| | | KX7N, KX4N (Optional) | ALH(1a),ALL(1a) |
| | K | ※ KX4N, KX4S Not selectable | |
| | | KX2N, KX3N, KX9N (Optional) | ALH(1c),ALL(1a),LBA(1a) |
| KX7N (Optional) | | ALH(1a),ALL(1a),LBA(1a) | |
| Retransmission output (optional) | A | ※ Selectable only in the following models KX4N-□C KX2N-□E, KX3N-□E, KX9N-□E KX2N-□K, KX3N-□K, KX9N-□K | Retransmission output (RET) 4-20 mA d.c. |
| | N | None | |
| Power voltage | A | 100-240 V a.c. 50/60 Hz | |
| | D | 24 V d.c. (But KX4S excluded) | |

| |
|-----------------------------------|
| New product |
| High function |
| Programmable Temperature Humidity |
| Thermal shock Test control |
| Multi-channel |
| Economy Ignorance For freezer |
| Indicator |

* When using 4 - 20 mA input, please attach 250 Ω 0.1% resistor to 1 - 5 V d.c input terminal

Range and Input Type

| Classification | Code(SL1) | Input type | Range (°C) | | |
|--------------------|-----------|--------------------|-------------------|---------------------|------------------------------|
| | | | 1 °C (SL2 : X1XX) | 0.1 °C (SL2 : X0XX) | |
| Thermocouple(TC) | 0001 | K | - 50 ~ 1300 | - 50.0 ~ 999.9 | |
| | 0101 | J | * 2 | - 50 ~ 600 | - 50.0 ~ 600.0 |
| | 1100 | E | | - 199 ~ 999 | - 199.9 ~ 999.9 |
| | 1101 | T | | - 50 ~ 400 | - 50 ~ 400.0 |
| | 0100 | R | | 0 ~ 1700 | 0.0 ~ 999.9 |
| | 0110 | B | * 1 | 0 ~ 1800 | 0.0 ~ 999.9 |
| | 0111 | S | | 0 ~ 1700 | 0.0 ~ 999.9 |
| | 1000 | L | * 2 | - 199 ~ 900 | - 199.9 ~ 900.0 |
| | 1001 | N | * 2 | - 199 ~ 1300 | - 199.9 ~ 999.9 |
| | 1010 | U | | - 199 ~ 400 | - 199.9 ~ 400.0 |
| | 1011 | W(Re5-Re25) | | 0 ~ 2300 | 0.0 ~ 999.9 |
| RTD | 0010 | KPt100 Ω(Old type) | | - 199 ~ 500 | - 199.9 ~ 500.0 |
| | 0011 | Pt100 Ω(IEC) | | - 199 ~ 640 | - 199.9 ~ 640.0 |
| DC Voltage(V d.c.) | 0000 | 1-5 V d.c. | * 3 | - 199 ~ 9999 | Select Decimal Points by SL4 |
| | 1111 | 0-10 V d.c. | * 3 | | |

※ K, J, E, T, R, B, S, N : IEC 584. L, U : DIN 43710, W(Re5-Re25) : Hoskins Mfg.Co.USA. Pt100 Ω : IEC 751, KS C1603. (Kpt100 Ω : Rt =139.16 Ω

※ Rt : Resistance value at 100°C).

※ 4 - 20 mA When using a current input, attach 250 Ω 0.1% shunt resistance to both ends of the input terminals in 1-5 V d.c. input mode.

※ Degree : ± 0.5 % of FS

* 1) The 0 to 400°C range is outside the warranty range

* 2) ±1% of FS in the range below 0°C

* 3) ± 1 % of FS

TEMPERATURE CONTROLLER

TD510 CE

Specifications

| Model | | TD510 | | |
|--------------------------------|-------------------------------|---|---|--|
| Appearance | |  | | |
| W×H×D (mm) | | 145.0×145.0×33.5 | | |
| Power voltage | | 100-240 V a.c. 50/60 Hz (Voltage fluctuation rate: ±10 % of power voltage) 30 V A max | | |
| Dielectric strength | | <ul style="list-style-type: none"> ● Between 1st and 2nd terminals: Min. 1500 V a.c for 1 min ● Between 2nd and FG terminals: Min. 1500 V a.c for 1 min ● between 1st and FG terminals: Min. 1500 V a.c for 1 min | | |
| Input type | | <ul style="list-style-type: none"> ● 2 types of RTD (Pt-100, KPt-100) ±0.1 % of FS ±1 Digit ● 11 types of thermocouple (K, J, E, T, R, B, S, L, N, U, Wire 5 - 26) ±0.15 % of FS ±1 Digit ● 4 types of DC voltage (-10 - 20 mV, 0 - 100 mV, 1 - 5 V, 0 - 30 V) ±0.1 % of FS ±1 Digit | | |
| Sampling cycle | | 250 ms | | |
| Contact output (DO) | Up to 32 relay contacts | A contact | 30 V d.c. 3 A max, 250 V a.c. 3 A | |
| | | B contact | NO : 30 V d.c. 5 A max, 250 V a.c. 5 A | |
| Control output | SSR output | ON : 18 V d.c. Pulse voltage (Load resistance min. 800 Ω) | | |
| | SCR output | 4-20 mA d.c. (Load resistance max. 600 Ω) | | |
| Retransmission output | Current output | 4-20 mA d.c. | | |
| | Load resistance | Load resistance max. 600 Ω | | |
| | Output type | Present value (PV), Set value (SV), output volume (MV), Random selection | | |
| | Refresh interval | 250 ms | | |
| Functions | Input type | Input calibration (sensor bias) | Temperature 2 contacts : EUS(0 ~ 100 %) | |
| | | Scaling | DC voltage (VDC): Input scaling according to conversion range | |
| | | Input filter(LPF) | 0 ~ 120 sec | |
| | Control mode | Operation type | Constant-value / Program control | |
| | Control output | Temperature control output | SSR or SCR (4 - 20 mA d.c.) output selection | |
| | | Pattern | 100 patterns (1 pattern / 100 segments) | |
| | Control operation | Segment | 2,000 segments | |
| | | PID group | 4 groups | |
| | | Auto-tuning | Auto-tuning according to target set value | |
| | | Proportional band | 0.00 ~ 100.00 % (ON / OFF control for 0.00%) | |
| | | Integral time | 0 ~ 3,000 seconds (OFF state if 0 second is set) | |
| | | Derivative time | | |
| ON/OFF control | | Set proportional band (PB) to 0 | | |
| Direct/reverse action | | Depending on the direct/reverse action selection of the control output | | |
| Retransmission output | Hysteresis | EUS (0 ~ 100 %) | | |
| | Temperature (Ch.1 and 2) | 4 - 20 mA d.c. Present value (PV), Set value (SV), output volume (MV) | | |
| | Scaling | Auto scaling for defined upper/lower, limit range (4 - 20 mA d.c.) | | |
| Alarm setting | Setting alarm | System alarm: 8 contacts. Assign 4 of 8 pattern alarms to a pattern | | |
| | Alarm type | High/Low absolute, High/Low deviation, Within/Out of range (alarm direction, hold) | | |
| | Absolute alarm setting range | EU (0 ~ 100 %) | | |
| | Deviation alarm setting range | EUS (-100 ~ 100 %) | | |
| | Hysteresis | EUS (0 ~ 100 %) | | |
| Display | | TFT Color LCD (115.2 × 86.4 mm) | | |
| Resolution | | 640 × 480 pixel | | |
| Back light | | LED Back light | | |
| Back light life | | Approx. 40,000 h | | |
| Touch type | | Resistive type (4 Wires) | | |
| Language | | Korean/English/Chinese (Simplified) | | |
| Saving functions | Internal memory | Non-volatile memory : 80 MB | | |
| | External memory | SD Card (8 GB) | | |
| | Saving interval | 1 ~ 360 sec | | |
| Memory information | | Program information, set value save, recovery, temperature set / process / output value | | |
| Ambient temperature & humidity | | 0 ~ 50 °C, 20 ~ 90 % RH (Without condensation) | | |
| Weight (g) | | 1,320 | | |

Suffix code

| Model | Code | Content |
|--------------|---|--|
| TD51 | <input type="checkbox"/> <input type="checkbox"/> <input type="checkbox"/> <input type="checkbox"/> | Programmable Temperature Controller |
| Channels | 0 | 2 Channel |
| | 1 | 1 Channel |
| Display part | 1 | 5.7" TFT-LCD |
| | N | None |
| Input/output | 1 | 8 input contacts · 6 output contacts (1 module) |
| | 2 | 8 input contacts · 14 output contacts (2 modules) |
| | 3 | 16 input contacts · 16 output contacts (3 modules) |
| | N | No input/output |
| Language | S | Korean, English and Chinese (simplified) |
| | T | Korean, English and Chinese (traditional) |

Components

| Product | Model | Content |
|---------------------|------------|---|
| Display part | TD51□-1N□ | Display part (5.7" TFT LCD) |
| Control module | TD510-MAIN | Temperature 2-channel control module |
| | TD511-MAIN | Temperature 1-channel control module |
| Power module | TM-PWR | Power module |
| Input module | TM-DI | Module with 16 input contacts |
| Output module | TM-DO | Module with 8 output contacts |
| Input/output module | TM-DIO | Module with 8 input and 6 output contacts |

※ This product consists of display part / power module / control module / input module / output module (digital input (DI) with up to 32 contacts, digital output (DO) with up to 32 contacts).

TD500 CE

Specifications

| Model | TD500 | |
|--------------------------------|--|---|
| Appearance |  | |
| W×H×D (mm) | 183.0×144.0×102.7 | |
| Power voltage | 100-240 V a.c. 50/60 Hz 16 W max. (Voltage fluctuation rate: ±10 % of power voltage) | |
| Screen | 5.7 "STN-LCD and touch panel interface | |
| Program | Up to 100 patterns, individual pattern operation possible for each channel / Up to 2,400 segments (up to 100 segments per pattern) | |
| Input (2 channels) | Pt100 (IEC751) | -200.0 ~ 640.0 °C, ± 0.1 % of FS |
| | TC_K | -200.0 ~ 1,370.0 °C, ± 0.1 % of FS |
| | TC_J | -200.0 ~ 1,200.0 °C, ± 0.1 % of FS |
| | TC_E | -200.0 ~ 1,000.0 °C, ± 0.1 % of FS |
| | TC_T | -200.0 ~ 400.0 °C, ± 0.1 % of FS |
| | TC_R | 0 ~ 1,700.0 °C, ± 0.1 % of FS |
| | TC_S | 0 ~ 1,700.0 °C, ± 0.1 % of FS |
| | mV | 0 - 100 mV or -10 - 20 mV (-999.9 - 9999.9), ± 0.1 % of FS |
| | VDC | 0 - 10 V (the signal range can be set, -999.9 - 9999.9), ± 0.1 % of FS |
| 4 - 20 mA | 250 Ω using the external resistor, V d.c 1 ~ 5 V using after setting | |
| Sampling cycle | 500 ms | |
| Output | Control output | 2 contacts for each channel (heating/cooling) |
| | Voltage pulse output (SSR) | 24 V d.c. Pulse (load resistance min. 600 Ω), minimum pulse width: 10 ms |
| | Current output (SCR) | 4 - 20 mA d.c. (load resistance max. 600 Ω) |
| | Relay output | <ul style="list-style-type: none"> External relay using built-in relay or Tr output (max. 24 V, 100 mA) Built-in relay specifications: NO → 250 V a.c. 5 A / 30 V d.c. 5 A, NC → 250 V a.c. 2 A / 30 V d.c. 1 A |
| Communication | <ul style="list-style-type: none"> RS485 communication distance: approx. within 1.2 km Max. number of connections: 32 Communication speed: max. 115,200 bps | |
| | RS 232, RS422/485 | |
| Ambient temperature & humidity | 0 ~ 50 °C, 20 ~ 90 % RH (Without condensation) | |
| Weight (g) | Approx. 2.35 kg | |

Suffix code

| Model | Code | Content |
|--------------------|--|--|
| TD500 | <input type="checkbox"/> <input type="checkbox"/> <input type="checkbox"/> | 2-Channel Programmable Temperature Controller |
| Types | N | None (Only when need the input/output board) |
| | 1 | Communication (RS485/422 communication, USB) |
| | 2 | Communication (RS232 communication, USB) |
| Input/output board | N | None (Only when need the standard body) |
| | 1 | Digital input (DI) 8 contacts, Digital output (DO) 8 contacts, Transistor output (DO) 8 contacts |
| Language | N | Korean/English (Standard type). No code indication. |
| | 1 | English/Chinese (simplified) |

| |
|-----------------------------------|
| New product |
| High function |
| Programmable Temperature Humidity |
| Thermal shock Test control |
| Multi-channel |
| Economy Ignorance For freezer |
| Indicator |

TEMPERATURE CONTROLLER

TD300

Specifications

| | | |
|--------------------------------|----------------------------|--|
| Model | | TD300 |
| Appearance | |  |
| W×H×D (mm) | | 96.0×96.0×100.0 |
| Power voltage | | 100-240Va.c. 50/60 Hz Max. 10 W (voltage fluctuation rate: ±10 % of power voltage) |
| Screen | | 3.5" TFT-LCD and touch panel interface |
| Program | | Up to 100 patterns, individual pattern operation possible for each channel / Up to 2,400 segments (up to 100 segments per pattern) |
| Input (2 channels) | Pt100 (IEC751) | -200.0 ~ 640.0 °C, ± 0.1 % of FS |
| | TC_K | -200.0 ~ 1,370.0 °C, ± 0.1 % of FS |
| | TC_J | -200.0 ~ 1,200.0 °C, ± 0.1 % of FS |
| | TC_E | -200.0 ~ 1,000.0 °C, ± 0.1 % of FS |
| | TC_T | -200.0 ~ 400.0 °C, ± 0.1 % of FS |
| | TC_R | 0 ~ 1,700.0 °C, ± 0.1 % of FS |
| | TC_S | 0 ~ 1,700.0 °C, ± 0.1 % of FS |
| | mV | 0 - 100 mV or -10 - 20 mV (-999.9 ~ 9999.9), ± 0.1 % of FS |
| | VDC | 0 - 10 V (The signal range can be set, -999.9 ~ 9999.9), ± 0.1 % of FS |
| | 4 - 20 mA | 4 - 20 mA : 250 Ω using the external resistor, V d.c. 1 ~ 5 V using after setting |
| Sampling cycle | | 500 ms |
| Output | Control output | 2 contacts for each channel (heating/cooling) |
| | Voltage pulse output (SSR) | 24 V d.c. Pulse (Load resistance min. 600 Ω), minimum pulse width : 10 ms |
| | Current output (SCR) | 4-20 mA d.c. (Load resistance max. 600 Ω) |
| | Relay output | NO → 250 V a.c. 5 A / 30 V d.c. 5 A |
| Communication | Protocol | PCLINK, Modbus-ASCII |
| | Specifications | ● RS232C : 9600 ~ 38400 bps max. 10 m ● RS422/485 : 9600 ~ 38400 bps max. 1.2 km 256 Mode |
| Ambient temperature & humidity | | 0 ~ 50 °C, 20 ~ 90 % RH (Without condensation) |
| Weight(g) | | 850 |

Suffix code

| Model | Code | Content |
|---------------|---|---|
| TD300 | <input type="checkbox"/> <input type="checkbox"/> | 2-Channel Programmable Temperature Controller |
| Communication | 1 | RS485/422 |
| | 2 | RS232C |
| Language | 1 | Korean/English (standard type) |
| | 2 | English/Chinese (simplified) |

TH500

Specifications

| Model | | TH500 | |
|--------------------------------|--|--|--|
| Appearance | |  | |
| W×H×D (mm) | | 183.0×144.0×93.5 | |
| Program | | 100 patterns (1 pattern / 100 segments) max. 6000 segments | |
| Screen | | Color STN LCD (115.17 X 86.37 mm : 5.7") | |
| Functions | | Pattern repetition: max. 999 times, partial repetition: max. 255 / pattern link and edit | |
| Power voltage | | 100-240 V a.c. 50/60 Hz (Voltage fluctuation rate: ±10 %) | |
| Input | Sampling cycle | 500 ms | |
| | Measuring range | Temperature | -100.00 ~ 200.00 °C |
| | | Humidity | 0.0 ~ 100.0 % RH |
| | Display accuracy | ● Temperature : ±0.1 % of FS ● Humidity : ±1 % of FS | |
| Input type | Pt 100 Ω, 0(1) - 5 V d.c. or 4-20 mA d.c. (External resistance: 250 Ω) | | |
| Output | Control output | SSR output | Min. 24 V d.c. (Minimum pulse width: 0.2 ms) |
| | | Current output | 4-20 mA d.c. |
| | Retransmission output | ● Temperature: 1 contact | |
| | | ● Humidity: 1 contact. Present value (PV), Set value (SV), output volume (MV) Random selection 4 - 20 mA load resistance: max. 600 Ω | |
| Contact input | DI : 8 Contacts | | |
| Output | Max. 20 contacts (relay 12 contacts, open collector 8 contacts or relay 20 contacts) | | |
| Contact output type | | Inner signal : 8 contacts, Alarm signal : 4 contacts each channel, Run/Stop signal : 1 contact, 1st Ref. signal : 1 contact, 2nd Ref. signal : 1 contact Temperature / Humidity Up/Down ● Soak signal: 6 contacts ● Temp./Humi. Control signal: 2 contacts ● Time signal : 8 contacts / 1 segment ● Error signal : 1 point ● Sensor disconnection signal : 1 point ● Wait signal : 1 point ● Hold signal : 1 point ● PT End signal: 1 signal | |
| Communication output | | ● RS485 communication distance: approx. within 1.2 km ● Max. number of connections: 32 ● Communication speed: max. 115,200 bps RS 232, RS422/485 | |
| Storage | | Internal FLASH memory, temperature/Humidity each 86,400 contacts | |
| Storage functions | | Program information, set value save, recovery, temperature & humidity set / present value save | |
| Ambient temperature & humidity | | 0 ~ 50 °C, 10 ~ 90 % RH (Without condensation) | |
| Weight (g) | | 2,350 | |

| |
|-----------------------------------|
| New product |
| High function |
| Programmable Temperature Humidity |
| Thermal shock Test control |
| Multi-channel |
| Economy Ignorance For freezer |
| Indicator |

Suffix code

| Model | Code | Content | |
|-----------------------------|--|--|---|
| TH500- | <input type="checkbox"/> <input type="checkbox"/> <input type="checkbox"/> | Programmable Temperature & Humidity Controller | |
| Types | 1 | Standard type | Temperature & humidity retransmission output Temperature & humidity control output (SSR/SCR drive) Temperature & humidity signal input External digital input (DI): 8 contacts Digital output (DO): relay 12 contacts, open collector 8 contacts Communication specifications: RS232, RS422/485, USB |
| | 2 | Detachable type | ※ Input and output boards are separated from the main body Temperature & humidity retransmission output Temperature & humidity signal input Communication specifications : RS232, RS422/485 2CH, USB (PV Backup) |
| | N | - | No body part |
| Detachable board (optional) | 1 | Input/Output board-1 (12 contacts Relay output), temperature/humidity control output (SSR/SCR drive) DI : 8 contacts, DO : 12 contacts Relay output, external power supply 24 V d.c. 18 W | |
| | 2 | Input/Output board-2 (8 contacts open collector output external terminal board) | |
| | 3 | Input/Output board-3 (8 contacts Relay output board) | |
| | 4 | (Input/Output board-1) + (output board-2) | |
| | 5 | (Input/Output board-1) + (output board-3) | |
| | N | No output board (when select the main body) | |
| Language | N | Korean/English (standard type) | |
| | 2 | English/Chinese (simplified) | |
| | 3 | English/Chinese (traditional) | |

TEMPERATURE CONTROLLER

TH510 CE

Specifications

| Model | | TH510 | |
|--------------------------------|----------------------------------|---|--|
| Appearance | |  | |
| W×H×D (mm) | | 145.0×145.0×33.5 | |
| Power voltage | | 100-240 V a.c. Voltage fluctuation rate ±10 % | |
| Power frequency | | 50/60 Hz | |
| Power consumption | | 30 V A max | |
| Dielectric strength | | <ul style="list-style-type: none"> ● Between 1st and 2nd terminals: Min. 1500 V a.c. for 1 min ● Between 1st and FG terminals: Min. 1500 V a.c. for 1 min ● Between 2nd and FG terminals: Min. 1500 V a.c. for 1 min | |
| Input type | | <ul style="list-style-type: none"> ● 2 types of RTD (Pt-100, KPt-100) ±0.1 % of FS ±1 Digit ● 2 types of DC voltage (1 - 5 V, 0 - 30 V) ±0.1 % of FS ±1 Digit | |
| Sampling cycle | | 250 ms | |
| Contact outputs(DO) | Relay contact max. 32 contacts | A contact | 30 V d.c. 3 A max, 250 V a.c. 3 A |
| | | B contact | NO : 30 V d.c. 5 A max, 250 V a.c. 5 A |
| Control output | SSR output | ON : 18 V d.c. pulse voltage (load resistance min. 800 Ω) | |
| | SCR output | 4-20 mA d.c. (Load resistance max. 600 Ω) | |
| Retransmission output | Current output | 4-20 mA d.c. | |
| | Load resistance | Load resistance max. 600 Ω | |
| | Output type | Present value (PV), Set value (SV), output volume (MV), Random selection | |
| | Refresh interval | 250 ms | |
| Input type | Input calibration (sensor bias) | Temperature 1 contact: EUS (0 ~ 100%) Humidity 1 contact: EUS (0 ~ 100%) | |
| | Dry/wet bulb sensor compensation | Compensate the difference between the wet and dry bulb sensor after removing the wet bulb sensor gauze. | |
| | Scaling | DC voltage (VDC): Input scaling according to conversion range | |
| | Input filter (LPF) | 0 ~ 120 sec | |
| Control mode | Operation type | Constant-value / Program control | |
| Control output | Temperature control output | Output (SSR) or current output (4 - 20 mA d.c.) selection | |
| | Humidity control output | | |
| Functions | Control operation | Pattern | 100 patterns (1 pattern / 100 segments) |
| | | Segment | 2000 Segment |
| | | PID group | 16 groups (temperature 4 zones X humidity 4 zones) |
| | | Auto-tuning | Auto-tuning according to target set value |
| | | Proportional band | 0.00 ~ 100.00 % (for 0.00 %, ON/OFF control) |
| | | Integral time | 0.0 ~ 3000 sec. (OFF status when 0 sec is set) |
| | | Derivative time | |
| Re-transmission output | Temperature, Humidity | Current output (4 - 20 mA d.c.) Present value PV, Set value (SV), output volume (MV) selection | |
| | Scaling | Automatic scaling of set high and low range (4 - 20 mA d.c.) | |
| Alarm setting | Setting alarm | System alarm: 8 contacts Assign 4 of 8 pattern alarms to a pattern | |
| | Alarm type | High/Low absolute, High/Low deviation, Within/Out of range (alarm direction,hold) | |
| | Absolute alarm setting range | EU (0 ~ 100 %) | |
| Display | | TFT color LCD (115.2 × 86.4 mm) | |
| Resolution | | 640 × 480 pixel | |
| Back light | | LED back light | |
| Back light life | | Approx. 40,000 h | |
| Touch type | | Resistive type (4 Wires) | |
| Language | | Korean/English/Chinese (simplified) | |
| Saving functions | Internal memory | Non-volatile memory : 80 MB | |
| | External memory | SD card (8 GB) | |
| | Saving interval | 1 ~ 360 sec | |
| Memory information | | Program information, set value, recovery, temperature set / process / output value | |
| Ambient temperature & humidity | | 0 ~ 50 °C, 20 ~ 90 % RH (without condensation) | |
| Weight (g) | | 1,320 | |

Suffix code

| Model | Code | Content |
|---------------|--|--|
| TH | <input type="checkbox"/> 1 <input type="checkbox"/> 0 - <input type="checkbox"/> <input type="checkbox"/> <input type="checkbox"/> | Programmable Temperature & Humidity Controller |
| Display part | 5 | 5.7" TFT-LCD |
| Input/output | 1 | 8 input contacts.6 output contacts (1 module) |
| | 2 | 8 input contacts.14 output contacts (2 module) |
| | 3 | 16 input contacts.16 output contacts (3 modules) |
| Language | S | Korean, English and Chinese (simplified) |
| | T | Korean, English and Chinese (traditional) |
| Communication | | RS485 |
| | E | RS485, Ethernet |

※ Basic components (power module, Control module)

※ This product consists of power module/control module/Input module/output module 32 contacts, (digital input (DI) with up to 32 contacts, digital output (DO) with up to 32 contacts).

Components

| Product | Model | Content |
|---------------------|------------|---|
| Display part | TH510-1N□ | Display part (5.7" TFT LCD) |
| Control module | TH510-MAIN | Temperature & Humidity Control Module |
| Power module | TM-PWR | Power module |
| Input module | TM-DI | Module with 16 input contacts |
| Output module | TM-DO | Module with 8 output contacts |
| Input/output module | TM-DIO | Module with 8 input and 6 output contacts |

TH300 CE

Specifications

| Model | TH300 | |
|--------------------------------|--|---|
| Appearance |  | |
| W×H×D (mm) | 96.0×96.0×100.0 | |
| Program | 100 Pattern (100 segments / 1 pattern) max. 2000 segments | |
| Screen | TFT LCD 70.08 × 52.56 mm (3.5") | |
| Functions | Contact input (DI): 4 contacts, Contact output (DO): max. 12 contacts, RS232/485 | |
| Power voltage | 100-240 V a.c. 50/60 Hz (voltage fluctuation rate: ±10 %) | |
| Display accuracy | ● Temperature (°C) : ±0.2 % of FS ● Humidity (%RH) : ±2 % of FS | |
| Sampling cycle | 500 ms | |
| Input type | Pt100 Ω or 0-5 V d.c. | |
| Output | Control output (OUT) | ● ON : 24 V d.c. pulse voltage ● OFF : 0.1 V d.c. max. ● Pulse voltage (load resistance min. 800 Ω) ● Cycle time: 1 ~ 1000 sec |
| | Retransmission output (RET) | ● Temperature / humidity : 4 - 20 mA d.c. (load resistance max. 600 Ω) present value (PV), output volume (MV), set value (SV) ※by internal selection ● Resolution: approx. 7,000 ● Refresh interval : 500 ms |
| | Contact output (DO) | ● Relay : 8 contacts (1a X 8 contacts), N.O : 30 V d.c. 5 A, 240 V a.c. 5 A ● Transistor: 4 contacts (open collector output). 24 V d.c. 300 mA max |
| Control type | PID auto-tuning | |
| Ambient temperature & humidity | 0 ~ 50 °C, 20 ~ 90 % RH (Without condensation) | |
| Weight (g) | 850 | |

Suffix code

| Model | Code | Content |
|---------------|---|---|
| TH300 | <input type="checkbox"/> <input type="checkbox"/> | Programmable Temperature & Humidity Controllers |
| Communication | 1 | RS232C communication |
| | 2 | RS485/422 communication |
| Language | 1 | Korean/English (standard type) |
| | 2 | English/Chinese (simplified) |
| | 3 | English/Chinese (traditional) |

New product

High function

Programmable Temperature Humidity

Thermal shock Test control

Multi-channel

Economy Ignorance For freezer

Indicator

TEMPERATURE CONTROLLER

NP200

Specifications

| | | |
|--------------------------------|--------------------|---|
| Model | | NP200 |
| Appearance | |  |
| W×H×D(mm) | | 96.0×96.0×100.0 |
| Power voltage | | 100-240 V a.c. 50/60 Hz voltage fluctuation rate: ±10 % |
| Power consumption | | Max. 6.0 W / max. 10 VA |
| Input (Multi Input) | Thermocouple input | K, J, E, T, R, B, S, L, N, U, W, PLII, |
| | RTD | Pt100 (KS/IEC 751), KPt100 (KS) |
| | DC voltage input | 1-5 V d.c. 0 - 10 V, -10 - 20 mV, 0 - 100 mV |
| | DC Current input | 4 - 20 mA (Attach 250 Ω external resistor) |
| Control | | ● Relay output, voltage output (SSR), current output (SCR) ● Control behavior : PID control, ON/OFF control |
| Alarm type | | High/Low, High/Low deviation |
| Communication method | | RS485/422, 2-wire half-duplex or 4-wire half-duplex (by wiring method) |
| Setting | | By front Shift up, Down keys |
| Display | | PV : Digital LED, SV : Graphic LCD |
| Display accuracy | | 0.1 % of FS (Full Scale) |
| Setting accuracy | | 1 or 0.1 % (according to input range) |
| External control | | 4 alarm outputs (Run, Reset, Step, Hold) |
| Pattern | | 30 patterns, Up to 99 segments per pattern can be set |
| Segment | | 300 Segment |
| Set time unit of program | | Hours, minutes or minutes, seconds |
| Sampling cycle | | 100 ms |
| Insulation Resistance | | MIn. 500 V a.c. 20 MΩ |
| Dielectric strength | | 2300 V a.c. 50/60 Hz for 1 min (between 1st and 2nd terminals and between 1st terminal and ground) |
| Ambient temperature & humidity | | 0 ~ 50 °C, 35 ~ 85 % RH (Without condensation) |
| Weight (g) | | 696 |

Suffix code

| Model | Code | Content |
|--------------|---|---|
| NP200 | <input type="checkbox"/> <input type="checkbox"/> | Programmable Temperature Controller (96 X 96 mm) |
| Control type | 0 | Normal type (heating) |
| | 1 | Heating/cooling type (synchronous control type) |
| Option | 0 | None |
| | 1 | RS422 / 485 (Communication function) |
| | 2 | DI 4 contacts (DI 4~7) |
| | 3 | RS422 / 485(Communication function), DI 4contacts |

※ Selection specification of DI 1 to 3 standard mounting (DI 4 to 7)

Range and Input Type

| Classification | Input | Input code | Range(°C) | Accuracy | Relative height |
|------------------|--------------|--------------|---|--------------------------|---|
| Thermocouple(TC) | K | *1 K1 | -200.0 ~ 1370.0 | ±0.10 % of FS ±1digit | ※ Display Range: -5% of the above range ~ +105 % *1: Below 0°C : ±0.2 % of FS ±1digit *2 : 0 ~ 400 °C Range : ±5 % of FS ±2digit |
| | K | *1 K2 | -200.0 ~ 1000.0 | | |
| | J | *1 J | -200.0 ~ 1200.0 | | |
| | E | *1 E | -200.0 ~ 1000.0 | | |
| | T | *1 T | -200.0 ~ 400.0 | | |
| | R | R | 0 ~ 1700 | ±0.15 % of FS ±1digit | |
| | B | *2 B | 0 ~ 1800 | | |
| | S | S | 0 ~ 1700 | | |
| | L | *1 L | -200.0 ~ 900.0 | ±0.1 % of FS ±1digit | |
| | N | N | -200.0 ~ 1300.0 | ±0.2 % of FS ±1digit | |
| | U | *1 U | -200.0 ~ 400.0 | ±0.1 % of FS ±1digit | |
| W | W | 0 ~ 2300 | | | |
| Platinel II | Platinel2 | 0.0 ~ 1300.0 | | | |
| RTD | JPt100 | JPT100 | -200.0 ~ 500.0 | ±0.1 % of FS ±1digit | |
| | Pt100 | PT100 | -200.0 ~ 640.0 | | |
| DC Voltage(V) | 1 - 5 V | 1/5 V | Scaling range SL-L ~ SL-H = -2000 ~ 14000 | ±0.1 % of FS ±1digit | |
| | 0 - 10 V | 0/10 V | | | |
| DC Voltage(mV) | -10 - 20 mV | 10/20 mV | ※ If current input is used, attach a 250 Ω 0.1% resistance between terminals 19 and 20 to use it as a 4-20 mA d.c. input. | | |
| | 0 - 100 mV | 0/100 mV | | | |
| DC Current | 4-20 mA d.c. | 1/5 V※ | | | |

TS510 CE

Specifications

| | | | | |
|--------------------------------|--------------------------------|---|--|--|
| Model | | TS510 | | |
| Appearance | |  | | |
| W×H×D (mm) | | 145.0×145.0×33.5 | | |
| Power voltage | | 100 – 240 V a.c. Voltage fluctuation rate: ±10 % of power voltage ±10 % | | |
| Power frequency | | 50/60 Hz | | |
| Power consumption | | 30 VA max | | |
| Dielectric strength | | <ul style="list-style-type: none"> ● Between 1st and 2nd terminals: min. 1500 V a.c. for 1 min ● Between 1st terminal and FG: min. 1500 V a.c. for 1 min ● Between 2nd terminal and FG: min. 1500 V a.c. for 1 min | | |
| Input type | | <ul style="list-style-type: none"> ● Thermocouple 11 types (K, J, E, T, R, B, S, L, N, U, Wre 5-26) ±0.15 % of FS ±1 digit ● RTD 2 types (Pt-100, KPt-100) ±0.1 % of FS ±1 Digit, ● Current voltage 4 types (-10 ~ 20 mV, 0 ~ 100 mV, 1 ~ 5 V, 0 ~ 30 V) ±0.1 % of FS ±1 Digit | | |
| Sampling cycle | | 250 ms | | |
| Contact outputs (DO) | Relay contact max. 32 contacts | A contact | 30 V d.c. 3 A max, 250 V a.c. 3 A | |
| | | B contact | NO : 30 V d.c. 5 A max, 250 V a.c. 5 A | |
| Control output | SSR output | ON : 18 V d.c. Pulse voltage (Load resistance min. 800 Ω) | | |
| | SCR output | 4~20 mA d.c. (Load resistance max. 600 Ω) | | |
| Retransmission output | SCR output | 4~20 mA d.c. | | |
| | Current output | Load resistance max. 600 Ω | | |
| | Load resistance | Laboratory PV, Laboratory SV, hot chamber PV, cold chamber PV | | |
| | Output type | 250 ms | | |
| Input | Input correction | EUS(0 ~ 100 %) | | |
| | Input filter | 0 ~ 120 sec | | |
| Functions | Control output | | Output (SSR) or current output (4 ~ 20 mA d.c.) selection | |
| | Control operation | Test pattern | Max. 100, test type (10 types) selection per each pattern | |
| | | PID group | Hot chamber/cold chamber each 4 groups, deviation PID | |
| | | Auto-tuning | Auto-tuning according to target set value | |
| | | Proportional band | 0.00 ~ 100.00 % (for 0.00 %, ON/OFF control) | |
| | | Integral time/ Derivative time | 0.0 ~ 3000 sec. (OFF status when 0 sec is set) | |
| | | ON/OFF control | Set 0.0 to proportional band (PB) | |
| | | Direct/reverse action | Depending on the direct/reverse action selection of the control output | |
| | Direct/reverse action | ARW zone setting (50 ~ 1000 % of proportional band) | | |
| | Alarm setting | A.T GAIN | 0.0 ~ 10.0 | |
| Setting alarm | | System alarm 8 contacts | | |
| Alarm type | | High/Low absolute, High/Low deviation, Within/Out of range (alarm direction, hold) | | |
| | Absolute alarm setrange | EU (0 ~ 100 %) | | |
| Display | | TFT color LCD (115.2 × 86.4 mm) | | |
| Resolution | | 640 × 480 pixel | | |
| Back light | | LED back light | | |
| Back light life | | Approx. 40,000 h | | |
| Touch type | | Resistive type (4 Wires) | | |
| Language | | Korean/English/Chinese (simplified) | | |
| Saving functions | Internal memory | Non-volatile memory : 80 MB | | |
| | External memory | SD card (8 GB) | | |
| | Saving interval | 1 ~ 360 sec | | |
| Memory information | | Program information, set value, recovery, temperature set / process / output value | | |
| Ambient temperature & humidity | | 0 ~ 50 °C, 20 ~ 90 % RH (Without condensation) | | |
| Weight(g) | | Approx. 1.32 kg | | |

| |
|-----------------------------------|
| New product |
| High function |
| Programmable Temperature Humidity |
| Thermal shock Test control |
| Multi-channel |
| Economy Ignorance For freezer |
| Indicator |

Suffix code

| Model | Code | Content |
|--------------|--|--|
| TS510- | <input type="checkbox"/> <input type="checkbox"/> <input type="checkbox"/> | Thermal Shock Test Controller |
| Display part | 1 | 5.7" TFT-LCD |
| | N | None |
| Input/output | 1 | 16 input contacts · output 8 contacts (2 modules) + power module + control module |
| | 2 | 16 input contacts · 16 output contacts (3 modules) + power module + control module |
| | 3 | 16 input contacts · output 24 contacts (4 modules) + power module + control module |
| | N | No input/output |
| Language | S | Korean, English and Chinese (simplified) |
| | T | Korean, English and Chinese (traditional) |

Components

| Product | Model | Content |
|---------------------|------------|---|
| Display part | TS510-1N□ | Display part (5.7" TFT LCD) |
| Control module | TS510-MAIN | Temperature 3-channel control module |
| Power module | TM-PWR | Power module |
| Input module | TM-DI | Module with 16 input contacts |
| Output module | TM-DO | Module with 8 output contacts |
| Input/output module | TM-DIO | Module with 8 input and 6 output contacts |

※ This product basically consists of display and control parts (power, control, input, output modules). Digital input (DI) with up to 32 contacts, digital output (DO) with up to 32 contacts

TEMPERATURE CONTROLLER

TS500

Specifications

| Model | | TS500 |
|------------------------------------|------------------------|--|
| Appearance | |  |
| W×H×D (mm) | | 183.0×144.0×94.0 |
| Power voltage | | 100-240 V a.c. Voltage fluctuation rate: ±10 % |
| Power frequency | | 50/60 Hz |
| Power Consumed | | Body: 16 W max, I/O module: 10 W max. |
| Insulation resistance | | Between 1st and 2nd terminals, between 1st and 2nd and ground terminals: 20 MΩ and above / 500 V d.c. |
| Voltage Resistance | | Between 1st and 2nd terminals, between 1st and 2nd and ground terminals: 2000 V a.c. 1 minute |
| Input type | | <ul style="list-style-type: none"> ● Thermocouple 6 species (K, J, E, T, R, S) ±0.15% of FS ±1 digit ● Temperature-Resist (Pt-100) ±0.1% of FS ● Four types of current voltages (Ed.c., Vd.c., Ed.c.) ±0.1% of FS |
| Input Resolution | | 24 bit |
| Degree of Instruction | | 0.1 % of FS |
| Sampling cycle | | 500 ms |
| Input Resistance | | 1 MΩ or more |
| Maximum allowable track resistance | | 50 Ω or less / line (the line resistance is the same condition) |
| Memory Information | | Setup and Operation Information (Internal Flash and NVRAM) |
| R.J.C. Error | | ±1.0 °C (Thermocouples add error) |
| Control output | SSR output | ● 24 V d.c. Pulse (Load resistance max. 600 Ω), ● Minimum pulse width: 10 ms, ● Cycle time: 1 - 1000 s can be set |
| | SCR output | ● 4-20 mA d.c. (Load resistance max. 600 Ω), ● Output resolution: 16 bits, ● Output Degree: ± 0.1% of FS, ● Output ripple: 0.1% of FS |
| | Relay output | ● I/O module internal relay or external relay with TR output ● Built-in relay specification: NO → 250 V a.c. 5 A / 30 V d.c. 5A |
| Transmission Output (4 - 20 mA) | | ● TEST.PV / TEST.SV / H.PV / L.PV Selectable ● Output Degree: ± 0.1% of F.S. (accurate calibration possible) |
| Output Renewal Cycle | | 500 ms |
| Input/Output Board | Contact Input | Contact transistor input 16 points |
| | Output | Relay output 16 points (a COMMON with 4 contacts), Transistor output 8 points (can be driven directly from external SSR or external 24V relay) |
| | External Supply Power | 24 V d.c. Power output available (200 mA max.) |
| | Connection method | Body to I/O module serial connection (RS422) |
| Communication Specification | Communication method | RS232C, RS485 |
| | Protocol | MODBUS-ASCII |
| | Communication speed | 9600 bps ~ 115200 bps |
| | Communication distance | RS485: 1.2 km(256 node), RS232: 10 m(1:1) |
| Screen Specification | Screen Specification | Color STN LCD (115.17 × 86.37 mm : 5.7") |
| | Resolution | 320 X 240 Pixel, 256 Colors |
| | Back light | LED (Approx. 40,000 hours) |
| | Back light life | Approx. 40,000 h |
| | Touch type | Resistive Membrane (4 Wires) |
| Language | | Korean, English |
| Ambient temperature & humidity | | 0 ~ 50 °C, 20 ~ 90 % RH (Without condensation) |
| Storage temperature | | -25 ~ 70°C |
| Vibration | | 4.9m/s², 4-150 Hz, 2h |
| Impact | | 147 m/s², 6directions 3 times. |
| Weight (g) | | Approx. 2,350 |

Suffix code

| Model | Code | Content |
|--------------------|---|---|
| TS500- | <input type="checkbox"/> <input type="checkbox"/> | 2-Channel Programmable Temperature Controller |
| Types | N | No body (only I/O modules required) |
| | 1 | Body (RS232, RS485) |
| Input/output board | N | No I/O modules (if body only required) |
| | 1 | I/O module (16 relay points, 8 tr output points, 16 contact input points) |
| Language | | Korean/English |



Specifications

| Model | ML-D4 | ML-D2H | ML-E | | |
|--|--|--|-----------------------|---------------------|----------------|
| Appearance |  | | | | |
| W×H×D(mm) | 30.0×100.0×96.9 | | | | |
| Power voltage | 24 V d.c. | | | | |
| Voltage fluctuation rate | ±10 % of power voltage | | | | |
| Power consumption | ML-D4S/C Max.7W | ML-D4M Max.5W | ML-D2HMS/SS Max.7W | ML-D2H MM Max.5W | ML-E Max.3W |
| Thermocouple | K, J, E, T, R, B, S, L, N, U, W, PL2 | | | | |
| RTD | Pt 100 Ω, KPt 100 Ω | | | | |
| DC voltage | 0 - 100 mV, 1 - 5 V, 0 - 10 V | | | | |
| Sampling cycle | 50 ms | | | | |
| Input display resolution | Below minimum unit of input range | | | | |
| Input impedance | Thermocouple and DC voltage input: min. 1 MΩ | | | | |
| Allowable input | <ul style="list-style-type: none"> ● Allowable input voltage : Within -2 ~ 5 V (thermocouple, RTD), within -5 to 12 V (DC voltage) ● Effect of allowable input resistance : approximately 0.2 uV/Ω ● Permissible input line resistance: not more than 10 Ω of side temperature resistance. However, the resistance between the three lines will be the same) | | | | |
| Input correction | ±100% of input range | | | | |
| Reference junction compensation error | ±1.5 °C (0 ~ 50 °C) | | | | |
| Input disconnection detection (Burn-out) | up scale | | | | |
| Control Output | Relay | ● 1a contact ● 250 V a.c. 3 A, 30 V d.c. 3 A | | | |
| | Voltage output (SSR) | ● Approx. 12 V min (Load resistance min. 600 Ω) with short-circuit, limit to about 25 mA ● Time resolution: bigger between control cycle 0.1 % or 10 ms | | | |
| | Current output (SCR) | ● 4-20 mA d.c. (Load resistance min. 600 Ω) ● Accuracy: ±0.1 % of FS (4 - 20 mA range) | | | |
| RS232C communication | <ul style="list-style-type: none"> ● Communication method : RS-232 standard ● Max. communication distance : 15 m ● Communication speed : 9600 bps ● Start bit : 1 bit ● Data length : 8 bit ● Parity bit : Even ● Stop bit : 1 bit ● Supported protocol : PC-Link | | | | |
| RS485 communication | <ul style="list-style-type: none"> ● Max. number of connections : 31 units ● Communication sequence : No sequence ● Response time : Reception handling time + (response time x 10 ms) ● Stop bit : 1, 2 bit [initial value: 1] ● Data length : 7, 8 bit [initial value: 8] ● Parity bit : None, odd, even [initial value: even] ● Start bit : 1 bit ● Max. communication distance : 1200 m ● Communication method : RS485 standard / 2-wire half-duplex ● Supported protocol : PC-Link, PC-Link with SUM, Modbus ASCII/RTU [Initial value: PC-Link] ● Communication speed : 9600, 19200, 38400, 57600, 76800 bps [Initial value: 9600] | | | | |
| Ambient temperature & humidity | 0 ~ 50 °C / 35 ~ 85 % RH (Without condensation) | | | | |
| Operating environment | No toxic gases, magnetic fields or dust generating areas | | | | |
| Warming-up | At least 30 min | | | | |
| Ambient temperature influence | Thermocouple, DC voltage: bigger between ±3 uV / °C or ±0.03 % of FS / °C, RTD : ±0.1 °C / °C max | | | | |
| Power supply change influence | Bigger between ±3 uV / 10 V or ±0.03 % of FS / 10 V | | | | |
| Storage temperature & humidity | -25 ~ 65 °C / 5 ~ 95% RH (Without condensation) | | | | |
| Weight (g) | 220 | | | | |

| |
|-----------------------------------|
| New product |
| High function |
| Programmable Temperature Humidity |
| Thermal shock Test control |
| Multi-channel |
| Economy Ignorance For freezer |
| Indicator |

Suffix code

ML-D2H Modular Temperature Controllers

| Model | Code | Content |
|--------------------|-------|--|
| ML-D | 2 H □ | Modular Temperature Controller |
| Number of channels | 2 | 2 Channels |
| Input | H | Heating/cooling control (simultaneous), heater break alarm (HBA) |
| Control output | MM | OUT1 : Relay output / OUT2 : Relay output |
| | SM | OUT1 : SSR Output / OUT2 : Relay output |
| | SS | OUT1 : SSR Output / OUT2 : SSR Output |
| | CM | OUT1 : 4-20 mA d.c. / OUT2 : Relay output |
| | CS | OUT1 : 4-20 mA d.c. / OUT2 : SSR Output |
| | CC | OUT1 : 4-20 mA d.c. / OUT2 : 4-20 mA d.c. |

ML-D4 Modular Temperature Controllers

| Model | Code | Content |
|--------------------|------|--------------------------------|
| ML-D | 4 □ | Modular Temperature Controller |
| Number of channels | 4 | 4 Channels |
| Control output | M | Relay output |
| | S | SSR output (12 V d.c.) |
| | C | SCR output (4-20 mA d.c.) |

Ex: temperature controller 4 channel relay output : ML-D4M

ML-E Modular Event Outputs

| Model | Content |
|-------|--|
| ML-E | Modular Event Output Unit (8 contacts relay) |

TEMPERATURE CONTROLLER

MC9

Specifications

| Model | | MC9 | |
|--------------------------------|--|---|---|
| Appearance | |  | |
| W×H×D(mm) | | 96.0×96.0×100.0 | |
| Input | Thermocouple | K, J, R, S, B, E, N, T, W, PL2, U, L | |
| | RTD | Pt100 Ω, KPt100 Ω | |
| | DC voltage | 0-5 V, 1-5 V, 0-10 V, 4-20 mA (Attach 250 Ω external resistor) | |
| | Sampling cycle | 1 sec | |
| | Input display resolution | Basically, below the range decimal point | |
| | Input impedance | Thermocouple and DC voltage input: min. 1 MΩ | |
| | Allowable input resistance | Approx. 0.2 μV/Ω | |
| | Allowable input lead resistance | RTD (Max. 10 Ω. but the resistance among 3 lines should be same) | |
| | Allowable input voltage | Within -2 ~ 5 V (thermocouple, RTD), within -5 to 12 V (DC voltage) | |
| | Scaling | 0.0 % ~ 100.0 % of FS | |
| | Input correction | ±100 % of FS | |
| | Reference contact compensation error | ±1.5 °C (0 ~ 50 °C range) | |
| Input disconnection detection | | UP SCALE(Reverse action), DOWN SCALE(Direct action) | |
| Performance | Degree of indication | Thermocouple | Bigger between ±0.3 % of FS ±1 Digit or ±2 °C |
| | | RTD | Bigger between ±0.3 % of FS ±1 Digit or ±0.8 °C |
| | | DC voltage | ±0.3 % of FS ±1 Digit |
| | Insulation Resistance | 20 MΩ이상 (500 V d.c.), measuring terminal - power terminal | |
| Dielectric strength | 2,300 V a.c. 50/60 Hz, 1 min measuring terminal - power terminal | | |
| Control function and output | Control type | PID auto-tuning | |
| | Simultaneous channel setting | 4/8 channels simultaneous setting of the same value | |
| | Control operation | a) Reverse action (heating) / direct action (cooling). by "suffix code" b) Heating/cooling simultaneous control (4 channels only) | |
| | Setting range | Same as range and input code | |
| | Digital input (DI) | RUN/STOP or control zone selection by contact input | |
| | Auto-tuning | Auto-tuning by parameter selection | |
| | Proportional band | 0(0.0) to the maximum value of range | |
| | Integral time | 1 ~ 3,600 sec | |
| | Derivative time | 1 ~ 3,600 sec | |
| | ARW(Anti Reset Wind-up) | Auto, 0 ~ 100 % (Proportional band) | |
| | Gradient setting | 0(0.0) to max. range/1 min (gradient setting for target value) | |
| | Scan function | Displays the measured value and set value for each channel sequentially | |
| | ON/OFF control | Set the proportional band to "0" | |
| | Multi-memory zone | 8 zone selection for each channel | |
| | Heater break alarm (HBA) | 0.0 - 100.0 A (ON/OFF control, can be used on time proportional control output) | |
| | HBA dead band setting | 0 ~ 100 sec | |
| | Loop break alarm (LBA) | 0.1 ~ 200.0 min (dead band : 0 ~ 100 sec.) | |
| | Alarm output | Up to 3 contacts, parallel (OR) operation for all channels (by selected specifications) | |
| Alarm type | Selection by parameter | | |
| Control output | Relay output | <ul style="list-style-type: none"> ● Contact capacity : 1 a, 250 V a.c. 3 A (resistive load) ● Proportional period : 1 ~ 1000 sec ● Time resolution : Lower between 0.1 % or 10 ms | |
| | Voltage output (SSR) | <ul style="list-style-type: none"> ● Voltage pulse : approx. min. 12 V d.c. (load resistance min. 600 Ω) ● Proportional period : 1 ~ 1000 sec ● Time resolution : Lower between 0.1 % or 10 ms | |
| | Current output (SCR) | <ul style="list-style-type: none"> ● Current: 4 - 20 mA d.c., 0 - 20 mA (load resistance max. 600 Ω) ● Accuracy: ±1.0 % of FS (4 - 20 mA range) | |
| | Triac | 200 V a.c. 0.5 A (Ambient temperature 40 °C max), Zero Crossing function | |
| Alarm output (relay) | Temperature alarms (AL1,2,3) | 1 a, 250 V a.c., 1 A, 30 V d.c. 1 A (resistive load) / Output points: Max. 3 points (by selected specifications) | |
| | Heater break alarm (HBA) | <ul style="list-style-type: none"> ● Measuring current: 1 - 100 A a.c. (resolution: 0.5 A, ± 5 % of FS ± 1 Digit) ● CT for heater break detection: Model name JS81L (J&D Electronic.Co.Ltd) ● Accuracy: bigger between ± 5 % of FS or ± 2 A | |
| | Loop break alarm (LBA) | 1 a 1 contact, 250 V a.c., 1 A, 30 V d.c. 1 A (resistive load) / Proportional period: 1 ~ 1000 sec | |
| Power voltage | | 100-240 V a.c. 50/60 Hz | |
| Voltage fluctuation rate | | ±10 % of power voltage | |
| Power consumption | | 12 VA | |
| Ambient temperature & humidity | | 0 ~ 50 °C, 35 ~ 85 % RH (Without condensation) | |
| Storage temperature | | -25 ~ 65 °C | |
| Vibration resistance | | 10 - 55 Hz, single amplitude 0.75 mm, 3 axes each direction, 2 h | |
| Shock resistance | | 300 m/s ² , 3 axes each direction, 3 times | |
| Weight (g) | | 700 | |

Temperature controllers

Suffix code

MC9 (4 channels)

| Model | Code | Content |
|---|---|---|
| MC9-4 | <input type="checkbox"/> <input type="checkbox"/> <input type="checkbox"/> <input type="checkbox"/> <input type="checkbox"/> <input type="checkbox"/> | 4-Channel Digital Temperature Controllers |
| Control Type | D | For cooling control (Direct action) |
| | R | For heating control (Reverse action) |
| | W | Heating cooling simultaneous control |
| Input type | <input type="checkbox"/> | Refer to "Range and input code chart" |
| Heating output (output 1 ~ 4) | M | Relay contact output |
| | S | Output for SSR drive |
| | T | Output for Triac drive |
| | 4 | Current output (4-20 mA d.c.) |
| | 5 | Current output (0-20 mA d.c.) |
| Cooling output (output 5~8) * if control types are D and R then fix to N * if control type is W then select among M,S, t, 4 and 5 | N | None (if control output operation is DR) |
| | M | Relay contact output |
| | S | Output for SSR drive |
| | T | Output for Triac drive |
| | 4 | Current output (4-20 mA d.c.) |
| | 5 | Current output (0-20 mA d.c.) |
| Option | N | None |
| | 1 | AL2, AL3 |
| | 2 | AL2, AL3 + RS232 + contact input |
| | 3 | AL2, AL3 + RS485 / 422 + contact input |
| | 4 | AL2, AL3 + heater break |
| Power voltage | 2 | 100-240 V a.c. 50/60 Hz |

MC9 (8 channels)

| Model | Code | Content |
|---|---|---|
| MC9-8 | <input type="checkbox"/> <input type="checkbox"/> <input type="checkbox"/> <input type="checkbox"/> <input type="checkbox"/> <input type="checkbox"/> | 8-Channel Digital Temperature Controllers |
| Control Type | D | For cooling control (Direct action) |
| | R | For heating control (Reverse action) |
| Input type | <input type="checkbox"/> | Refer to "Range and input code chart" |
| Heating output (output 1 ~ 4) | M | Relay contact output |
| | S | Output for SSR drive |
| | T | Output for Triac drive |
| | 4 | Current output (4-20 mA d.c.) |
| | 5 | Current output (0-20 mA d.c.) |
| Cooling output (output 5~8) * if control types are D and R then fix to N * if control type is W then select among M,S, t, 4 and 5 | N | None (when selected, input channels 5 ~ 8 are for indication) |
| | M | Relay contact output |
| | S | Output for SSR drive |
| | T | Output for Triac drive |
| | 4 | Current output (4-20 mA d.c.) |
| | 5 | Current output (0-20 mA d.c.) |
| Option | N | None (alarm output AL1, 2, 3 built-in) |
| | 2 | RS232 + contact input |
| | 3 | RS485 / 422 + contact input |
| | 4 | heater break |
| Power voltage | 2 | 100-240 V a.c. 50/60 Hz |

| |
|-----------------------------------|
| New product |
| High function |
| Programmable Temperature Humidity |
| Thermal shock Test control |
| Multi-channel |
| Economy Ignorance For freezer |
| Indicator |

Range and input code chart

| Classification | Code | Input type | Range (°C) | Accuracy |
|-------------------|------|-------------|----------------|--|
| Thermocouple (TC) | K0 | K | -200 ~ 1370 | Bigger between ±0.3 % of FS ± 1 Digit or ±2 °C |
| | K1 | K | -199.9 ~ 999.9 | |
| | J0 | J | -200 ~ 1200 | |
| | J1 | J | -199.9 ~ 999.9 | |
| | E0 | E | -199.9 ~ 999.9 | |
| | E1 | E | -199.9 ~ 999.9 | |
| | T0 | T | -199.9 ~ 400.0 | |
| | R0 | R | 0 ~ 1700 | |
| | R1 | R | 0.0 ~ 999.9 | |
| | B0 | B | 0 ~ 1800 | |
| | B1 | B | 0.0 ~ 999.9 | |
| | S0 | S | 0 ~ 1700 | |
| | S1 | S | 0.0 ~ 999.9 | |
| | L0 | L | -199.9 ~ 900.0 | |
| | N0 | N | -200 ~ 1300 | |
| | N1 | N | -199.9 ~ 999.9 | |
| | U0 | U | -199.9 ~ 400.0 | |
| W0 | W | 0 ~ 2300 | | |
| A0 | PL2 | 0 ~ 1390 | | |
| RTD | P0 | KPt100 Ω | -199.9 ~ 500.0 | Bigger between ±0.3 % of FS ± 1 Digit or ±0.8 °C |
| | D0 | Pt100 Ω | -199.9 ~ 600.0 | |
| DC voltage(mV) | V0 | 0-5 V d.c. | -199.9 ~ 999.9 | ±0.3 % of FS ± 1 Digit |
| | V1 | 1-5 V d.c. | -199.9 ~ 999.9 | |
| | V2 | 0-10 V d.c. | -199.9 ~ 999.9 | |

※ When using current input, please attach 250 Ω 0.1% resistor to input signal terminal

TEMPERATURE CONTROLLER

MT100

Specifications

| Model | | MT100 |
|--------------------------------|--------------------------------------|--|
| Appearance | |  |
| W×H×D(mm) | | 155.0×130.0×16.5 |
| Input | Display screen | MONO LCD (128 X 64 mm) |
| | Temperature input (Multi Input) | 4 contacts, thermocouple (K,J), RTD (Pt 100 Ω) |
| | Sampling cycle | 1 Sec |
| | Measuring range | 0 ~ 300 °C |
| | Input correction | ±100 % of FS |
| | Input impedance | Approx. 1 MΩ (thermocouple input) |
| | Reference contact compensation error | ± 1.5 °C (0 ~ 50 °C range) |
| | Allowable input lead resistance | RTD (max. 10 Ω, but the resistance among 3 lines should be same) |
| | Input disconnection detection | UP SCALE(Reverse action), DOWN SCALE(Direct action) |
| | Pressure input | contact (4 - 20 mA d.c. or contact input) |
| | Pressure sampling cycle | 1sec. |
| | Pressure scale range | 0.00 ~ 10.00 (Decimal point fixed) |
| | Performance | Contact input |
| Display accuracy | | Temperature: ±0.3 % of FS ±1 Digit, pressure: ±3 % of FS ±1 Digit |
| Insulation Resistance | | Min. 20 MΩ (500 V d.c.) measuring terminal-power terminal |
| Dielectric strength | | 2300 V a.c., 50/60 Hz for 1 min (between measuring terminal and power terminal, between power terminal and ground terminal) |
| Control functions and output | Digital input (DI) | 8 contacts (① Option, ② Over pressure, ③ Overheating, ④ Over pump direct action, ⑤ Over pump reverse action, ⑥ Medium supplement termination, ⑦ Medium supplement start, ⑧ RUN/RESET) |
| | Current detection input | 3 phases (3 CT) |
| | Contact output (DO) | 6 contacts (① Option, ② Temperature alarms, ③ Inhale, ④ Ramp direct action, ⑤ Ramp reverse action, ⑥ Medium supplement) |
| | Control output | Cooling control output (relay) 1 contact, heating control output (SSR) 1 contact |
| | Reverse phase detection | 3-phase motor reverse rotation detection function |
| | Operation reservation | Reserve run time (time or weekly reservation) |
| | Forced cooling | When requiring sudden cooling, 100% cooling output after stopping heating output |
| | Preheating function | Control by preheating set value to prevent winter frost |
| | Abnormal history monitoring | Up to 20 errors can be memorized and displayed |
| | Control type | PID auto-tuning |
| | Proportional band | 0(0.0) to the maximum value of range |
| | Integral time | 1 ~ 3,600 sec |
| | Derivative time | 1 ~ 3,600 sec |
| | ARW(Anti Reset Wind-up) | Auto, 0 ~ 100 %((Proportional band) |
| | ON/OFF control | Set the proportional band to "0" |
| | Alarm type | 6 external alarms by contact input |
| Communication function | RS485/422 | |
| Control output | Cooling (relay) | ● Contact capacity: 1 a, 250 V a.c., 1 A, 30 V d.c. 1 A (resistive load) ● Proportional period: 1 ~ 1000 sec ● Time resolution: bigger between 0.1 % or 16.667 ms |
| | Heating (SSR) | ● Voltage pulse: approx. min. 12 V d.c. (load resistance min. 600 Ω) ● Proportional period: 1 ~ 1000 sec, ● Time resolution: bigger between 0.1 % or 16.667 ms |
| | Contact output 6 contacts (DO) | 1 a, 250 V a.c., 1 A, 30 V d.c. 1 A (Resistive load) |
| Communication specifications | | ● Communication method : 2-wire half-duplex or 4-wire half-duplex ● Max. number of connections : 31 ● Communication distance : 1,200 m ● Communication sequence : No sequence ● Communication speed: 9,600 bps ● Start bit : 1 bit ● Stop bit : 1 bit ● Data length : 8 bit ● Parity bit : NONE ● Protocol : PC-Link with SUM |
| Power voltage | | 100-240 V a.c. 50/60 Hz |
| Voltage fluctuation rate | | ±10 % of power voltage |
| Power consumption | | 8 VA |
| Ambient temperature & humidity | | 0 ~ 50 °C, 35 ~ 85 % RH (Without condensation) |
| Storage temperature | | -25 ~ 65 °C |
| Weight (g) | | 850 |

Suffix code

| Model | Code | Content |
|-------------------------|--|--|
| MT100 | <input type="checkbox"/> <input type="checkbox"/> <input type="checkbox"/> | Multi Input Mold Temperature Controller |
| Communication | 0 | No communication |
| | 1 | RS485/422 |
| Pressure inspection | 0 | No pressure inspection |
| | 1 | Pressure inspection by contact input |
| | 2 | Pressure inspection by 4 - 20 mA d.c. |
| Current inspection (HB) | 0 | HB None |
| | 1 | HB 3 contacts ※CT(CTL-6-S) sold separately |

BX8

Specifications

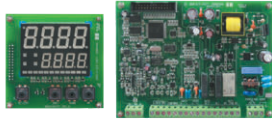
| Model | | BX8 | |
|--------------------|--|---|--|
| Appearance | |  | |
| Power voltage | | 100-240 V a.c. (Voltage fluctuation rate: ±10 %) | |
| Input | Input | <ul style="list-style-type: none"> ● Thermocouple : K, J, E, T, R, B, S, L, N, U, WR5-26, PL-II (Refer to input signal and measuring range) ● RTD : Pt100 Ω, KPt100 Ω, ● DC voltage input : 1 - 5 V, -10 - 20 mV, 0 - 100 mV (Freescale) | |
| | Sampling cycle | 250 ms | |
| | Input impedance | Thermocouple and DC voltage input (mV): min. 1 MΩ, DC voltage input (V): approx. 1 MΩ | |
| | Allowable signal source resistance | Thermocouple: max. 250 Ω, voltage: max. 2 kΩ | |
| | Lead wire allowable resistance | RTD : max. 10 Ω/1 wire (but the conductor resistance among 3 wires should be same) | |
| | Allowable input voltage | Within ±10 V (thermocouple, RTD, voltage: mV d.c.), within ±20 V (voltage: V d.c.) | |
| | Noise removal rate | NMRR (normal mode): 40 dB min (50/60 Hz ±1 %), CMRR (common mode): 120 dB min (50/60 Hz ±1 %) | |
| | Standard | Thermocouple/RTD (KS/IEC 751/DIN) | |
| | Reference contact compensation error | ±1.5 °C (15 ~ 35 °C interval), ±2.0 °C (0 ~ 50 °C interval) | |
| | Input disconnection detection (BURN-OUT) | Thermocouple: OFF, UP/DOWN Scale selection, RTD : UP Scale (thermocouple and RTD BURN-OUT) detection current: approx. 50 nA | |
| Measuring accuracy | ±0.5 % (FULL SCALE) | | |
| Output | Retransmission output | <ul style="list-style-type: none"> ● Current output range : 4-20 mA d.c. ● Load resistance : max. 600 Ω ● Resolution : approx. 3,000 ● Output refresh interval : 250 ms ● Accuracy : ±0.5% of max. scale (4 - 20 mA range) ● Output ripple : ±0.3% of max. scale (P-P) max. (150 Hz) | |
| | Alarm output (HBA) | <ul style="list-style-type: none"> ● Contact capacity : 240 V a.c. 1 A, 30 V d.c. 1 A (Resistive load) ● Contact configuration : 1 a ● Output points: Depending on model specifications (refer to connection diagram) ● Number of contacts : 1 contact · Current measuring range : 1 - 50 A a.c. (resolution: 0.5 A, ±5 % of max. scale ±1 digit) ● Alarm output : selectable in alarm output ● Dead band : 0 ~ 100 % of max. range ● Other : available during ON/OFF control or time proportional output (but not during current output or cooling output) ● Break detection is not possible below 0.2 sec. during output on | |
| | Control output | Relay contact output | <ul style="list-style-type: none"> ● Contact capacity : 240 V a.c. 3 A, 30 V d.c. 3 A (Resistive load) ● Contact configuration : 1 C ● Time resolution : smaller between 0.1 % or 10 ms ·Proportional period: 1 ~ 1000 s ● Output operation : Time proportional, ON/OFF ● ON / OFF hysteresis: 0 ~ 100 % (Full Scale) ● Output limit : 0.0 ~ 100.0 % range high limit (OH), low limit(OL) selectable (Also during auto-tuning) |
| | | SSR output (Voltage pulse output) | <ul style="list-style-type: none"> ● ON voltage: min. approx. 24 V d.c. (load resistance min. 600 Ω, 30 mA current limit during short circuit) ● Proportional period : 1 ~ 1000 s ● OFF voltage : max. 0.1 V d.c. ● Output operation: time proportional ● Time resolution : smaller between 0.1 % or 10 ms ● Output limit : 0.0~100.0 % range, high limit (OH) low limit(OL) selectable (also during AT) |
| | | Current output (4 - 20 mA) | <ul style="list-style-type: none"> ● Current output range : 4 - 20 mA d.c. ● Load resistance : max. 600 Ω ● Output refresh interval : 250 ms ● Output operation : continuous PID ● Accuracy : ±0.5% of max. scale (4 - 20 mA range) ● Resolution : approx. 3000 ● Output ripple : ±0.3% of max. scale (P-P) max. (150 Hz) ● Output limit : -5.0 ~ 105.0 %range, high limit (OH) low limit(OL) selectable (also during AT) |
| | Weight (g) | 300 | |

※ Control output : output can be selected from relay, current or SSR, heating / cooling type can be set individually.

Suffix code

| Model | Code | Content |
|--------------|---|---|
| BX8- | <input type="checkbox"/> <input type="checkbox"/> | Board Type Digital Temperature Controller |
| Control type | 0 | Normal |
| | 1 | Heating/cooling type |
| Option | 0 | SV2 / SV3 (Basic specifications: alarm output 2 contacts , (1 contact is determined by cooling output)) |
| | 1 | HBA |
| | 2 | RS485 |
| | 3 | HBA / RS485 |

| |
|-----------------------------------|
| New product |
| High function |
| Programmable Temperature Humidity |
| Thermal shock Test control |
| Multi-channel |
| Economy Ignorance For freezer |
| Indicator |

TEMPERATURE CONTROLLER

SM100 CE

Specifications





| Model | | SM100-□□12 | SM100-□□16 | SM100-□□20 |
|--------------------------------|---|---|-------------|--------------------------------|
| Appearance | |  | | |
| Number of channels | | 12 channels | 16 channels | 20 channels |
| Measurement input | Input type | ● Thermocouple (K), range : -199.9 °C ~ 999.9 °C / RTD (Pt100 Ω) | | ● Range : -199.9 °C ~ 640.0 °C |
| | Display accuracy | ±0.5 % of max. range (± 0.5 % of FS) | | |
| | RJC compensation accuracy | Within display accuracy | | |
| | Sampling cycle | 1 sec. | | |
| | Input correction | -1,200.0 °C ~ 1,200.0 °C | | |
| | Input filter | 0.0 ~ 120.0 sec. | | |
| | Burn-out operation | Thermocouple : Upscale RTD : Upscale | | |
| Settings and display | Setting method | Setting by communication program | | |
| | Number of settings | 12 contacts | 16 contacts | 20 contacts |
| | Memory Storage | Storage by Semiconductor | | |
| | Device address setting | Setting by built-in HEX BCD switch (1 to 15) | | |
| Display LED | Power indication, communication indication, control output indication | | | |
| Control output | Output Type | SSR driving voltage pulse output (driving voltage: 12 V d.c., load resistance min. 600 Ω) | | |
| | Control operation | Time proportional PID or ON/OFF control | | |
| | Number of PID groups | 1 Group / Channel | | |
| | Proportional cycle (output cycle) | 1 sec. ~ 100 sec. | | |
| | Proportional band (P) | 0 ~ 1200.0 °C | | |
| | Integral time (I) | 1 ~ 3600 sec. | | |
| | Derivative time (D) | 1 ~ 3600 sec. | | |
| | ARW (Anti Reset Wind-up) | 0.1 ~ 100.0 % ※ "0" setting (Auto) | | |
| | Manual reset | 0.0 ~ 100.0 % (During ON/OFF control) | | |
| | Hysteresis | 0 ~ 120.0 °C (During ON/OFF control) | | |
| | Control output operation | Cooling control (direct action) / heating control (reverse action) selection | | |
| Emergency output | 0.0 ~ 100.0 % | | | |
| Contact input | Number of external contact inputs | 1 contact (RUN/STOP by built-in dip switch) | | |
| | Communication standard | RS485/422(4-Wire type) | | |
| Communication specifications | Communication method | Half duplex | | |
| | Max. number of connections | 15 ※ Address setting by HEX BCD switch | | |
| | Communication sequence | No sequence | | |
| | Start bit | 1 Bit | | |
| | Stop bit | 1 Bit | | |
| | Parity bit | Even | | |
| | Data length | 8 Bit | | |
| | Transmission speed | 19200 bps | | |
| | Communication distance | 1.2 km max | | |
| | Communication protocol | PC Link with SUM | | |
| Response time | Reception handling time + (response setting time × 25 ms) | | | |
| Power voltage | 100 - 240 V a.c. 50/60 Hz (±10% of rated power voltage) | | | |
| Power consumption | max.25 VA | | | |
| Insulation resistance | Min. 20 MΩ. between power terminal and ground (500 V d.c. Mega) | | | |
| Dielectric strength | 2000 V a.c. for 1 min (between power terminal and ground) | | | |
| Ambient temperature & humidity | 0 ~ 50 °C, 20 ~ 85 % RH (Without condensation) | | | |
| Storage temperature | -20 °C ~ 70 °C | | | |
| Vibration resistance | 10 - 55 Hz 19.6 m/s ² 3 axes 6 directions 2 h | | | |
| Shock resistance | 196 m/s ² 3 axes 6 directions each 3 times | | | |
| Case material | Cold rolled steel plate (SPC) | | | |
| Weight (g) | 1270 | | | |

Suffix code

| Model | Code | Content |
|---|---------|--|
| SM100- | □ □ □ □ | Multi-channel Board Type Temperature Controller (basic specifications: alarm output 3 contacts, built-in run/stop SW 1 contact, RS485/422) |
| Input type | K | K(CA) thermocouple input (IEC 584-1) |
| | P | Pt100 Ω RTD input (IEC 751) |
| Output form | A | Control output (SSR driving voltage pulse output) |
| | N | No control output (Indication only) |
| Number of control contacts (Number of channels) | 20 | 20 Channels (standard product) |
| | 16 | 16 Channels |
| | 12 | 12 Channels |

HY-8000S/8200S/72D/48D

Specifications

| Model | | HY-8000S | HY-8200S | HY-72D | HY-48D |
|--------------------------------|------------------------------------|---|---|---|---|
| Appearance | |  |  |  |  |
| W×H×D(mm) | | 96.0×96.0×125.0 | 96.0×96.0×125.0 | 72.0×72.0×110.0 | 48.0×48.0×100.0 |
| Input | Thermocouple input | K | | | |
| | RTD input | Pt 100 Ω | | | |
| | Input sampling cycle | 500 ms | | | |
| | Input display resolution | 1 °C | | | |
| | Allowable signal source resistance | Thermocouple max. 100 Ω | | | |
| Performance | Lead wire allowable resistance | RTD (max. 10 Ω. but the resistance among 3 lines should be same) | | | |
| | Display accuracy | ±1 % of FS ±1 Digit | | | |
| Control functions and output | Dielectric strength | 2,000 V a.c. 50/60 Hz, for 1 min (among different live parts) | | | |
| | Control type | Proportional control, ON/OFF control (by suffix code) | | | |
| | Proportional band | 0.1 ~ 10.0 % of FS | | | |
| | Manual reset (MR) | ±50 % of mV (Output amount) | | | |
| | Proportional period | Output amount -50 ~ +50% | | | |
| | Hysteresis | 0.2 % fixed (During ON/OFF control) | | | |
| | Input disconnection detection | The output is OFF when the range is over 10 °C | | | |
| | Alarm type | HY-8200S model only, high absolute alarm | | | |
| Control output | Alarm setting range | Within range | | | |
| | Alarm hysteresis | 1 °C Fixed | | | |
| Control output | | Contact capacity : 1 C, 250 V a.c., 5 A (Resistive load) | | | |
| Alarm output | | Contact capacity : 1 c, 250 V a.c., 5 A (Resistive load) ※ HY-8200S model only | | | |
| Power voltage | | 110/220 V a.c. 50/60 Hz HY-48D model is 110/220 V by internal switch. | | | |
| Voltage fluctuation rate | | ±10% of power voltage | | | |
| Power consumption | | Max. 3 VA | | | |
| Ambient temperature & humidity | | 0 ~ 50 °C, 35 ~ 85 % RH (Without condensation) | | | |
| Storage temperature | | -25 ~ 65 °C | | | |
| Weight (g) | | 700 | 750 | 500 | 450 |

New product
High function
Programmable Temperature Humidity
Thermal shock Test control
Multi-channel
Economy Ignorance For freezer
Indicator

Suffix code

| Model | Code | Content |
|--|------------------|---|
| HY- | □- □ □ □ □ □ □ □ | Economical Digital Temperature Controller |
| Appearance | 8000S | 96(W) X 96(H) mm |
| | 8200S | 96(W) X 96(H) mm (High alarm standard) |
| | 72D | 72(W) X 72(H) mm |
| | 48D | 48(W) X 48(H) mm |
| Control type | P | Proportional control |
| Input | K | K thermocouple |
| | P | RTD Pt 100 Ω (IEC 751) |
| Control output | M | Relay output |
| Alarm output | N | None |
| | O | High alarm (HY-8200S) |
| Control operation (internal selection) | R | Reverse action (heating control) |
| Range Code | | Refer to "Range and input code chart" |



Range and input code chart

| Classif. | Code | Input | Range (°C) | | |
|--------------|------|---------|-----------------|----------|---------|
| | | | HY-8000S, 8200S | HY-72D | HY-48D |
| Thermocouple | 5 | K | - | - | 0 ~ 399 |
| | 8 | | 0 ~ 399 | 0 ~ 399 | |
| | 12 | | - | 0 ~ 1199 | |
| | 13 | | 0 ~ 1199 | | |
| RTD | 3 | Pt100 Ω | | | 0 ~ 199 |
| | 5 | | - | - | 0 ~ 399 |
| | 6 | | 0 ~ 199 | 0 ~ 199 | - |
| | 8 | | | 0 ~ 399 | |

TEMPERATURE CONTROLLER

DF series

Specifications

| Model | | DF2 | DF2(SUB) | DF4 (8-pin type) |
|--------------------------------|------------------------------------|---|--|---|
| Appearance | |  |  |  |
| W×H×D(mm) | | 48.0×96.0×100.0 | 48.0×96.0×100.0 | 48.0×48.0×86.0 |
| Input | Thermocouple input | K | | |
| | RTD input | KPt100 Ω, Pt100 Ω | | |
| | Input sampling cycle | 500 ms | | |
| | Input display resolution | 1 °C | | |
| | Allowable signal source resistance | Thermocouple max. 100 Ω | | |
| Performance | Lead wire allowable resistance | RTD (max. 10 Ω, but the resistance among 3 lines should be same) | | |
| | Display accuracy | ±1 % of FS ±1 Digit | | |
| Control functions and output | Control type | Proportional control | | ON/OFF control (by suffix code). |
| | Control operation | Reverse action or direct action (by suffix code) | | |
| | Setting range | Same as range and input code | | |
| | Proportional band | 3 % of FS | | 1 ~ 10 % of FS |
| | Manual reset (MR) | -50 ~ +50 % (Output amount) | | |
| | Proportional period | Approx. 20 sec (relay output), approx. 2 sec (voltage output (SSR)) | | |
| | Hysteresis | 0.2 % fixed (During ON/OFF control) | | |
| | Input disconnection detection | The output is OFF when the range is over 10 °C | | |
| | Sub output (SUB) | By suffix code (DF2 model only) | | - |
| Control output | Sub output setting range | Within range | | |
| | Sub output hysteresis | 1 °C fixed | | |
| | Relay output | Contact capacity: 1 C, 250 V a.c. 3 A (Resistive load) | | |
| Alarm output | Voltage output (SSR) | Approx. min. 12 V d.c. (Load resistance min. 800 Ω) | | |
| | Current output (SCR) | 4~20 mA d.c. (Load resistance max. 600 Ω) | | |
| Power voltage | Relay output | Contact capacity: 1 C, 250 V a.c. 3 A (Resistive load) | | |
| | Power voltage | 110/220 V a.c. 50/60 Hz | | ※ 110 V a.c., 220 V a.c. 50/60 Hz |
| Voltage fluctuation rate | | ±10 % of power voltage | | |
| Power consumption | | Max. 3 VA | | |
| Ambient temperature & humidity | | 0 ~ 50 °C, 35 ~ 85 % RH (Without condensation) | | |
| Storage temperature | | -25 ~ 65 °C | | |
| Weight (g) | | 450 | | 200 |

※ DF4 Power voltage can be 110 V or 220 V, depending on the specifications

Suffix code

| Model | Code | Content |
|--|---|---|
| DF | <input type="checkbox"/> <input type="checkbox"/> <input type="checkbox"/> <input type="checkbox"/> <input type="checkbox"/> <input type="checkbox"/> | Economical Digital Temperature Controller |
| Appearance | 2 | 48(W) X 96(H) mm |
| | 4 | 48(W) X 48(H) mm (socket type, 8-pin) |
| Control type | P | Proportional control |
| Input | K | K thermocouple |
| | P | RTD Pt100 Ω (IEC751) |
| Control output | M | Relay output |
| Sub output (SUB) ※ Only DF2 model | N | None |
| Control operation (internal selection) | R | Reverse action (heating control) |
| Range code | | Refer to "Range and input code chart" |

※ DF4 model selects proportional control/ON-OFF control by using internal dip switch.

※ Model DF4 with 110 V power voltage is available (order-made)





Range and input code chart

| Classification | Code | DF2 | |
|----------------|------|---------|------------|
| | | Input | Range (°C) |
| Thermocouple | 7 | K | 0 ~ 399 |
| RTD | 7 | Pt100 Ω | 0 ~ 399 |

| Thermocouple | Code | DF4 | |
|--------------|------|---------|------------|
| | | Input | Range (°C) |
| 열전대 | 6 | K | 0 ~ 399 |
| RTD | 6 | Pt100 Ω | 0 ~ 399 |

HY-2000, HY-1000, ND4

Specifications

| Model | | HY-2000 | HY-1000 | ND4 | ND4(For socket) |
|--------------------------------|------------------------------------|---|---|---|---|
| Appearance | |  |  |  |  |
| W×H×D(mm) | | 96.0×96.0×103.9 | 72.0×72.0×109.2 | 48.0×48.0×79.5 | 48.0×48.0×78.0 |
| Input | Thermocouple | K, J (J Type is for HY-2000 only) | | | |
| | RTD | Pt100 Ω(IEC751) | | | |
| | Allowable signal source resistance | Max. 100 Ω (thermocouple input) | | | |
| | Lead wire allowable resistance | RTD max. 10 Ω. (but the resistance among 3 lines should be same) | | | |
| Control functions and output | Control type | Proportional control, ON/OFF control (by suffix code) | | | |
| | Control operation | Reverse action or direct action (by suffix code) | | | |
| | Setting range | Same as input range chart | | | |
| | Proportional band | 3 % of FS(Fixed) | | | |
| | Proportional period | Approx. 25 ~ 30 sec (Relay output), Approx. 2 ~ 4 sec (voltage output (SSR)) | | | |
| | Hysteresis | Approx. 2 % of FS, fixed (ON/OFF control, 400 °C standard) | | | |
| | Input disconnection detection | Output OFF when range is over | | | |
| | Control output | Relay (1 c, 250 V a.c., 3 A resistive load) | | | |
| Power voltage | | 110/220 V a.c. 60 Hz (But for ND4, 110 V a.c. or 220V a.c. are separated) | | | |
| Voltage fluctuation rate | | ±10 % of power voltage | | | |
| Power consumption | | Max. 3 VA | | | |
| Dielectric strength | | 2000 V a.c. 50/60 Hz for 1 min (Between different live parts) | | | |
| Ambient temperature & humidity | | 0 ~ 50 °C, 35 ~ 85 % RH (without condensation) | | | |
| Storage temperature | | -25 ~ 65 °C | | | |
| Weight (g) | | 400 | | 200 | |

New product

High function

Programmable Temperature Humidity

Thermal shock Test control

Multi-channel

Economy Ignorance For freezer

Indicator

Suffix code

| Model | Code | Content |
|--------------------|--|--|
| HY-1000 | | Temperature Controller Without Indicator |
| HY-2000 | <input type="checkbox"/> <input type="checkbox"/> <input type="checkbox"/> <input type="checkbox"/> <input type="checkbox"/> <input type="checkbox"/> <input type="checkbox"/> | |
| ND4 | | |
| Control type | F | ON/OFF control (2 position control) |
| | P | Proportional control |
| Input | K | K thermocouple |
| | P | RTD Pt100 Ω(IEC751) |
| Control output | M | Relay |
| Alarm output | N | None (※ For ND4 model, no indication) |
| Control operation | R | Reverse action (Heating control) |
| | D | Direct action (Cooling control) |
| Range code | | Refer to "Range and input code chart" |
| Terminal structure | T | ND4 Terminal type |

※ Specify the power voltage of ND4 separately (110 V a.c. or 220 V a.c.)

Range and input code chart

■ HY-2000, HY-1000

| Code | HY-2000 | | HY-1000 | |
|------|---------|------------|---------|------------|
| | Input | Range (°C) | Input | Range (°C) |
| 5 | Pt | 0 ~ 200 | Pt | 0 ~ 200 |
| 7 | Pt, K | 0 ~ 400 | Pt, K | 0 ~ 400 |
| 10 | K | 0 ~ 1200 | | |
| 11 | | | K | 0 ~ 1200 |

■ ND4

| Code | ND4 | |
|------|-------|------------|
| | Input | Range (°C) |
| 1 | Pt | -50 ~ 50 |
| 2 | Pt | -100 ~ 100 |
| 3 | Pt | 0 ~ 100 |
| 5 | Pt, K | 0 ~ 200 |
| 6 | Pt, K | 0 ~ 300 |
| 7 | Pt, K | 0 ~ 400 |

TEMPERATURE CONTROLLER

BR6A

Specifications

| Model | BR6A | |
|--------------------------------|--|---|
| Appearance |  | |
| W×H×D(mm) | 74.9×32.9×69.3 | |
| Power consumption | Max. 5 VA (220 V a.c. 60 Hz) | |
| Input sensor | Hanyoung Nux exclusive sensor (TH-570N) ※ Thermistor (-50.0 ~ 150.0 °C) | |
| Accuracy | ±1 % of FS ±1 Digit | |
| Control output (Main output) | Relay output | Contact configuration: 1c, 250 V a.c. 5A (resistive load) |
| | SSR | 10 V d.c. min (load resistance min. 500 Ω) |
| Alarm / Defrost | Relay | Contact configuration: 1c, 250 V a.c. 5A (resistive load) |
| Control operation | Proportional operation (P control), ON/OFF operation | |
| Setting method | Set, increase, decrease, digital method by shift key | |
| Other features | Defrost timer, alarm function, heating/cooling dual usage | |
| Ambient temperature & humidity | 0 ~ 50 °C, 35~85 % RH (Without condensation) | |
| Line resistance | Max. 10 Ω for 1 wire | |
| Weight | 120 | |

Suffix code

| Model | Code | Content |
|----------------|--|---|
| BR6A - | <input type="checkbox"/> <input type="checkbox"/> <input type="checkbox"/> <input type="checkbox"/> <input type="checkbox"/> | Digital Temperature Controller (Proportional control, ON/OFF control selectable by setting) |
| Input | N | Hanyoung Nux exclusive sensor (TH-570N) ※ Thermistor |
| Control output | M | Relay Contact outputs |
| | S | SSR output (Voltage pulse 12 V d.c.) |
| Option | 0 | None (basic specifications: alarm output 1 contact) |
| | 1 | Communication (RS-485, MODBUS ASCII / RTU) |
| Power voltage | P4 | 100-240 V a.c. 50/60 Hz |
| LED color | W | White LED |
| | R | Red LED |

BR6 CE

Specifications

| Model | BR6 | |
|--------------------------------|--|--|
| Appearance |  | |
| W×H×D(mm) | 77.0×35.0×70.5 | |
| Power voltage | 100-240 V a.c. 50/60 Hz, 10-24 V a.c. 50/60 Hz or 10-24 V d.c. | |
| Power consumption | Max. 5 VA (220 V a.c. 60 Hz) | |
| Input sensor | Hanyoung Nux exclusive sensor (TH-540N) ※ Thermistor (NTC) (-40.0 ~ 90.0 °C) | |
| Accuracy | ±1 % of FS ±1 digit | |
| Control output (Main Output) | Relay output | Contact configuration: SPDT, 250 V a.c., 5 A (resistive load) |
| | SSR | Approx. 5 V d.c. (load resistance min. 500 Ω) max. approx. 50 mA |
| Control type | ON / OFF, Proportional control selectable by setting | |
| Setting method | Set, increase, decrease, digital method by key | |
| Other features | Defrost timer, alarm function, heating / cooling dual usage | |
| Ambient temperature & humidity | 0 ~ 50 °C, 35 ~ 85 % RH (Without condensation) | |
| Weight (g) | 116 | |

Suffix code

| Model | Code | Content |
|----------------|---|---|
| BR6- | <input type="checkbox"/> <input type="checkbox"/> <input type="checkbox"/> <input type="checkbox"/> | Digital Temperature Controller (basic specifications: alarm output 1 contact) |
| Control type | F | ON/OFF, Proportional control selectable by setting |
| Input | N | Hanyoung Nux exclusive sensor (TH-540N) ※ Thermistor |
| Control output | M | Relay |
| | S | SSR (Voltage pulse output 5 V d.c.) |
| Power voltage | P3 | 10-24 V a.c. 50/60 Hz or 10-24 V d.c. |
| | P4 | 100-240 V a.c. 50/60 Hz |

ED6 CE

Specifications

| | | |
|--------------------------------|--|--|
| Model | ED6 | |
| Appearance |  | |
| W×H×D(mm) | 77.0×35.0×70.5 | |
| Power voltage | 100-240 V a.c. 50/60 Hz, 10-24 V a.c. 50/60Hz or 10-24 V d.c. | |
| Power consumption | 5.5 VA | |
| Input sensor | K, Pt100 Ω, 4-20 mA d.c., 1-5 V d.c. | |
| Accuracy | ± 0.5 % of FS ±1 Digit | |
| Control output (Main Output) | Relay output | Contact configuration: 1 c, 250 V a.c. 5 A (resistive load) |
| | SSR | Approx. 5 V d.c. (load resistance min. 500 Ω) max. approx. 50 mA |
| Control type | Proportional control, ON/OFF control selectable by setting | |
| Setting method | Set, increase, decrease, digital method by key | |
| Other features | Sub output (alarm, defrost timer), heating / cooling dual usage | |
| Ambient temperature & humidity | 0 - 50 °C, 35 ~ 85 % RH (Without condensation) | |
| Weight (g) | 116 | |

| |
|-----------------------------------|
| New product |
| High function |
| Programmable Temperature Humidity |
| Thermal shock Test control |
| Multi-channel |
| Economy Ignorance For freezer |
| Indicator |

Suffix code

| Model | Code | Content |
|----------------|--|---|
| ED6 | <input type="checkbox"/> <input type="checkbox"/> <input type="checkbox"/> <input type="checkbox"/> <input type="checkbox"/> | Digital Temperature Controller |
| Control type | F | ON/OFF, Proportional control selectable by setting |
| Input | K | Thermocouple K |
| | P | RTD Pt100 Ω (IEC751) |
| | C | 4-20 mA d.c. (External resistance 250 Ω installation), 1-5 V d.c. |
| Control output | M | Relay output |
| | S | SSR (Voltage pulse output 5 V d.c.) |
| Power voltage | A | Alarm or defrost timer (Alarm or Defrost) |
| | N | None |
| Power voltage | P3 | 10-24 V a.c. 50/60Hz or 10-24 V d.c. |
| | P4 | 100-240 V a.c. 50/60 Hz |

HD6

Specifications

| | | |
|--------------------------------|--|--|
| Model | HD6 | |
| Appearance |  | |
| W×H×D(mm) | 77.0×35.0×70.5 | |
| Power voltage | 100-240 V a.c. 50/60 Hz | |
| Power consumption | Max. 2 VA | |
| Input sensor | TH-540N (103ET: -40.0 ~ 90.0 °C, 2 m ~ 20 m) | |
| Accuracy | ±1 % + 1 Digit of display value | |
| Control output (relay contact) | OPEN OUT: 250 V a.c. 5 A, CLOSE OUT: 250 V a.c. 5 A | |
| Control type | ON/OFF control (control by temperature and time) | |
| Setting method | Digital method by FND and button | |
| Other features | Green house operation / window closing motor control output | |
| Ambient temperature & humidity | 0 ~ 50 °C, 35 ~ 85 % RH (Without condensation) | |
| Weight(g) | 116 | |

Suffix code

| Model | Code | Content |
|----------------|---|--|
| HD6 | <input type="checkbox"/> <input type="checkbox"/> <input type="checkbox"/> <input type="checkbox"/> | Cost-Effective Digital Temperature Controller |
| Control type | F | ON/OFF control |
| Input | N | Hanyoung Nux exclusive sensor (TH-540N) ※ Thermistor |
| Control output | M | Relay |
| Power voltage | P4 | 100-240 V a.c. 50/60 Hz |

TEMPERATURE CONTROLLER

BK3

Specifications

| | | |
|--------------------------|---|--|
| Model | | BK3 |
| Appearance | |  |
| W×H×D(mm) | | 96.0×48.0×100.2 |
| Input | Thermocouple | K, J, R (But "R" type thermocouple only applies to BK3 models) |
| | Input sensor | RTD : Pt100 Ω(IEC 751) |
| | DC voltage | 0-5 V d.c., 1-5 V d.c., 0-10 V d.c. |
| | DC current | 4-20 mA d.c. |
| | Input sampling cycle | 500 ms |
| | Input display resolution | Basically below 1 °C (0.1 °C) of present value |
| | Input impedance | 1 MΩ (Thermocouple and DC voltage) |
| | Allowable signal source resistance | Thermocouple (max. 100 Ω), DC voltage (max. 2 kΩ) |
| | Lead wire allowable resistance | RTD (max. 10 Ω) but the resistance among 3 lines should be same |
| Allowable input voltage | Within ±10 V d.c. (thermocouple, RTD, DC voltage) | |
| Performance | Display accuracy | ±0.5 % of FS ±1 Digit (But, for R input, 599 °C max. is not guaranteed) |
| | Insulation Resistance | Min. 20 MΩ (500 V d.c.) |
| | Dielectric strength | 2,000 V a.c. 50/60 Hz, for 1 min (between different live parts) |
| Power voltage | | 110/220 V a.c. 50/60 Hz(Universal) |
| Voltage fluctuation rate | | ±10 % of power voltage |
| Power consumption | | Max. 4 VA |
| Ambient temperature | | 0 ~ 50 °C |
| Storage temperature | | -25 ~ 65 °C |
| Vibration resistance | | 10 - 50 Hz, single amplitude X·Y·Z each direction, 2h |
| Shock resistance | | 300 m/s ² X·Y·Z each direction each 3 times |
| Weight (g) | | 350 |

Suffix code

| Model | Code | Content |
|-------|--------------------------|--|
| BK3- | <input type="checkbox"/> | Digital Temperature Indicator |
| Input | K | K thermocouple (refer to range and input code chart) |
| | K1 | |
| | J | J thermocouple |
| | R | R thermocouple |
| | P1 | RTD Pt100 Ω (refer to range and input code chart) |
| | P2 | |
| | G | 0-5 V d.c. |
| | V | 1-5 V d.c. |
| | F | 0-10 V d.c. |
| | C | 4-20 mA d.c. |

Range and input code chart

| Classification | Code | Input | Range (°C) |
|----------------|------|----------------|-------------------|
| Thermocouple | K | K thermocouple | 0 ~ 1,300 °C |
| | K1 | | 0.0 ~ 200.0 |
| | J | J thermocouple | 0 ~ 400 |
| | R | R thermocouple | 599 ~ 1,699 |
| RTD | P1 | Pt100 Ω | -199 ~ 600 °C |
| | P2 | | -199.9 ~ 199.9 °C |
| Direct voltage | G | 0-5 V d.c. | 0 ~ 100 |
| | V | 1-5 V d.c. | |
| | F | 0-10 V d.c. | |
| Direct current | C | 4-20 mA d.c. | |

BK6-M

Specifications

| | | | |
|--------------------------------------|---|---|------------------------|
| Model | | BK6-M | |
| Appearance | |  | |
| W×H×D(mm) | | 72.0×36.0×87.5 | |
| Input | Input | Multi Input selectable by setting | |
| | Thermocouple | K, J, E, T, R, B, S, L, N, U, W, PL2 | |
| | RTD | Pt 100 Ω(IEC 751), KPt 100 Ω | |
| | Input sampling cycle | 500 ms | |
| | DC voltage | 1-5 V d.c. (4-20 mV d.c.), -10-20 mV d.c., 0-100 mV d.c. | |
| | Input impedance | ● Thermocouple and DC voltage input (mV) : min. 1 MΩ ● DC voltage input(V) : approx. 1 MΩ | |
| | Allowable signal source resistance | Thermocouple (max. 100 Ω) DC voltage (max. 2 kΩ) | |
| | Allowable wiring resistance | RTD max. 10 Ω (but the resistance among 3 lines should be same) | |
| | Allowable input voltage | Within ±10 V (thermocouple, RTD, DC voltage (mV)). within ±20 V (DC voltage (V)) | |
| | Input correction | Correction by internal parameter | |
| Reference contact compensation error | ±2.0 °C (0 ~ 50 °C) | | |
| Performance | Accuracy | Thermocouple | ±0.5 % of FS ±1 Digit) |
| | | RTD | ±0.5 % of FS ±1 Digit) |
| | | DC voltage / current | ±0.5 % of FS ±1 Digit) |
| | Insulation resistance | Min. 20 MΩ (500 V d.c.) | |
| | Dielectric strength | 2,000 V a.c. 50/60 Hz 1 minute (Between different live parts) | |
| Power voltage | 100-240 V a.c. 50/60 Hz | | |
| Voltage fluctuation rate | ±10 % of power voltage | | |
| Power consumption | Max. 4 VA | | |
| Ambient temperature & humidity | 0 ~ 50 °C, 35 ~ 85% RH (Without condensation) | | |
| Storage temperature | -25 ~ 65 °C | | |
| Weight (g) | 120 | | |

| |
|-----------------------------------|
| New product |
| High function |
| Programmable Temperature Humidity |
| Thermal shock Test control |
| Multi-channel |
| Economy Ignorance For freezer |
| Indicator |

Suffix code

| Model | Code | Content |
|--------|------|--|
| BK6-M | □ | Multi InputDigital Temperature Indicator |
| Option | 0 | None |
| | 1 | RET (Retransmission output 4 - 20 mA d.c.) |

Range and input code chart

| Classification | Code | Input | Range (°C) | Accuracy | 비고 | |
|-------------------------------|------|-------------|------------|-----------------|-----------------------|--|
| Thermocouple(TC) | 1 | K | *2 | -200 ~ 1370 | ±0.5 % of FS ±1 digit | *1) 0 to 400°C range: ±10% of FS ±1 digit *2) Below 0°C: ±1.0 % of FS ±1 digit *3) -150.0 to 150.0°C below: ±1.0% of FS ±1 digit *4) When using current input, select code number "30" and attach a 250 Ohm 0.1% resistance to the input signal terminal. |
| | 2 | K | *2 | -199.9 ~ 999.9 | | |
| | 3 | J | *2 | -199.9 ~ 999.9 | | |
| | 4 | E | *2 | -199.9 ~ 999.9 | | |
| | 5 | T | *2 | -199.9 ~ 400.0 | | |
| | 6 | R | *2 | 0 ~ 1700 | | |
| | 7 | B | *1 | 0 ~ 1800 | | |
| | 8 | S | | 0 ~ 1700 | | |
| | 9 | L | *2 | -199.9 ~ 900.0 | | |
| | 10 | N | | -200 ~ 1300 | | |
| | 11 | U | *2 | -199.9 ~ 400.0 | | |
| | 12 | W | | 0 ~ 2300 | | |
| | 13 | Platinel II | | 0 ~ 1390 | | |
| RTD (RTD) | 20 | KPt100 Ω | *3 | -199.9 ~ 500.0 | ±0.5 % of FS ±1 digit | |
| | 21 | Pt100 Ω | *3 | -199.9 ~ 640.0 | | |
| Voltage/Current (VDC / mV DC) | 30 | 5 V d.c. | | 1-5 V d.c. | ±0.5 % of FS ±1 digit | |
| | 32 | 20 mV d.c. | | 10 - 20 mV d.c. | | |
| | 33 | 100 mV d.c. | | 0 - 100 mV d.c. | | |
| DC Current | 30 | 20 mA d.c. | *4 | 4-20 mA d.c. | | |

TEMPERATURE CONTROLLER

HN100 CE

Specifications

| | | | |
|--------------------------|-----------------------------|--|---|
| Model | | HN100 | |
| Appearance | |  | |
| W×H×D(mm) | | 275.0×170.0×34.4 | |
| Input | Input sensor | RTD : Pt 100 Ω(IEC 751) | |
| | Input sampling cycle | 500 ms | |
| | Input display resolution | Basically below 1 °C (0.1 °C) of present value | |
| | Allowable wiring resistance | RTD (max. 10 Ω. but the resistance among 3 lines should be same) | |
| Performance | Accuracy | RTD | ±(0.5% ±1 digit of displayed value) or ±2 °C (the bigger) |
| | | 4-20mA d.c. | |
| | Insulation resistance | Min. 20 MΩ (500 V d.c.) | |
| Dielectric strength | | 2,000 V a.c. 50/60 Hz, for 1 min (between different live parts) | |
| Power voltage | | 12 V d.c. (Power line length: 1.8 m standard) | |
| Voltage fluctuation rate | | ±10 % of power voltage | |
| Power consumption | | Max. 5 VA | |
| Ambient temperature | | -10 ~ 70 °C | |
| Storage temperature | | -25 ~ 80 °C | |
| Weight (g) | | 1,900 | |

Suffix code

| Model | Code | Content |
|-----------------|---|---|
| HN100- | <input type="checkbox"/> <input type="checkbox"/> | Digital Temperature Indicator |
| Input | 1 | RTD Pt100 Ω |
| | 2 | 4-20 mA d.c. (※measuring range: 0~100 °C fixed) |
| Measuring range | 1 | -100 ~ 400 °C |
| | 2 | -19.9 ~ 99.9 °C |

Range and input code chart

| Classification | Input | Range (°C) |
|----------------|----------------|--------------|
| Thermocouple | Pt100 Ω (IEC) | -100 ~ 400 |
| | | -19.9 ~ 99.9 |
| DC current | 4-20 mA d.c. | 0 ~ 100 |
| Sensor Length | 1.5 m standard | |

GR200 CE

Specifications

| Model | | GR200 |
|------------------------|-----------------------------|--|
| Appearance | |  <p>5.7"</p> |
| W×H×D(mm) | | 145.0×145.0×173.5 |
| Power voltage | | 100-240 V a.c. (Voltage fluctuation rate ±10 %) |
| Power frequency | | 50/60 Hz |
| Power consumption | | Max. 22 VA |
| Input | Channels | 2 channels, 4 channels, 8 channels, 12 channels (refer to the suffix code) |
| | Input | <ul style="list-style-type: none"> ● RTD input 2 types (Pt-100, KPt-100), ● Thermocouple input 12 types (K, J, E, T, R, B, S, L, N, U, Wre 5-26, PL- II), ● DC voltage input 4 types (-10 - 20 mV, 0 - 100 mV, 1 - 5 V, 0 - 30 V) |
| | Sampling cycle | 250 ms |
| | Accuracy | ±0.15 % of FS ±1 digit(RJC temperature error excluded) |
| | RJC temperature error | ±1.5 °C (0 ~ 50 °C) |
| Alarm | Burnout function | UP-Scale during disconnection |
| | Alarm setting | 2 alarm settings per channel |
| Alarm | Alarm type | High/low limit, High/low limit within/out of range, etc. |
| | Internal memory | Non-volatile memory: 80 MB -15 days in 1 second cycle |
| Storage functions | External memory | SD card (2GB): store approx. 1 year in 1 second cycle ※ SDHC support |
| | File type | FAT 16/32 (SD card) |
| | Saving interval | User settings (1, 2, 5, 10, 20, 30, 60, 120 sec) |
| | Trend screen LIST function | Enter and display user messages on the graph |
| Display Specifications | Display | TFT color LCD (115.2 mm × 86.4 mm, 640 × 480 pixel) LED Back light |
| | Languages | Korean, English, Chinese (simplified, traditional) |
| | Screen | Horizontal trend, text view, bar graph |
| | View saved history | Select, display, zoom, reduce saved data |
| DI (option) | External digital input (DI) | 2 contacts, 4 contacts |
| | Input type | Non-voltage contact input |
| DO (option) | Contact outputs | D6 contacts, 12 contacts (NO) |
| | Contact point | 3 A 250 V a.c. (3 A 30 V d.c.) |
| Weight (g) | | 1,300 |

2~12 channels
Touch panel

2 channels
For recording
paper

Suffix code

| Model | Code | Content |
|---|--|---------------------------------|
| GR200 - | <input type="checkbox"/> <input type="checkbox"/> <input type="checkbox"/> | Touch Screen Graphic Recorder |
| Input channel | 2 | 2 channels |
| | 4 | 4 channels |
| | 8 | 8 channels |
| | 12 | 12 channels |
| External contact input/output (DI / DO) | N | None |
| | 1 | DI contacts + Relay 6 contacts |
| | 2 | DI contacts + Relay 12 contacts |
| Communication function | 0 | RS422/485 |
| | 1 | Ethernet |

GRAPHIC RECORDERS

RT9N

Specifications

| Model | RT9N |
|--------------------------------------|--|
| Appearance |  |
| W×H×D(mm) | 96.0×96.0×100.0 |
| Power voltage | 100-240 V a.c. (±10 %), 50/60 Hz |
| Power consumption | Max. 15 W, max. 20 VA |
| Sampling cycle | 250 ms |
| Input | <ul style="list-style-type: none"> ● Thermocouple : K, J, E, T, R, S, B, L, N, U, WRe 5 - 26, PL- II ● RTD : Pt 100 Ω, KSpt 100 Ω ● DC voltage : 1-5 V d.c., 0-10Vd.c., -10-20 mV d.c., 0-100 mV d.c. (freescale type) |
| Input display resolution | Basically below the decimal point of the measuring range table |
| Input impedance | Thermocouple and DC voltage input (mV): min. 1 MΩ. DC voltage input(V): approx. 1 MΩ |
| Alarm | Relay output (AL1,AL2) |
| Allowable signal source resistance | Thermocouple (max. 250 Ω). DC voltage (max. 2 kΩ) |
| Allowable wiring resistance | RTD max. 10 Ω. (but the resistance among 3 lines should be same) |
| Allowable input voltage | Within ±10 V (thermocouple,RTD,DC voltage (mV)) Within ± 20 V (DC voltage (V)). |
| Noise removal rate | NMRR (normal mode): 40 dB min , CMRR (common mode): 120 dB min (50/60 Hz ±1 %) |
| Applicable standard | Thermocouple/RTD (KS/IEC 751/DIN) |
| Reference contact compensation error | ±1.5 °C (15 ~ 35 °C 사이), ±2.0 °C (0 ~ 50 °C range) |
| Accuracy | Indication and record accuracy: ±0.5 % (Full Scale) |
| Record | <ul style="list-style-type: none"> ● Recording paper check: If there is no recording paper, the P-END lamp on the front display window lights and recording stops ● Printing method: 203 dpi (8.0 dots/mm) 384 dots per line ● Recording paper speed: (20, 30, 60, 120, 180, 300, 600, 900) mm/h ● Measurement point: 1 contact ● Response time: varies according to recording speed ● Recording method: Thermal line ● Recording paper: width 57.5 mm, length approx. 16 m |

Suffix code

| Model | Code | Content |
|--------------------|--|---|
| RT9N- | <input type="checkbox"/> <input type="checkbox"/> <input type="checkbox"/> | 2-Channel Temperature Controller/Recorder |
| Control type | 0 | Temperature recorder only |
| | 1 | Temperature recorder and controller |
| Number of channels | 1 | 1 channel |
| | 2 | 2 channel |
| Option | 0 | None (AL1 built-in) |
| | 1 | AL2 |
| | 2 | AL2, RS485 communication |
| | 3 | RS485 communication |
| | | 1-Channel type only |





Range and input code chart

| Classification | NO. | Input type | Indication Symbols | Range (°C) | Accuracy | 비고 |
|----------------------------|-----|-------------------|--------------------|--|-------------------------|--|
| Thermocouple (TC) | 1 | K | *2 \mathcal{K} | -200 ~ 1370 | ±0.5% of FS ±1 digit | ⚠ Caution <ul style="list-style-type: none"> • Measurement Input Wiring <ul style="list-style-type: none"> - Disconnect the regulator body and external supply power when wiring the measurement input lines. - Pay attention to the polarity of the input and connect the input signal between the power circuit and the ground circuit. - Please use SHIELD-treated wiring for the input and ground SHIELD to 1 point. • Digit is the minimum display <ul style="list-style-type: none"> *1) 0 ~ 400 °C range : ±10 % of F.S ±1 digit *2) Max. 0 °C : ±1.0 % of F.S ±1 digit *3) -150.0 ~ 150.0 °C range : ±1.0 % of F.S ±1 digit *4) When using current input, select code number "30" and attach a 250 Ohm 0.1% resistance to the input signal terminal. • FS from the minimum to the maximum of each range measurable range. • When selecting the input type, the selection number is set in the value display window (SV). However, do not set a number that does not have an input signal selection number. |
| | 2 | K | *2 \mathcal{K} | -199.9 ~ 999.9 | | |
| | 3 | J | *2 \mathcal{J} | -199.9 ~ 999.9 | | |
| | 4 | E | *2 \mathcal{E} | -199.9 ~ 999.9 | | |
| | 5 | T | *2 \mathcal{T} | -199.9 ~ 400.0 | | |
| | 6 | R | *2 \mathcal{r} | 0 ~ 1700 | ±0.5% of FS ±1 digit | |
| | 7 | B | *1 \mathcal{b} | 0 ~ 1800 | | |
| | 8 | S | \mathcal{S} | 0 ~ 1700 | | |
| | 9 | L | *2 \mathcal{L} | -199.9 ~ 900.0 | ±0.5% of FS ±1 digit | |
| | 10 | N | \mathcal{n} | -200 ~ 1300 | ±1.0% of FS ±1 digit | |
| | 11 | U | *2 \mathcal{U} | -199.9 ~ 400.0 | ±0.5% of FS ±1 digit | |
| | 12 | W | \mathcal{w} | 0 ~ 2300 | | |
| | 13 | Platinel II | \mathcal{PLII} | 0 ~ 1390 | ±0.5% of FS ±1 digit | |
| RTD | 20 | KSpt100 Ω | *3 \mathcal{KPI} | -199.9 ~ 500.0 | | |
| | 21 | Pt100 Ω | *3 \mathcal{PI} | -199.9 ~ 640.0 | | |
| Direct voltage (VDC/mV DC) | 30 | 1-5 V d.c. | \mathcal{dLV} | Scaling range SL-L : -1999 SL-H : 9999 | ±0.5% of FS ±1 digit | |
| | 31 | 0-10 V d.c. | \mathcal{dLV} | | | |
| | 32 | -10 - 20 m V d.c. | \mathcal{dLV} | | | |
| | 33 | 0-100 m V d.c. | \mathcal{dLV} | | | |
| Direct current | 30 | 4-20 mA d.c. | *4 \mathcal{dLV} | 4-20 mA d.c. | | |

LC series



Specifications

| Model | LC6 | LC4 | LC3 | LC7 |
|--------------------------------|---|---|---|---|
| Appearance |  |  |  |  |
| W×H×D(mm) | 72.0×36.0×84.1 | 48.0×48.0×79.5 | 96.0×48.0×71.1 | 72.0×72.0×92.9 |
| Power voltage | 100-240 V a.c. 50/60 Hz, 24-48 V a.c. 50/60 Hz or 24-48 V d.c. (Voltage fluctuation rate: ±10 %) | | | |
| Power consumption | 2-stage setting: max. 12 VA. 1-stage setting: max. 11 VA | | | |
| Character height | Counting unit (10.5 mm), Setting unit (6.7 mm) | 6-digit: counting unit (10.8 mm), setting unit (8 mm) 4- digit: counting unit (14 mm), setting unit (8.5 mm) | Counting unit (14.5 mm), Setting unit (10 mm) | Counting unit (17.2 mm), Setting unit (12.5 mm) |
| Maximum counting speed | 1 CPS / 30 CPS / 1 KCPS / 10 KCPS | | | |
| Power outage compensation | 10 years (using non-volatile memory) | | | |
| Input | <ul style="list-style-type: none"> ● Selection of input method by external switch (voltage input / non-voltage input) ● Counter : composed of CP1, CP2, RESET, BATCH-RESET ● Voltage input : HIGH level (5 - 30 V d.c.), LOW level (0 - 2 V d.c.), input resistance (about 4.5 kΩ) ● Timer : composed of START, INHIBIT, RESET ● Non-voltage input : impedance during short-circuit (max. 1 kΩ), residual voltage during short-circuit (max. 2 V d.c.) | | | |
| Minimum input signal time | 1 ms / 20 ms (START, INHIBIT, RESET inputs) | | | |
| External power supply | Max. 12 V d.c. 100 mA | | | |
| ONE SHOT output | 0.01 ~ 99.99 SEC | | | |
| Control output | Contact | 1-Stage setting | OUT (SPST, 1a) | |
| | | 2-Stage setting | OUT1 (SPST, 1a), OUT2 (SPDT, 1c) * OUT2 of LC6-P62C: SPST configuration | |
| | Capacity | SPDT: NC (250 V a.c. 5A), NO (250 V a.c. 2A) SPST: 250Va.c. 5A, resistive load | | |
| | Contactless | 1-Stage setting | NPN circuits (OUT, BAT.O) * LC4-P61C/P41C models NPN 1 circuit configuration | |
| | | 2-Stage setting | - | NPN 2 circuits (OUT1, OUT2) |
| Capacity | Open collector, 30 V d.c. 100 mA max | | | |
| Timer operation error | Power star t: max. ±0.01 % ±0.05 sec, Reset start : max. ±0.01 % ± 0.03 sec | | | |
| Communication | <ul style="list-style-type: none"> ● Protocol : Modbus-RTU ● Synchronization: Asynchronous ● Max. connections : 31 (Address:1 ~ 127) ● Start bit : 1 bit (Fixed) ● Data bit : 8 bit ● Communication speed : 2,400 / 4,800 / 9,600 / 19,200 / 38,400 bps ● Communication type : RS485 (2-Wire half-duplex) ● Effective distance : Max. within 800 m ● Response waiting time : 5 ~ 99 ms ● Stop bit : 1 bit (Fixed) ● Parity bit : None / Odd / Even | | | |
| Insulation Resistance | Min. 100 MΩ (500 V d.c.) conductive terminal - unfilled metal | | | |
| Dielectric strength | 2,000 V a.c. 60 Hz for 1 min (Different live part terminals) | | | |
| Noise immunity | Square-wave noise by noise simulator (1 μs pulse every 16 ms), ±2000 V (pulse width 1 μs) | | | |
| Vibration resistance | 10 - 55 Hz, single amplitude 0.5 mm, 3-axis each direction, 2 h | | | |
| Relay life | Electrical | Min. 50,000 times | | |
| | Mechanical | Min. 10 million times | | |
| Degree of protection | IP66 (IEC 60529) (Product front) | | | |
| Storage temperature | -20 ~ 65 °C | | | |
| Ambient temperature & humidity | -10 ~ 55 °C, 35 ~ 85 % RH (Without condensation) | | | |
| Certified |  | | | |
| Weight (g) | 196 | 140 | 143 | 222 |

New product
Count/Timer

Small LCD
counter

Digital
Counter/Timer

New product
Timer

Small LCD
Timer

Digital
Twin Timer

Digital
Timer

Weekly/yearly
Time switch

Timing
Relay

Analog
ON-Delay
Timer

Analog
Twin/Dual
Timer

Analog
Multi
Timer

Star-delta
Timer

Suffix code

| Model | Code | Content |
|----------------|---|---------------------------------------|
| LC | <input type="checkbox"/> <input type="checkbox"/> <input type="checkbox"/> <input type="checkbox"/> <input type="checkbox"/> <input type="checkbox"/> | LCD Counter / Timer |
| Appearance | 3 | 96(W) × 48(H) mm |
| | 4 | 48(W) × 48(H) mm |
| | 6 | 72(W) × 36(H) mm |
| | 7 | 72(W) × 72(H) mm |
| Type | P | Preset Counter / Timer |
| Display digits | 4 | 4 Digit display (9999) ※ LC4 only |
| | 6 | 6 digit display (999999) |
| Setting stages | 1 | 1 Stage setting |
| | 2 | 2 Stage setting |
| Sub output | N | No sub output |
| | C | RS485 (MODBUS-RTU) |
| Power voltage | A | 100-240 V a.c. 50/60 Hz |
| | D | 24-48 V a.c. 50/60 Hz or 24-48 V d.c. |

DIGITAL COUNTER/TIMERS

LC1 CE

Specifications







| Model | | LC1 | LC1-F |
|--------------------------------|----------------------|--|---|
| Appearance | |  | |
| W×H×D(mm) | | 48.0×24.0×54.0 | |
| Input type | | Non-voltage input | Voltage input |
| Power voltage | | Lithium battery built-in | |
| Input operation | | Up Count | |
| Counting speed | | 1/30/100/ 1K cps | 20 cps |
| Input conditions | | <ul style="list-style-type: none"> ● Residual voltage when it breaks : 0.7 V ● Max. impedance when it breaks: max. 10 kΩ ● Min impedance when it opens: min. 1 MΩ | <ul style="list-style-type: none"> ● HIGH : 24 - 240V a.c. / 6 - 240 V d.c. ● LOW : 0 - 2 V a.c./DC |
| Reset | Input type | Non-voltage input | |
| | Minimum signal width | Min. 20 ms | |
| Battery life | | More than 7 years (approx. 25 °C) ※ this is calculated value so it is not certified value (replacing cycle reference value) | |
| External setting switch | | <ul style="list-style-type: none"> ● SW1 : Internal battery ON/OFF, front reset key selectable ● SW2 : Count speed selectable | SW1 : Internal battery ON/OFF, front reset key selectable |
| External connection | | Terminal Blocks (4P) | |
| Display method | | 7 Segment LCD (character height: 8.7 mm) | |
| Display digits | | 8 Digits | |
| Insulation resistance | | Min. 100 MΩ (500 V d.c), conductive terminal - unfilled metal | |
| Dielectric strength | | 2000 V a.c. 50/60 Hz for 1 min (conductive terminal - unfilled metal) | |
| Vibration resistance | | 10 - 55 Hz, Double amplitude 0.75 mm, 3 axes each direction, 2h | |
| Shock resistance | | 300 m/s, 3 Axes each direction each 3 times | |
| Ambient temperature & humidity | | -10 ~ 55 °C / 35 ~ 85 % RH (Without condensation) | |
| Storage temperature | | -25 ~ 65 °C | |
| Degree of protection | | IP66 (IEC 60529) (Front side) | |
| Weight (g) | | 58 | |

Suffix code

| Model | Code | Content |
|--------------|------|---|
| LC1 | □ | Compact LCD Total Counter |
| Input signal | | Non-voltage input |
| | F | Voltage input (24-240 V a.c. 50/60 Hz / 6-240 V d.c.) |

GF series

Specifications

| Model | | GF7-P62 / GF7-P42 | GF7-P61 / GF7-P41 | GF7-T60 | GF4-P41 | GF4-P40 | GF4-P41S |
|--------------------------------|---|--|--|---|---|---|---|
| Appearance | |  |  |  |  |  |  |
| W×H×D(mm) | | 72.0×72.0×112.0 | | | 48.0×48.0×90.8 | | 48.0×48.0×71.8 |
| Input | Input count speed | 30 cps, 1K, 3K, 5K cps (Selection by front volume) | | | 30 cps, 5K cps (Selection by side dip switch) | | |
| | | When ON / OFF ratio is 1: 1 | | | | | |
| | Input signal method | PNP input (voltage input) or NPN input (non-voltage input) selection [HIGH] level 5 - 30 V d.c. [LOW] level 0 - 2 V d.c. | | | | | |
| | Inhibit input | Counting stops when signal is "ON" (min. 20 ms) | | | | | |
| | Reset | Power reset (0.5 s min), external reset (min. 20 ms), automatic reset | | | | | |
| Performance | Noise immunity | Square wave noise by noise simulator (1μs pulse width), ±2 kV (between operation power terminals) | | | | | |
| | Timer | Setting error | ● Max. ±0.01% ±0.05 sec (when the power is START) | | | | |
| | | Repetition error | ● Max. ±0.005% ±0.003 sec (when START is by RESET) | | | | |
| | Insulation Resistance | Min. 100 MΩ (500 V d.c. Mega, conductive terminal - exposed unfilled metal part) | | | | | |
| Dielectric strength | 2000 V a.c. 60 Hz for 1 min (conductive terminal - exposed unfilled metal part) | | | | | | |
| Function and output | Counter/Timer selection | Counter operation, timer operation selection | | | | | |
| | Input operation | Addition, subtraction, addition/subtraction selection (refer to input operating mode) | | | | | |
| | Output operation (Counter) | F, N, C, R, K, P, Q, S, A selection (refer to output operating mode) ※ For the total counter, it is displayed as F, K output mode | | | | | |
| | Output method | ON Delay and OFF Delay selection by dip switch | | | | | |
| | OUT1 Function selection | Hold, One-shot, Flicking (Every second) function selection (For 2-stage setting only) | | | | | |
| | Prescale | Preset counter only, 0.001 ~ 9999 (4 Digits), 0.00001 ~ 999999 (6 Digits) | | | | | |
| | Count value change | Constant recognition (setting can be changed during operation) | | | | | |
| | Power outage compensation selection | Power outage compensation / power reset selection, semi-permanent when selecting power outage compensation (EEPROM usage) | | | | | |
| | Number of digits | 4 Digits / 6 Digits | | 6 Digits (999999) | | 4 Digits (9999) | |
| | Decimal point display | 4 Digits : 888.8 / 8888, 6 Digits : 888888 / 88888.8 / 8888.88 / 888.888 | | | | | |
| | Setting Stages | 1-Stage / 2-Stage | | None | | 1-Stage / None / 1-Stage | |
| | ONE SHOT output | 0.05 Sec - 5.8 Sec (Setting by front TM volume) | | | 0.1 ~ 12.5 Sec (Setting by front TM volume) | | |
| | External power supply | Max.12 V d.c. 100 mA | | | Max.12 V d.c. 100 mA | | |
| | Character display | Height : 11 mm (4 Digits), Height : 10 mm (6 Digits) | | | Height : 8 mm | | |
| | Control output | Contact | OUT1/OUT2 (OUT) : SPDT (1c), 250 V a.c. 3A, Resistor installation (For 1-stage output, only OUT output is available) * GF4-P41S : SPST (1a) configuration | | | | |
| Contactless | | OUT1/OUT2 (OUT): Open collector, 30 V d.c., 100 mA max. (For 1-stage output, only OUT output is available) | | | | | |
| Power voltage | 100 - 240 V a.c. 50/60 Hz | | | | | | |
| Voltage fluctuation rate | ±10 % of power voltage | | | | | | |
| Power consumption | GF7-P61 : Approx. 7.6 VA GF7-P62 : Approx. 8.7 VA | | Approx. 6.4 VA | | Approx. 6.2 VA | | |
| Ambient temperature & humidity | -10 ~ 55 °C, 35 ~ 85 % RH (Without condensation) | | | | | | |
| Storage temperature | -20 ~ 65 °C | | | | | | |
| Vibration resistance | 10 - 55 Hz, Double amplitude 0.75 mm, 3 axes each direction, 1 h | | | | | | |
| Shock resistance | 300 m/s ² , 3 axes each direction 3 times | | | | | | |
| Weight (g) | 243 | | 208 | | 184 | | |

New product
Count/Timer

Small LCD
counter

Digital
Counter/Timer

New product
Timer

Small LCD
Timer

Digital
Twin Timer

Digital
Timer

Weekly/yearly
Time switch

Timing
Relay

Analog
ON-Delay
Timer

Analog
Twin/Dual
Timer

Analog
Multi
Timer

Star-delta
Timer

Suffix code

GF7

| Model | Code | Content |
|-------------------|---|---|
| GF7- | <input type="checkbox"/> <input type="checkbox"/> <input type="checkbox"/> <input type="checkbox"/> | Digital Counter / Timer |
| Type | P | Preset method |
| | T | Indication only |
| Display digits | 4 | 4 Digit display (9999) |
| | 6 | 6 Digit display (999999) |
| Setting stages | 2 | 2-Stage setting |
| | 1 | 1-Stage setting |
| | 0 | Total counter |
| Prescale function | E | Prescale function built-in (preset counter) |
| | N | Prescale None (Total counter) |

GF4



| Model | Code | Content |
|-------------------|---|-----------------------------------|
| GF4- | <input type="checkbox"/> <input type="checkbox"/> <input type="checkbox"/> <input type="checkbox"/> | Digital Counter / Timer |
| Type | P | Preset method |
| | T | Indication only |
| Display digits | 4 | 4 Digit display (9999) |
| Setting stages | 1 | 1-Stage setting (Preset counter) |
| | 0 | None (Total counter) |
| | N | Terminal block |
| Prescale function | S | 8-Pin socket * GF4-P41S available |

DIGITAL COUNTER/TIMERS

LT4 series



Specifications

| Model | | LT4 (Socket type) | LT4S (Socket type) |
|------------------------------------|-----------------------|--|--|
| Appearance | |  |  |
| W×H×D(mm) | | 48.0×48.0×65.7 | |
| Power voltage | | 24-240 V a.c. 50/60 Hz, 24-240 V d.c. Combined | |
| Allowable voltage fluctuation rate | | ±10% of power voltage | |
| Power consumption | | Max. 4 VA (24 - 240 V a.c. 50/60 Hz) Max. 1.6 W (24 - 240 V d.c.) | Max. 4.5 VA (24 - 240 V a.c. 50/60 Hz) Max. 2 W (24 - 240 V d.c.) |
| Display method | | Wide viewing angle negative LCD display | |
| Display mode | | Up display and down display | |
| Display digits | | 4 Digits | |
| Character height | | PV display : 14mm, SV display : 8.5mm | |
| Return time | | Max. 100 ms | |
| External connection | | Socket 8-pin | |
| Operating time range | | 0.01 sec ~ 9999 hour | |
| External input | Input signal | - | START, INHIBIT, RESET |
| | Input method | - | <ul style="list-style-type: none"> ● Non-voltage input ● Impedance during short-circuit: max. 1 kΩ ● Voltage during short-circuit: max. 0.5 V ● Impedance during open: min. 100 kΩ |
| Minimum input time | | - | START, INHIBIT, RESET minimum input signal width 1 ms / 20ms selection |
| Operating time error | | Power START : max. ± 0.01 % ±0.05 sec., Signal START : max. ± 0.005 % ±0.03 sec. | |
| Control output | Operation mode | POND / PFKF / PFKN / PINT / TWON / TWOF / S-D | SOND / SFKF / SINT / SNFN / SNFF / SOFD / S.OND / S.FKN / S.INT / S.ODR |
| | Contact configuration | Time limit 2c, instantaneous 1c + time limit 1c | Time limit 1c |
| | Contact capacity | 250 V a.c. 3A resistive load (NO : 5A, NC : 3A) | 250 V a.c. 5A resistive load |
| Relay life | | <ul style="list-style-type: none"> ● Mechanical life: min. 10 million times ● Electrical life: min. 100,000 times (250 V a.c. 5A resistive load) | |
| Insulation Resistance | | Min. 100 MΩ (500 V d.c. Mega standard, conductive terminal - exposed unfilled metal part) | |
| Dielectric strength | | 2000 V a.c. 60 Hz for 1 min (Conductive terminal - exposed unfilled metal part) | |
| Noise immunity | | ± 2 kV (among operation power terminals, pulse width = 1 us, square wave noise by noise simulator) | |
| Vibration resistance | | 10 - 55 Hz (for 1 min) single amplitude 0.5 mm X, Y, Z each direction 2 hours | |
| Shock resistance | | 300 m/s ² (30G) X, Y, Z Each direction 3 times | |
| Degree of protection | | IP66 (IEC 60529) (Product front) | |
| Ambient temperature & humidity | | -10 ~ 55 °C, 35 ~ 85 % RH (However, there will be no condensation.) | |
| Storage temperature | | -25 ~ 65 °C | |
| Certified | |  | |
| Weight (g) | | 86 | 84 |

Suffix code

| Model | Code | Content |
|----------------|------|---|
| LT4 | □ | LCD Timer |
| Control output | | Time limit 2c, time limit 1c + instantaneous 1c |
| | S | Time limit 1c |

LT1

Specifications

| Model | | LT1 | LT1-F |
|--------------------------------|----------------------|---|---|
| Appearance | |  | |
| W×H×D(mm) | | 48.0×24.0×54.0 | |
| Input type | | Non-voltage input | Voltage input |
| Power voltage | | Lithium battery built-in | |
| Operation type | | UP Timer | |
| Time display | | 9999 h 59 m 59 s / 99999 h 59.9 m / 999999 h 59 m / 9999999.9 h | |
| Time accuracy | | ± 0.01 % | |
| Input conditions | | <ul style="list-style-type: none"> ● Residual voltage when breaks : 0.7 V ● Max. impedance when breaks: max. 10 kΩ ● Min impedance when opens: min. 1 MΩ | <ul style="list-style-type: none"> ● HIGH : 24-240 V a.c./6-240 V d.c. ● L OW : 0-2 V a.c./0-2.4 V d.c. |
| Start input | Input type | Non-voltage input | Voltage input |
| | Minimum signal width | Min. 20 ms | |
| Reset input | Input type | Non-voltage input | |
| | Min signal width | Min. 20 ms | |
| Battery life | | More than 10 years (approx. 25 °C) ※ This is calculated value so it is not certified value (Replacing cycle reference value) | |
| External setting switch | | ●SW1 : Internal battery ON/OFF, front reset key selectable ●SW2 : Time range selection | |
| External connection | | Terminal Blocks (4P) | |
| Display method | | 7 Segment LCD (Character height : 8.7 mm) | |
| Display digits | | 8 Digits | |
| Insulation resistance | | Min. 100 MΩ (500 V d.c.) conductive terminal - unfilled metal | |
| Dielectric strength | | 2000 V a.c. 50/60 Hz for 1 min (Conductive terminal - unfilled metal) | |
| Vibration resistance | | 10 - 55 Hz, double amplitude 0.75 mm, 3 axes each direction, 2h | |
| Shock resistance | | 300 m/s ² , 3 axes each direction each 3 times | |
| Ambient temperature & humidity | | -10 ~ 55 °C / 35 ~ 85 % RH (Without condensation) | |
| Storage temperature | | -20 ~ 65 °C | |
| Degree of protection | | IP66 (IEC 60529) (Front side) | |
| Weight (g) | | 58 | |

New product
Count/Timer

Small LCD
counter

Digital
Counter/Timer

New product
Timer

Small LCD
Timer

Digital
Twin Timer

Digital
Timer

Weekly/yearly
Time switch

Timing
Relay

Analog
ON-Delay
Timer

Analog
Twin/Dual
Timer

Analog
Multi
Timer

Star-delta
Timer



Suffix code

| Model | Code | Content |
|--------------|------|--|
| LT1 | □ | Compact LCD Indicating Total Timer |
| Input signal | | Non-voltage input (no display) |
| | F | Voltage input (24-240 V a.c. / 6-240 V d.c.) |

DIGITAL COUNTER/TIMERS

TT SERIES

Specifications

| Model | | TT7H | TT4-P42A | TT4-P42B |
|------------------------------------|-----------------------|---|--|---|
| Appearance | |  |  |  |
| W×H×D(mm) | | 72.0×72.0×63.0 | 48.0×48.0×87.0 | 48.0×48.0×87.0 |
| Power voltage | | 220 V a.c. 60Hz | 100-240 V a.c. 50/60 Hz | |
| Allowable voltage fluctuation rate | | ±10% of power voltage | | |
| Power consumption | | Approx. 9.6 VA (with 220 V a.c. 60 Hz) | Max. 9.1 VA (220 V a.c. 60 Hz) | |
| Display method | | ON Time display window: Red FND 4 digits (Character height: 18.7 mm) OFF Time display window: Red FND 4 digits (Character height: 14.5 mm) | PV : Character height 11 mm, SV : Character height 8 mm | |
| External connection method | | Terminal | 11-Pin socket | 8-Pin socket |
| Minimum signal time | | START: min. 1s | START: min. 20 ms (RST / INH) | - |
| Control output | Contact configuration | Output: time limit SPDT (1c) | | |
| | Contact capacity | ● NO : 250 V a.c. 5 A (Resistive load) ● NC : 250 V a.c. 2 A (Resistive load) | | |
| Relay life | Mechanical | Min. 10 million times | | |
| | Electrical | Min. 100,000 times (250 V a.c. 3A resistive load) | | |
| Dielectric strength | | 2,000 V a.c. 50/60 Hz for 1 min | | |
| Noise immunity | | ±2 kV (Between operation power terminals), square wave noise by noise simulator (pulse width = 1 μs) | | |
| Insulation Resistance | | Insulation Resistance | | |
| Vibration resistance | | 10 - 55 Hz (1 Minute cycle), peak amplitude 0.75 mm X·Y·Z each direction 1 hour | | |
| Shock resistance | | 300 m/s ² , X·Y·Z each direction 3 times | | |
| Ambient temperature & humidity | | -10 ~ 55 °C, 30 ~ 85 % RH (without condensation) | | |
| Storage temperature | | -20 ~ 65 °C | | |
| Weight (g) | | 300 | 108 | |

Suffix code

TT7H

| Model | Code | Content |
|---------------------|---|--------------------------------------|
| TT7H- | <input type="checkbox"/> <input type="checkbox"/> <input type="checkbox"/> <input type="checkbox"/> | Digital Twin Timer |
| Settings | P | Preset method |
| Display digits | 4 | 4 Digit display (9999) |
| Control output | 1 | 1-Stage output |
| External connection | A | 9-Pin terminal type (external input) |

TT4

| Model | Code | Content |
|---------------------|---|------------------------|
| TT4 | <input type="checkbox"/> <input type="checkbox"/> <input type="checkbox"/> <input type="checkbox"/> | Digital Dual Timer |
| Settings | P | Preset method |
| Display digits | 4 | 4 Digit display (9999) |
| Control output | 2 | 2-Stage output |
| External connection | A | 11-Pin socket type |
| | B | 8-Pin socket type |

TF4

Specifications

| Model | | TF4-A | TF4-B | TF4-C |
|--------------------------------|--------------------------|---|--|-------|
| Appearance | |  | | |
| W×H×D (mm) | | 48.0×48.0×72.0 | | |
| Input | Reset | Power reset (min. 500 ms), external reset and manual reset (min. 20 ms) | | |
| | Inhibit input | Measurement time stop by external signal (min. 20 ms) | | |
| | Noise immunity | Square wave noise by noise simulator (1 μs pulse width), ± 2 kV (between operation power terminals) | | |
| Performance | Repetition accuracy | Max. ±0.01 % ±0.05 sec of set value (when the power is START) | | |
| | | Max. ±0.005 % ±0.003 sec of set value (if start by reset) | | |
| | Insulation resistance | Min. 100 MΩ (500 V d.c.) conductive terminal - unfilled metal | | |
| | Dielectric strength | 2,000 V a.c. 60 Hz for 1 min (Different live part terminals) | | |
| Function and output | Operation type | | Up display, down display (selection by suffix code) | |
| | Output operation | | Present value becomes "ON" when the set value is matched (addition) Present value becomes "ON" when it becomes "0" from the set value (subtraction) ※ refer to output operating mode | |
| | Time setting recognition | | Constant recognition (setting can be changed even during energization) | |
| | Character display | | Height 11 mm, width 8 mm | |
| | Control output | Relay | Time limit 1 c, 250 V a.c. 3 A (resistive load) | |
| | | Transistor | Open collector, max. 30 V d.c. 100 mA | |
| Time range | | A: 999.9 sec / 9999 sec, B: 9 min 59.9 sec / 59 min 59 sec, C: 999.9 min / 59 hours 59 min | | |
| Power voltage | | 100-240 V a.c. 50/60 Hz, 24-60 V d.c. | | |
| Voltage fluctuation rate | | ±10% of power voltage | | |
| Power consumption | | ● AC : approx. 4.8 VA (240 V a.c. 60 Hz), ● DC : approx. 0.7 W (24 V d.c.) | | |
| Ambient temperature & humidity | | -10 ~ 50 °C 35 ~ 85 % RH (Without condensation) | | |
| Storage temperature | | -20 ~ 65 °C | | |
| Vibration resistance | | 10 - 55 Hz, single amplitude 0.5 mm, 3 axes each direction, 2 h | | |
| Shock resistance | | 300 m/s ² , 3 axes each direction each 3 times | | |
| Weight (g) | | 100 | | |

| |
|---------------------------|
| New product Count/Timer |
| Small LCD counter |
| Digital Counter/Timer |
| New product Timer |
| Small LCD Timer |
| Digital Twin Timer |
| Digital Timer |
| Weekly/yearly Time switch |
| Timing Relay |
| Analog ON-Delay Timer |
| Analog Twin/Dual Timer |
| Analog Multi Timer |
| Star-delta Timer |

Suffix code

| Model | Code | Content |
|---------------------|---|--------------------------------|
| TF4- | <input type="checkbox"/> <input type="checkbox"/> <input type="checkbox"/> <input type="checkbox"/> | Digital Timer 48(W) X 48(H) |
| Time Specifications | A | 999.9 sec / 9999 sec |
| | B | 9 min 59.9 sec / 59 min 59 sec |
| | C | 999.9 min / 59 hours 59 min |
| Display method | U | Up display |
| | D | Down display |
| Power voltage | A | 100-240 V a.c. 50/60 Hz |
| | D | 24-60 V d.c. |
| Control output | R | Relay |
| | T | Open collector |

DIGITAL COUNTER/TIMERS

LF4N CE

Specifications



| Model | | LF4N-A | LF4N-B | LF4N-C | LF4N-D |
|--------------------------------|-----------------------|--|---------------------------------|-------------------|----------------|
| Appearance | |  | | | |
| W×H×D(mm) | | 48.0×48.0×69.5 | | | |
| Input | Input signal | Reset, start, inhibit. ✖ LF4N-A and LF4N-D only. | | | |
| | Non-voltage input | Paragraph level (during transistor ON): residual voltage max. 0.7 V d.c., impedance max. 2 kΩ | | | |
| | Contact input | Open level (during transistor OFF): impedance min. 100 kΩ Use a contact that can open and close 5 V d.c., 2 μA sufficiently | | | |
| Performance | Repetition accuracy | ● Max. ±0.01 % ±0.05 s of set value (power start), ● Max. ±0.005 % ±0.03 s of set value (start signal) | | | |
| | Return time | Max. 0.1 s | | | |
| | Noise immunity | Square wave noise by noise simulator (1 μs pulse width), ±2 kV (between operation power terminals) | | | |
| | Insulation resistance | Min. 100 MΩ (500 V d.c.) conductive terminal - unfilled metal | | | |
| | Dielectric strength | 2000 V a.c. 60 Hz for 1 min (different live part terminals) | | | |
| Function and output | Output operation mode | Operating mode 10 types (selection by front digital switch) but LF4N-B, LF4N-C (A mode: POWER ON delay fixed) | | | |
| | Time display method | Set by internal UP / Down selection switch | | | |
| | Time range | Time range 10 types (selection by front digital switch) | | | |
| | Set value recognition | Constant recognition (setting can be changed even during energization) | | | |
| | Control output | SPDT (1c), 250 V a.c. 3A, resistive load | | | |
| | | Time limit 1c | Time limit 1c, instantaneous 1c | Time limit 1c × 2 | Time limit 1c |
| Applicable socket | 8-Pin socket | | | 11-Pin socket | |
| Power voltage | | 24-240 V a.c. 50/60 Hz or 24-240 V d.c. (Universal) | | | |
| Voltage fluctuation rate | | ±10% of power voltage | | | |
| Power consumption | 240Va.c. | Approx. 2.5 VA | Approx. 2.9 VA | Approx. 2.5 VA | Approx. 2.5 VA |
| | 240Vd.c. | Approx. 1.5 W | Approx. 2.1 W | Approx. 1.5 W | Approx. 1.5 W |
| Ambient temperature & humidity | | -10 ~ 55 °C, 35 ~ 85 % RH (Without condensation) | | | |
| Storage temperature | | -20 ~ 65 °C | | | |
| Vibration resistance | | 10 - 55 Hz, Double amplitude 0.75 mm, 3 axes each direction, 2 h | | | |
| Shock resistance | | 300 m/s ² , 3 axes each direction each 3 times | | | |
| Weight (g) | | 80 | 86 | | 82 |

Suffix code

| Model | Code | Content | | |
|-----------------|------|--|--------------------------------|--------------------|
| LF4N- | □ | LCD Timer | | |
| Types selection | A | Time limit 1c | Operating mode (10 types) | 8-Pin socket type |
| | B | Time limit 1c, instantaneous 1c | ON delay output (A mode fixed) | |
| | C | Time limit 2c | | |
| | D | Time limit 1c | Operating mode (10 types) | 11-Pin socket type |
| Power voltage | | 24-240 V a.c. 50/60 Hz or 24-240 V d.c. (Common) | | |

LY series

Specifications

| Model | | LY4 | LY7 |
|--|----------------------------|--|--|
| Appearance | |  |  |
| W×H×D(mm) | | 48.0×48.0×59.8 | 72.0×72.0×56.0 |
| Power voltage | | 100-240 V a.c. 50/60Hz (Universal) | |
| Allowable voltage fluctuation rate | | ±10 % of power voltage | |
| Power consumption | | Approx. 2.6 VA(220 V a.c. 60Hz) | Approx. 4.2 VA (220 V a.c.. 60 Hz) |
| Display method | | LCD Display method (display digits: 4 digits 2 lines) 1st display: character height 7.8 mm, 2nd display: character height 5.2 mm | LLCD Display method (Display digits: 4 digits 2 lines) 1st display: character height 12 mm, 2nd display: character height 7 mm |
| 1 cycle time | | ● During weekly setting: 1 week (7 Days) ● Yearly setting: for 1 year (Calendar until 2099 built-in) | |
| Power outage compensation time | | More than 5 consecutive years (25°C) | |
| Setting steps | Number of program steps | Weekly program: 64 steps, yearly program: 32 Steps | |
| | Number of season settings | 4 Seasons (Spring, Summer, Fall, Winter) | |
| | Number of holiday settings | 16 Times | |
| Installation structure (external connection) | | Flush panel mount type, and exposed panel mount type (dual usage) Din rail installation and screw fixing | |
| Cycle error | | ±15 Sec/month (25°C) | |
| Time error | | ±0.01% max. ±0.05 sec (setting error, voltage error, temperature error) | |
| Control output | Contact configuration | OUT : SPST (1a) | 2 Independent circuits. OUT1 : SPDT (1c), OUT2 : SPDT (1c) |
| | Contact capacity | 15 A 250 V a.c. (Resistive load) | |
| | Mechanical life | Min. 10 million times | |
| | Electrical life | Min. 50,000 times (250 V a.c. 15 A resistive load) | |
| Insulation Resistance | | Min. 100 MΩ (500 V d.c. Mega standard, conductive terminal - exposed unfilled metal part) | |
| Dielectric strength | | 2000 V a.c. 50/60 Hz for 1 min (Conductive terminal - exposed unfilled metal part) | |
| Noise immunity | | ±2 kV(Among operation power terminals), square wave noise by noise simulator (pulse width= 1 μs) | |
| Vibration resistance | | 10 - 55 Hz (1 minute cycle) double amplitude 0.75 mm X·Y·Z each direction 1 hour | |
| Shock resistance | | 300 m/s ² X·Y·Z each direction 3 times | |
| Ambient temperature & humidity | | -10 ~ 55 °C, 35 ~ 85 % RH (without condensation) | |
| Storage temperature | | -20 ~ 65 °C | |
| Weight (g) | | 100 | 275 |

Suffix code

| Model | Code | Content |
|---------------|--------------------------|---------------------------------|
| LY- | <input type="checkbox"/> | LCD Weekly, Yearly Time Switch |
| Appearance | 4 | 48(W) X 48(H) mm |
| | 7 | 72(W) X 72(H) mm |
| Power voltage | | 100-240 V a.c. 50/60 Hz(Common) |

New product
Count/Timer

Small LCD
counter

Digital
Counter/Timer

New product
Timer

Small LCD
Timer

Digital
Twin Timer

Digital
Timer

Weekly/yearly
Time switch

Timing
Relay

Analog
ON-Delay
Timer

Analog
Twin/Dual
Timer

Analog
Multi
Timer

Star-delta
Timer

ANALOG TIMERS

T21

Specifications

| | | |
|------------------------------------|-----------------------|--|
| Model | AC | T21 - 1 / 3 / 6 / 3H - 4A20 |
| | DC | T21 - 1 / 3 / 6 / 3H - 4D24 |
| Appearance | |  |
| Power voltage | AC | 100-120 V a.c. 50/60 Hz, 200-230 V a.c. 50/60 Hz |
| | DC | 24 V d.c. |
| Allowable voltage fluctuation rate | | ±10% of power voltage |
| Power consumption | AC | Max. 3.1 VA (230 V a.c. 60 Hz) |
| | DC | Max. 1.5 W (24 V d.c.) |
| Return time | | Max. 100 ms |
| Time range | 1 | 0.1 sec ~ 10 min |
| | 3 | 0.3 sec ~ 30 min |
| | 6 | 0.6 sec ~ 60 min |
| | 3H | 0.3 hrs ~ 24 hrs |
| Time error (Repetition error) | | ±1 % max. (ratio of maximum scale) |
| Time error (Setting error) | | ±10 % max. (ratio of maximum scale) |
| Control output | Operation mode | Power ON delay, interval, flicker OFF start, flicker ON start |
| | Contact configuration | 4a4b |
| | Contact capacity | 240 V a.c. 3A Resistive load |
| Relay life | | ● Mechanical life : min. 10 million times, ● Electrical life : min. 100,000 times |
| Insulation resistance | | Min. 100 MΩ (500 V d.c. standard, conductive terminal - exposed unfilled metal part) |
| Dielectric strength | | 2000 V a.c. 50/60 Hz for 1 min (conductive terminal - exposed unfilled metal part) |
| Noise immunity | | ±2 kV (among operation power terminals, Pulse width ±1 μs, square wave noise by noise simulator) |
| Vibration resistance | | 10 - 55 Hz (For 1 min) double amplitude 0.75 mm X·Y·Z each direction 1 hour |
| Shock resistance | | 300 m/s ² X·Y·Z each direction 3 times |
| Ambient temperature & humidity | | - 10 ~ 50 °C, 35 ~ 85 % RH (Without condensation) |
| Storage temperature | | - 25 ~ 65 °C |
| Weight (g) | | 42 |



Suffix code

| Model | Code | Content |
|-----------------------|--|------------------------------|
| T21- | <input type="checkbox"/> <input type="checkbox"/> <input type="checkbox"/> | Timing Relay |
| Time range | 1 | 1 sec, 10 sec, 1 min, 10 min |
| | 3 | 3 sec, 30 sec, 3 min, 30 min |
| | 6 | 6 sec, 60 sec, 6 min, 60 min |
| | 3H | 3 hrs, 6 hrs, 12 hrs, 24 hrs |
| Contact configuration | 4 | 4a4b |
| Power voltage | A20 | 200-230 V a.c. |
| | D24 | 24 V d.c. |
| | A10 | 100-120 V a.c. |

Selection by side dip switch

T38N, T48N, T57N CE

Specifications

| Model | Exposed type | T38N | T48N | T57NE |
|--------------------------------|-----------------------|---|--|--|
| | Panel type | | | T57NP |
| Appearance | |  |  |  |
| W×H×D (mm) | | 40.5×50.5×74.0 | 48.0×48.0×78.7 | <ul style="list-style-type: none"> Exposed type : 50.0×70.0×86.2 Panel type : 57.5×84.4×83.7 |
| Functions | | Power On Delay Timer | | |
| Power voltage | | 24-240 V a.c. 50/60 Hz, 24-240 V d.c., 12Vd.c. (Order-made for T48N) | | |
| Voltage fluctuation rate | | ±10 % of power voltage | | |
| Power consumption | | Max. approx. 4.5 VA (240 V a.c. 60 Hz) ● Max. approx. 1.5 W (24 V d.c.) | | |
| Return time | | Max. 100 ms | | |
| Time range | 01 | 0.01 ~ 1 s / 0.01 ~ 1 m / 0.01 ~ 1 h | | |
| | 03 | 0.01 ~ 3 s / 0.01 ~ 3 m / 0.01 ~ 3 h | | |
| | 06 | 0.01 ~ 6 s / 0.01 ~ 6 m / 0.01 ~ 6 h | | |
| | 10 | 0.01 ~ 10 s / 0.01 ~ 10 m / 0.01 ~ 10 h | | |
| | 30 | 0.01 ~ 30 s / 0.01 ~ 30 m / 0.01 ~ 30 h | | |
| | 60 | 0.01 ~ 60 s / 0.01 ~ 60 m / 0.01 ~ 60 h | | |
| | 12H | 0.01 ~ 12 h / 0.01 ~ 24 h / 0.01 ~ 48 h ('24h' and '48h' time setting '12h' : 'x2' and 'x4') | | |
| Time error | Repeating error | Max. ±0.3 % (ratio of maximum scale) | | |
| | Setting error | Max. ±5 % (ratio of maximum scale) | | |
| Control output | Output mode | POWER ON DELAY | | |
| | Contact configuration | A output (time limit 1c + instantaneous 1a) / B output (time limit 1c + instantaneous 1c) / C output (time limit 2c) | | |
| | Contact capacity | 250 V a.c. 3 A (Resistive load) | | |
| Relay life | | <ul style="list-style-type: none"> Mechanical life : min. 10 million times Electrical life : min. 100,000 times | | |
| Dielectric strength | | 2,000 V a.c. 50/60 Hz For 1 min | | |
| Noise immunity | | ±2 kV (among operation power terminals), square wave noise by noise simulator (pulse width:1 μs) | | |
| Insulation resistance | | Min. 100 MΩ (500 V d.c. Mega standard) | | |
| Vibration resistance | | 10 - 55 Hz (For 1 min) double amplitude 0.5 mm X·Y·Z each direction 2 hours | | |
| Shock resistance | | 300 m/s ² (30 G) X·Y·Z each direction 3 times | | |
| Ambient temperature & humidity | | -10 ~ 55 °C, 30 ~ 85 % RH (Without condensation) | | |
| Storage temperature | | -25 ~ 65 °C | | |
| Weight (g) | | 150 | | |

Suffix code

| Model | Code | | | | | Content |
|------------------------------|------|----|---|---|---|---|
| Appearance | □- | □ | □ | □ | □ | Analog Timer |
| | T38N | | | | | 40(W) X 50(H) mm |
| | T48N | | | | | 48(W) X 48(H) mm |
| | T57N | | | | | 58(W) X 84(H) mm |
| Installation structure | P | | | | | Panel type (T38N panel adapter sold separately) |
| | E | | | | | Exposed type (select with T48N panel type) |
| Range (Dip switch selection) | | 01 | | | | 1 sec, 1 min, 1 hour |
| | | 03 | | | | 3 sec, 3 min, 3 hour |
| | | 06 | | | | 6 sec, 6 min, 6 hour |
| | | 10 | | | | 10 sec, 10 min, 10 hour |
| | | 30 | | | | 30 sec, 30 min, 30 hour |
| | | 60 | | | | 60 sec, 60 min, 60 hour |
| | | 12 | | | | 12 hour, 24 hour, 48 hour |
| Control output | | A | | | | Time limit: 1c contact, instantaneous: 1a contact |
| | | B | | | | Time limit: 1c contact, instantaneous: 1c contact |
| | | C | | | | Time limit 2c contact |
| Power voltage | | | | | | 24-240 V a.c. 50/60 Hz or 24-240 V d.c. (Common) |
| | | 12 | | | | 12 V d.c. (Only for T48N, order-made) |
| Output operation | | | | | | On-Delay |
| | | S | | | | Interval (Order-made) |



※ The installation type is only applied to the T57N, TF62N and TF62D (T38N model requires the separate purchase of panel adapter)

New product Count/Timer
Small LCD counter
Digital Counter/Timer
New product Timer
Small LCD Timer
Digital Twin Timer
Digital Timer
Weekly/yearly Time switch
Timing Relay
Analog ON-Delay Timer
Analog Twin/Dual Timer
Analog Multi Timer
Star-delta Timer

ANALOG TIMERS

TF62N/62D

Specifications

| Model | Exposed type | TF62NE | TF62DE |
|--------------------------------|---|---|--|
| | Panel type | TF62NP | TF62DP |
| Appearance |  | |  |
| W×H×D (mm) | <ul style="list-style-type: none"> Exposed type : 50.0×62.0×91.2 Panel type : 57.5×84.5×83.7 | | <ul style="list-style-type: none"> Exposed type : 50.0×77.0×91.2 Panel type : 57.5×84.4×83.7 |
| Functions | Twin timer | | Dual timer |
| Power voltage | 24-240 V a.c. 50/60Hz or 24-240 V d.c. (Common) | | |
| Voltage fluctuation rate | ±10 % of power voltage | | |
| Power consumption | <ul style="list-style-type: none"> Max. approx. 4.5 VA (240 V a.c. 60 Hz), Max. approx. 1.5 W (24 V d.c.) | | |
| Return time | Max. 100 ms | | |
| Time range | 01 | 0.01 ~ 1 s / 0.01 ~ 1 m / 0.01 ~ 1 h | |
| | 03 | 0.01 ~ 3 s / 0.01 ~ 3 m / 0.01 ~ 3 h | |
| | 06 | 0.01 ~ 6 s / 0.01 ~ 6 m / 0.01 ~ 6 h | |
| | 10 | 0.01 ~ 10 s / 0.01 ~ 10 m / 0.01 ~ 10 h | |
| | 30 | 0.01 ~ 30 s / 0.01 ~ 30 m / 0.01 ~ 30 h | |
| | 60 | 0.01 ~ 60 s / 0.01 ~ 60 m / 0.01 ~ 60 h | |
| Time error | Repeating error | Max. ±0.3 % (ratio of maximum scale) | |
| | Setting error | Max. ±5 % (ratio of maximum scale) | |
| Control output | Output mode | FLICKER (ON Start) | FLICKER (ON-A Start) |
| | Contact configuration | D type (time limit 1c) | F type (time limit 2c) |
| | Contact capacity | 250 V a.c. 3 A (Resistive load) | |
| Relay life | <ul style="list-style-type: none"> Mechanical life: min. 10 million times, Electrical life : min. 100,000 times | | |
| Dielectric strength | 2,000 V a.c. 60 Hz for 1 min | | |
| Noise immunity | ±2 kV (among operation power terminals), square wave noise by noise simulator (pulse width:1 μs) | | |
| Insulation resistance | Min. 100 MΩ (500 V d.c. Mega standard) | | |
| Vibration resistance | 10 - 55 Hz (for 1 min) single amplitude 0.5 mm X·Y·Z each direction 2 hours | | |
| Shock resistance | 300 m/s ² (30 G) X·Y·Z each direction 3 times | | |
| Storage temperature | -25 ~ 65 °C | | |
| Ambient temperature & humidity | -10 ~ 55 °C, 30 ~ 85 % RH (Without condensation) | | |
| Weight (g) | 150 | | |

Suffix code

| Model | Code | Content |
|------------------------------|---|--|
| Appearance | <input type="checkbox"/> - <input type="checkbox"/> <input type="checkbox"/> <input type="checkbox"/> <input type="checkbox"/> <input type="checkbox"/> | Analog Timer |
| | TF62N | Twin timer 58(W) X 84(H) mm |
| | TF62D | Dual timer 58(W) X 84(H) mm |
| Installation structure | P | Panel type |
| | E | Exposed type |
| Range (Dip switch selection) | 01 | 1 sec, 1 min, 1 hour |
| | 03 | 3 sec, 3 min, 3 hour |
| | 06 | 6 sec, 6 min, 6 hour |
| | 10 | 10 sec, 10 min, 10 hour |
| | 30 | 30 sec, 30 min, 30 hour |
| | 60 | 60 sec, 60 min, 60 hour |
| Control output | D | TF62N Twin timer fixed code |
| | F | TF62D Dual timer fixed code |
| Power voltage | | 24-240 V a.c. 50/60 Hz or 24-240 V d.c. (Common) |
| | 12 | 12 V d.c. (only for T48N, order-made) |

※ Installation type selection is only applied to the model T57N, TF62N and TF62D (Model T38N requires separate purchase of panel adapter)

MA4N series

Specifications

| Model | MA4N-A | MA4N-B | MA4N-C |
|--------------------------------|---|--|---|
| Appearance |  | | |
| W X H X D (mm) | 48.0×48.0×61.3 | | |
| Power voltage | 24-240 V a.c. 50/60Hz or 24-240 V d.c. | | |
| Voltage fluctuation rate | ±10 % of power voltage | | |
| Power consumption | 5.3 VA (240 V a.c.), 2.5 W (240 V d.c.) | | |
| Return time | Max. 0.1 sec | | |
| Min signal width | START input, INHIBIT input, RESET input: min. 20 ms | | - |
| Input | <ul style="list-style-type: none"> ● Non-voltage input, ● Impedance during short circuit : max. 2 kΩ, ● Residual voltage during short circuit: max. 0.7 V d.c. , ● Impedance during open: min. 100 kΩ | | - |
| Output | Time limit 2c | Time limit 1c, instantaneous 1c | Time limit 2c, time limit 1c + instantaneous 1c |
| | <ul style="list-style-type: none"> ● NO : 10 A 125 V a.c., 5 A 250 V a.c., 5 A 30 V d.c. ● NC : 3 A 125 V a.c., 2 A 250 V a.c., 1 A 30 V d.c. | | |
| Repeating error | Max. ±0.3 % | | |
| Setting error | Max. ±5 % . ±0.05 sec | | |
| Temperature error | Max. ±2 % | | |
| Insulation resistance | Min. 100 MΩ (500 V d.c. mega standard) | | |
| Dielectric strength | 2,000 V a.c. 50/60 Hz for 1 min | | |
| Impulse voltage | Max. ±2000 V | | |
| Vibration resistance | 10 - 55 Hz Double amplitude 0.75 mm | | |
| Shock resistance | 300 m/s ² (approx. 30 G) | | |
| Life | Mechanical | Min. 10 million times (switching frequency 180 times / min) | |
| | Electrical | More than 100 thousand times (250 V a.c. 3 A resistive load) | |
| Terminal structure | Plug 11-pin | | Plug 8-pin |
| Ambient temperature & humidity | -10 ~ 55 °C, 35 ~ 85 % RH (단, 결로현상이 없을 것) | | |
| Storage temperature | -20 ~ 65 °C | | |
| Weight (g) | Approx. 100 g (fixtures included) | | |

| |
|---------------------------|
| New product Count/Timer |
| Small LCD counter |
| Digital Counter/Timer |
| New product Timer |
| Small LCD Timer |
| Digital Twin Timer |
| Digital Timer |
| Weekly/yearly Time switch |
| Timing Relay |
| Analog ON-Delay Timer |
| Analog Twin/Dual Timer |
| Analog Multi Timer |
| Star-delta Timer |

Suffix code

| Model | Code | Content |
|---------------|--------------------------|--|
| MA4N- | <input type="checkbox"/> | Analog Multi Timer |
| Type | A | Time limit 2c ※ 11-pin type |
| | B | Time limit 1c + instantaneous 1c ※11-pin type |
| | C | Time limit 2c, time limit 1c + instantaneous 1c ※ by mode selection (8-pin type) |
| Power voltage | | 24-240 V a.c. 50/60 Hz or 24-240 V d.c. |

ANALOG TIMERS

MA4SD

Specifications

| Model | | MA4SD | MA4SDI |
|------------------------------------|-----------------------|--|---|
| Appearance | |  | |
| W X H X D (mm) | | 48.0×48.0×61.3 | |
| Power voltage | | 100-240 V a.c. 50/60Hz, 24-240 V d.c. | |
| Allowable voltage fluctuation rate | | ±10 % of power voltage | |
| Power consumption | | Approx. 3.8 VA (100-240 V a.c. 60 Hz), Approx. 1.9 W (24-240 V d.c.) | |
| Return time | | Max. 100 ms | |
| Operating time range | | 1 ~ 300 Sec | |
| λ Operating time error | | ● Repetition error : max. ±0.3 % ● Setting error : max. ±5 % ● Voltage error : max. ±0.5 % ● Temperature tolerance : max. ±2 % (ratio of maximum scale) | |
| Δ Conversion time error | | Max. ±25 % | |
| Control output | Operation mode | Power ON Start | |
| | Contact configuration | λ Contacts : 1a, Δ Contacts : 1a | λ Contacts : 1a, Δ contacts: 1a, instantaneous contacts: 1a |
| | Contact capacity | 250 V a.c. 5 A resistive load | |
| Relay life | | ● Mechanical: min. 5 million times ● Electrical: min. 100,000 times (250 V a.c. 5 A resistive load) | |
| Insulation resistance | | Min. 100 MΩ (500 V d.c. Mega standard, conductive terminal - exposed unfilled metal part) | |
| Dielectric strength | | 2000 V a.c. 50/60 Hz for 2 min (conductive terminal - exposed unfilled metal part) | |
| Noise immunity | | ±2 kV (among operation power terminals, pulse width ±1 μs, square wave noise by noise simulator) | |
| Vibration resistance | | 10 - 55 Hz (for 1 min), double amplitude 0.75 mm X·Y·Z each direction 1 hour | |
| Shock resistance | | 300 m/s ² (30G) X·Y·Z each direction 3 times | |
| Ambient temperature & humidity | | -10 ~ 55 °C, 35 ~ 85 % RH (Without condensation) | |
| Storage temperature | | -25 ~ 65 °C | |
| Weight (g) | | Approx. 95 g (fixtures included) | |

Suffix code

| Model | Code | Content |
|----------------|------|---|
| MA4 | □ | Analog Multi Timer (Star-Delta Timer), 48 (W) × 48 (H) mm |
| Control output | SD | λ (Star) output, Δ (Delta) output |
| | SDI | Instantaneous output, λ (Star) output, Δ (Delta) output |

LP3



Specifications

| Model | | LP3-5A5 | LP3-5A3 | LP3-5AN |
|--------------------------------|-------------|---|-------------------------------|------------|
| Appearance | |  | | |
| WXHxD(mm) | | 96.0×48.0×71.1 | | |
| Power voltage | | 100-240 V a.c. 50/60 Hz | | |
| Power consumption | | Max. 15 VA | Max. 13 VA | Max. 10 VA |
| Display method | | Negative LCD display | | |
| Character size | | PV value (14.5 mm), SV value (10 mm) | | |
| Input frequency | | Contactless (max. 50 KHz, ON/OFF pulse width 10 us min), contact (max. 30 Hz, ON/OFF pulse width min. 16.6 ms) | | |
| Input type | Voltage | [H] level (4.5 - 24 V d.c.), [L] level (0 - 1 V d.c.), input impedance (4.5 kΩ) | | |
| | Non-voltage | Impedance during short circuit (max. 300 Ω), residual voltage (1 V max), impedance during open (min. 100 kΩ) | | |
| Measuring range | | F1, F2, F10, F11, F12, F13 : 0.0005 ~ 50 KHz, F3, F4, F5, F6 : 0.001 s ~ 3200 s, F7, F8, F9 : 0 ~ 4x10 ⁹ | | |
| Measuring accuracy | | F1, F4, F10, F11, F12, F13 : FS ±0.05 % rdg ±1 digit, F2, F3, F5, F6 : FS ±0.01 % rdg ±1 digit | | |
| External power supply | | 12 V d.c. ±10 % 100 mA | | |
| Display cycle | | 0.05 sec / 0.5 sec / 1 sec / 2 sec / 4 sec / 8 sec | | |
| Display range | | -99999 ~ 99999 | | |
| Power outage compensation | | Approx. 10 years (applying non-volatile EEPROM) | | |
| Control output | | HH (SPST), H (SPST), GO (SPST), L (SPST), LL (SPST) * HH/H output COM common, * LL/L output COM common | H (SPDT), GO (SPST), L (SPDT) | - |
| | | NO contact (250 V a.c. 5 A resistive load), NC contact (250 V a.c. 2 A resistive load) | | |
| Relay Life | Electrical | Min. 100 thousand times | | |
| | Mechanical | Min. 10 million times (250 V a.c. 2A) | | |
| Vibration resistance | | 10 - 55 Hz double amplitude 0.75 mm X·Y·Z each direction 2 hours | | |
| Insulation Resistance | | Min. 100 MΩ (500 V d.c.), conductive terminal - unfilled metal | | |
| Dielectric strength | | 2000 V a.c. at 60Hz for 1 min (different live part terminals) | | |
| Noise immunity | | ±2000 V (pulse width 1 μs, apply square wave noise by noise simulator among power terminals) | | |
| Degree of protection | | IP66 (IEC 60529) (product front) | | |
| Ambient temperature & humidity | | -10 ~ 50 °C, 35 ~ 85 % RH (Without condensation) | | |
| Storage temperature | | -20 ~ 60 °C | | |
| Certified | | | | |
| Weight (g) ※ | | 210 | 208 | 154 |

New product Multi-pulse meter
Small LCD Pulse meter
Multi Pulse meter
New product Multi Panel meter
Digital Multi Panel meter
Digital Wattmeter
Digital Voltage/Ammeter
Digital Frequency meter
Digital Scale meter
Digital Small type DC indicator

※ The weight includes the terminal cover and the cover weight is 8g.

Suffix code

| Model | Code | Content |
|-----------------------|------|--------------------------------|
| LP | □ | LCD Multi Pulse Meter |
| Appearance | 3 | 96(W) × 48(H) mm |
| Display digits | 5 | 5-Digit display |
| Power voltage | A | 100-240 V a.c. 50/60 Hz |
| Output specifications | N | Indication only |
| | 3 | 3-stage setting (H/GO/L) |
| | 5 | 5-stage setting (HH/H/GO/L/LL) |

PANEL METERS

LP1



Specifications

| | | |
|--------------------------------|-------------------------|--|
| Model | | LP1 |
| Appearance | |  |
| WXHxD(mm) | | 48.0×24.0×54.0 |
| Power voltage | | Non-power (battery built-in, changeable) |
| Display method | | LCD display method, zero blanking |
| Battery life | | More than approx. 3 years (approx. 25 °C) |
| Character size | | 8.7 mm |
| Input type | Voltage input (INB) | ● AC voltage input: 3 - 30 V a.c. ● DC voltage input: When High 4.5 - 30 V d.c. When Low 0 - 2 V d.c. |
| | Voltage input (INC) | 30-240 V a.c. |
| | Non-voltage input (INA) | ● Residual voltage during short circuit: max. 0.5 V, ● Max. impedance during short circuit: max. 10 kΩ, ● Min impedance during open: min. 500 kΩ |
| HOLD input method | | Non-voltage input |
| Measuring range | rpm | 1 ~ 10000 rpm |
| | 0.1 rpm | 0.1 ~ 1000.0 rpm |
| | rps | 1 ~ 1000 rps |
| | Hz | 1 ~ 1000 Hz |
| | 0.1 Hz | 0.1 ~ 100.0 Hz |
| External setting switch | | SW1-1 : rps / rpm, SW1-2 : ×1 / ×0.1, SW2-1 : RESET, SW2-2 : (rps, rpm) / Hz |
| External connection | | Terminal block (5 pins) |
| Measuring accuracy | | ±0.1% rdg ±1 digit |
| Vibration resistance | | 10 - 55 Hz (1 minute cycle) double amplitude 0.75 mm X·Y·Z each direction 1 hour |
| Shock resistance | | 300 m/s ² X·Y·Z each direction 3 times |
| Insulation Resistance | | Min. 100 MΩ (500 V d.c. Mega standard, conductive terminal - exposed unfilled metal part) |
| Dielectric strength | | 2000 V a.c 50/60 Hz for 1 min (conductive terminal - exposed unfilled metal part) |
| Ambient temperature & humidity | | -10 ~ 55 °C, 35 ~ 85 % RH (Without condensation) |
| Storage temperature | | -20 ~ 65 °C |
| Weight (g) | | 46 |

(note 1) The battery life is calculated based on the above conditions, so please consider them while replacing it

RP series

Specifications

| Model | | RP3 | RP6 | RP1 |
|--------------------------------|---------------------------------------|---|--|---|
| Appearance | |  |  |  |
| W X H X D (mm) | | 96.0×48.0×100.0 | 72.0×36.0×100.0 | 48.0×24.0×100.0 |
| Input | Contactless input | Max. 10 KHz (duty ratio 50 %, each 50 μs min) (ON voltage: 4.5 V ~ 24 V, OFF voltage: 0 ~ 1.0 V) | | |
| | Contact input | 30 Hz max. (duty ratio 50 %, each min. 16.6 ms) (it should be able to open and close enough current of 12 V d.c. 2 mA) | | |
| | Max. display digits | 5 digits (0 ~ 99999), 4 digits (0 ~ 9999) | | |
| | Display cycle | 0.05 sec, 0.5 sec, 1 sec, 2 sec, 4 sec, 8 sec | | |
| Performance | Measuring range | <ul style="list-style-type: none"> ● Moving speed (F2): 0.003 Hz ~ 1000 Hz ● Cycle (F3), transit time (F4), time difference (F5), time width(F6): 0.001 s ~ 3,200 s ● Number of revolutions / frequency / speed (F1): 0.0003 Hz ~ 10 KHz ● Pulse width(F7), pulse interval (F8), integration counter (F9): 0 ~ 4 X 10⁹ count | | |
| | Measuring accuracy | ±0.02 % rdg ±1 dig (mode F1, F2, F3, F4, F5), ±0.1 % rdg ±1 dig (Mode F6) | | |
| | Life (mechanical) | 20 million times | | |
| | Life (electrical) | <ul style="list-style-type: none"> ● 100,000 times when opening and closing 250 V a.c. 3 A (30 V d.c. 3 A) ● 50,000 times when opening and closing 250 V a.c. 5 A (30 V d.c. 5 A). Opening / closing speed is 20 times per minute | | |
| | Noise immunity | ±2000 V square wave noise by noise simulator (pulse width 1μs) | | |
| | Insulation Resistance | 10 MΩ min (500 V d.c., between live part - unfilled part) | | |
| Functions | Dielectric strength | 2000 V a.c. 60 Hz for 1 min (between power terminal - case, power terminal - input terminal) | | |
| | Display method | 7 Segment LED | | |
| | Operating mode | Number of revolutions / frequency / speed (F1), moving speed (F2), cycle (F3), transit time (F4), time difference (F5), time width (F6), pulse width (F7), pulse interval (F8), integration counter (F9) | | |
| | Prescale | 0.0001 X 10 ⁻⁹ ~ 9.9999 X 10 ⁹ RP1 0.001 X 10 ⁻⁹ ~ 9.999 X 10 ⁹ | | |
| | Hysteresis | 0 ~ 9999 (Only output type applied, setting range varies with mode) | | |
| Output | Other features | <ul style="list-style-type: none"> ● Time unit selection function, ● Start compensation timer function, ● Display cycle setting function, ● Parameter lock function, ● Auto zero time setting function, ● Power outage compensation function (F9 only), ● 4 measured values, Minimum measurement average value, 4 max. measured values, Max. measured average value storage function (10 types), ● Comparative output function (HH, H, GO, L, LL), ● Current output range selection function (only current output type) | | |
| | Comparison alarm output | <ul style="list-style-type: none"> ● NPN open collector (HH, H, GO, L, LL) (12 - 24 V d.c. max. 100 mA) ● Relay (HH, H, GO, L, LL) (5 A 250 V a.c.) | | |
| Power voltage | Retransmission output (display value) | 4 - 20 mA d.c. (load resistance max. 600 Ω) | | |
| | AC | 100-240 V a.c. 50/60 Hz | | |
| Power consumption | DC | 24-60 V a.c. 50/60 Hz, 24-60 V d.c. | | |
| | Voltage fluctuation rate | ±10 % of power voltage | | |
| Sensor power | AC | Approx. 9.5 VA | Approx. 12 VA | Approx. 10 VA |
| | DC | Approx. 5 W | Approx. 5 W | - |
| Vibration resistance | | 10 - 55 Hz double amplitude 0.75 mm X·Y·Z each direction 2 hours | | |
| Shock resistance | | 300 m/s ² X·Y·Z each direction 3 times | | |
| Ambient temperature & humidity | | -10 ~ 50 °C, 35 ~ 85 % RH (Without condensation) | | |
| Storage temperature | | -20 ~ 60 °C | | |
| Weight (g) | | 230 | 160 | 115 |

Suffix code

| Model | Code | Content | |
|-----------------------|--|---|---|
| RP | <input type="checkbox"/> - <input type="checkbox"/> <input type="checkbox"/> <input type="checkbox"/> <input type="checkbox"/> | Multi Pulse Meter | |
| Appearance | 1 | 48 (W) × 24 (H) mm | |
| | 3 | 96 (W) × 48 (H) mm | |
| | 6 | 72 (W) × 36 (H) mm | |
| Display digits | 4 | 4 digits 1 stage (0 - 9999) ※ Only RP1 | |
| | 5 | 5 digits 1 stage (0 - 99999) | |
| Power specifications | A | 100-240 V a.c. 50/60 Hz | |
| | D | 24-60 V a.c. 50/60 Hz, 24-60 V d.c. ※ RP1 excluded | |
| Output specifications | RP1 | H | Display only |
| | | 1 | Relay 1 stage (H : high limit output) |
| | RP3 | N | Display only |
| | | 1 | Relay 3 stages (H, GO, L) |
| | | 2 | Relay 5 stages (HH, H, GO, L, LL) |
| | RP6 | 4 | NPN open collector 5 stages, 4 - 20 mA d.c. (retransmission output) |
| | | N | Display only |
| 3 | 1 | Relay 3 stages (H, GO, L) | |
| | 3 | NPN open collector 5 stages, 4 - 20 mA d.c. (retransmission output) | |

New product
Multi-pulse
meter

Small LCD
Pulse meter

Multi
Pulse meter

New product
Multi Panel
meter

Digital
Multi Panel
meter

Digital
Wattmeter

Digital
Voltage/
Ammeter

Digital
Frequency
meter

Digital
Scale meter

Digital
Small type
DC indicator

PANEL METERS

BP6

Specifications

| | | | |
|--------------------------------|-------------------------|---|---|
| Model | | BP6 | |
| Appearance | |  | |
| W X H X D (mm) | | 72.0×36.0×100.0 | |
| Input | Contactless input | 50 KHz max.(Duty ratio 50 %, each min. 10 μs) (ON voltage 4.5 V - 24 V, OFF voltage 0 - 1.0 V) | |
| | Contact input | 30 Hz max.(Duty ratio 50 %, each min. 16.6 ms) (12 V d.c., can open and close enough current of 2 mA) | |
| | Max. display digits | 5 Digits (0 ~ 99999) | |
| | Display cycle | 0.05 sec, 0.5 sec, 1 sec, 2 sec, 4 sec, 8 sec | |
| | Measuring range | | Number of revolutions / frequency / speed (F1), absolute ratio (F10), error ratio (F11), density (F12), error (F13): 0.0005 Hz - 50 KHz |
| | | | Moving speed (F2) : 0.003 Hz - 1000 Hz |
| | | Cycle (F3), transit time (F4), time difference (F5), time width(F6): 0.001 s - 3,200 s Pulse width(F7), pulse interval (F8), integration counter (F9): 0 - 4 X 10 ⁹ Count | |
| Performance | Measuring accuracy | ±0.05 % rdg ±1 dig (Mode F1, F4, F10, F11, F12, F13), ±0.01 % rdg ±1 dig (Mode F2, F3, F5, F6) | |
| | Life (Mechanical) | 20 million times | |
| | Life (Electrical) | 100,000 times when opening and closing 250 V a.c. 3 A (30 V d.c. 3 A), 50,000 times when opening and closing 250 V a.c. 5 A (30 V d.c. 5 A) Opening / closing speed is 20 times per minute | |
| | Noise immunity | ±2000 V Square wave noise by noise simulator (pulse width 1μs) | |
| | Insulation resistance | 10 MΩ min (500 V d.c., between live part - unfilled part) | |
| | Dielectric strength | 2000 V a.c. 60 Hz for 1 min (between power terminal - case, power terminal - input terminal) | |
| Functions | Display method | 7 segment LED | |
| | Character size (mm) | 7.6 X 13.8 (W X H mm) | |
| | Operation mode | Number of revolutions, frequency, speed (F1), moving speed (F2), cycle (F3), transit time (F4), time difference (F5), time width (F6), pulse width (F7), pulse interval (F8), integration counter (F9), absolute ratio (F10), error ratio(F11), density(F12), error (F13) | |
| | Prescale | 0.0001 X 10 ⁻⁹ ~ 9.9999 X 10 ⁹ | |
| | Hysteresis | 0 ~ 9999 (Only output type applied, setting range varies with mode) | |
| Output | Comparison alarm output | NPN open collector (HH, H, GO, L, LL), (12-24 V d.c. 100 mA max.) | |
| | | Relay 3 stages (H, GO, L) | |
| Power voltage | | ● AC voltage(AC) : 100-240 V a.c. 50/60 Hz ● DC voltage(DC) :24-60 V a.c. 50/60 Hz, 24-60 V d.c. | |
| Voltage fluctuation rate | | ±10 % of power voltage | |
| Power consumption | | ● AC voltage(AC) : Approx. 10 VA ● DC voltage(DC) : Approx. 6 W | |
| Sensor power | | 12 V d.c. ±10 %, max. 120 mA | |
| Vibration resistance | | 10 - 55 Hz double amplitude 0.75 mm X·Y·Z each direction 2 hours | |
| Shock resistance | | 300 m/s ² (30 G) X·Y·Z each direction 3 times | |
| Ambient temperature & humidity | | -10 ~ 50 ° C, 35 ~ 85 % RH (Without condensation) | |
| Storage temperature | | -20 ~ 60 ° C | |
| Weight(g) | | 135 | |

Suffix code

| Model | Code | Content |
|-----------------------|--|-------------------------------------|
| BP | <input type="checkbox"/> - <input type="checkbox"/> <input type="checkbox"/> <input type="checkbox"/> <input type="checkbox"/> | Multi Pulse Meter |
| Appearance | 6 | 72(W) X 36(H) mm |
| Display digits | 5 | 5 Digits (-19999 - 99999) |
| Power voltage | A | 100-240Va.c. 50/60 Hz |
| | D | 24-60 V a.c. 50/60 Hz, 24-60 V d.c. |
| Output specifications | N | Display only |
| | 1 | Relay 3 stages output |

LM series

NEW

Specifications

| Model | LM3 | LM6 |
|---|--|----------------|
| Appearance |  | |
| WXHxD(mm) | 96.0×48.0×68.0 | 72.0×36.0×81.0 |
| Power voltage | 100-240 V a.c. 50/60 Hz | |
| Input Signal | <ul style="list-style-type: none"> ● DV : DC Voltage ● DA : DC current ● AV : AC Voltage / Frequency ● AA : AC Current / Frequency | |
| Maximum measurement input specification | <ul style="list-style-type: none"> ● DV : 500V ● DA : 5A ● AV : 500V ● AA : 5A | |
| Alternating current measurement method | AVG / RMS Selective measurement | |
| Frequency instrumentation range | 0.1 ~ 9999 Hz | |
| Display | Negative-LCD, Row 4, Column 2, PV:White, SV:Green | |
| Character Size | 18.1 X 11.0 mm | 11.5 X 7.5 mm |
| Maximum display | -9999 ~ 9999 | |
| Sampling period | <ul style="list-style-type: none"> ● DV/DA : 50ms ● AV/AA : 16.6ms | |
| Display degree (23°C) | <ul style="list-style-type: none"> ● DC : FS ±0.1% rdg ±2digit ● AC : FS ±0.3% rdg ±3digit ● Frequency : FS ±0.1% rdg ±2digit | |
| Control Output | <ul style="list-style-type: none"> ● Contact Output: 3-layer, SPST (1a), 250Va.c. 5A ● Contactless output: 3-speed, NPN/PNP, Open Collector, 12-24 V d.c. 50 mA | |
| Optional Output | Transmission Output (4 - 20 mA), RS485 Output | |
| External input | <ul style="list-style-type: none"> ● HOLD / ZERO Select input, voltage-free input, ● impedance at short circuit: 300 Ω or less, ● residual voltage: 1 V or less, ● impedance at open time: 100 kΩ or more. | |
| Communication | <ul style="list-style-type: none"> ● Protocol : Modbus-RTU ● Communication method: RS485 (two-line half duplex) ● Communication speed : 2400 / 4800 / 9600 / 19200 / 38400 bps | |
| Protective Structure | IP66 (front), terminal protection COVER applied | |
| Function | <ul style="list-style-type: none"> ● Operation mode (6), ● hysteresis, ● alternating current frequency measurement, ● Zeroing, ● Initialization, ● Lower Display Value Deviation Calibration, ● Scale transmission output, ● Maneuver compensation timer, ● Freescale , ● Tilt adjustment, ● Error correction, ● Display cycle delay, ● Monitor Maximum/Minimum, ● Lock Key | |

New product
Multi-pulse
meter

Small LCD
Pulse meter

Multi
Pulse meter

New product
Multi Panel
meter

Digital
Multi Panel
meter

Digital
Wattmeter

Digital
Voltage/
Ammeter

Digital
Frequency
meter

Digital
Scale meter

Digital
Small type
DC indicator

Suffix code

| Model | Code | Content |
|-----------------------|---|-----------------------------------|
| LM | <input type="checkbox"/> <input type="checkbox"/> <input type="checkbox"/> <input type="checkbox"/> <input type="checkbox"/> <input type="checkbox"/> | LCD Multi Pulse Meter |
| Appearance | 3 | 96(W) X 48(H) |
| | 6 | 72(W) X 36(H) |
| Display digits | 4 | 4-Digit display |
| Power voltage | DV | DC Voltage |
| | DA | DC Current |
| | AV | AC Voltage |
| | AA | AC Current |
| Output specifications | N | Directions only |
| | 3R | 3-Speed contact output |
| | 3N | 3-Speed NPN Open Collector Output |
| | 3P | 3-Speed PNP Open Collector Output |
| Optional Output | - | Unmarked (no optional output) |
| | C | RS485 Output (MODBUS-RTU) |
| | A | Current Output (4-20 mA d.c.) |
| Power Voltage | A | 100-240 V a.c. 50/60 Hz |

PANEL METERS

MP3 series

Specifications

| Model | | MP3 |
|----------------------------------|---------------------------------|---|
| Appearance | |  <p><Front Plate Type> <Front Acrylic Type></p> |
| W×H×D (mm) | | 96.0×48.0×102.6 |
| Input | Input signal | AC (voltage, current), DC (voltage, current) |
| | A/D converter | 2-Way integral method |
| | Sampling cycle | DC type : 100 ms, AC type : 300 ms |
| | Response speed | Approx. 0.3 sec (max. range) |
| | Max. display digits | 4 Digits (-1999 ~ 9999) |
| | Display | 7 segment LED |
| Performance | Accuracy | AC : ±0.5 % of FS ±1 Digit, DC : ±0.2 % of FS ±1 Digit |
| | Insulation Resistance | Min. 100 MΩ (500 V d.c. mega standard) between external terminal and case |
| | Dielectric strength | Min. 2000 V a.c. for 1 min (between external terminal and case) |
| Function | | <ul style="list-style-type: none"> ● Multi Inputrange, ● Magnification, ● Input correction, ● Refresh interval, ● Start compensation time, ● Scaling function, ● RMS measurement, ● Decimal position, ● Hold function, ● Lock function, ● Communication address, ● Communication speed, ● Output operation (PSOT)selection, ● Hysteresis settings, ● Automatic zero indication |
| Output | Communication output (RS485) | Addresses can be set from 00 to 99 and the modulation speed of the serial retransmission can be selected. (retransmission speed: 1200, 2400, 4800, 9600, 19200 bps) |
| | Serial communication | Generate the sign (POL), decimal point (DOT), clock, data, latch signal in order to make the current present value to the programmable controller and process |
| | Current output (retransmission) | 4 - 20 mA d.c. output for current present value (Resolution: 12000) |
| | BCD output | Output current present value in BCD format (D0, D1, D2, D3, POL, DOT, A0, A1, A2, A3) |
| | Transistor output | PNP/NPN open collector output (12-24 V d.c. max. 50 mA) |
| | Relay output | 1 c X 3 contacts(HI, GO, LO), (220 V a.c. 5 A) |
| Power voltage | AC | 100-240Va.c. 50/60 Hz (Allowable voltage fluctuation range: ±10 %) |
| | DC | 24 V d.c. (Allowable voltage fluctuation range: ±10 %) |
| Power consumption | AC | 5 VA |
| | DC | 5 W |
| Vibration resistance | Malfunction | 50 / 60 Hz, Pile width 0.5 mm, X·Y·Z each direction 1 hours |
| | Durability | 50 / 60 Hz, Pile width 0.5 mm, X·Y·Z each direction 2 hours |
| Shock resistance | Malfunction | 100 m/s, X·Y· Z 3 times each direction |
| | Durability | 300 m/s, X·Y· Z 3 times each direction |
| Noise | | Square Wave Noise Pulse Width 1μs, ±1000 V by Noise Simulator |
| Ambient temperature for use | | -10 ~ 55°C (Do not freeze.) |
| Usage Ambient Humidity | | Relative Humidity 35 to 85% RH |
| Peripheral environment | | No corrosive gases |
| Preservation ambient temperature | | -20 ~ 65°C (Do not freeze) |
| Relay Life | | Mechanical : 20,000,000 ps Min, Electrical : 100,000 ps Min |
| Weight (g) | | 218.4 |

Suffix code

| Model | Code | Content |
|---------------------------------|---|---|
| MP3- | <input type="checkbox"/> <input type="checkbox"/> <input type="checkbox"/> <input type="checkbox"/> | Digital Multi Panel Meter 96(W) X 48(H) mm |
| Display digits | 4 | 4 Digits (9999) |
| Measurement input specification | DV | DC VOLT |
| | DA | DC AMPERE |
| | AV | AC VOLT |
| | AA | AC AMPERE |
| | AVR | AC VOLT (RMS) |
| | AAR | AC AMPERE (RMS) |
| Output (optional) | N | Display only |
| | 0 | Relay output (HI, GO, LO), Current output (4 - 20 mA) |
| | 1 | Relay output (HI, GO, LO) |
| | 2 | NPN open collector (HI, GO, LO), BCD output (Dynamic) |
| | 4 | NPN open collector (HI, GO, LO), Current output (4 - 20 mA) |
| | 5 | PNP open collector (HI, GO, LO), Current output (4 - 20 mA) |
| | 8 | NPN open collector (HI, GO, LO), RS485 output |
| | 9 | PNP open collector (HI, GO, LO), RS485 output |
| | 10 | BCD output (Static) |
| | 11 | Relay output (HI, GO, LO), RS485 output |
| Distinguished (Type) | A | Front Case: Acrylic Type (100-240 V a.c.) |
| | B | Front case: Nameplate type (100-240 V a.c.) |
| | C | Front case: Nameplate type (24 V d.c.) |

※ Output specifications 1 to 11 are optional.

※ DCV should be selected when selecting a product because a dedicated shunt should be used to measure current above 5 A d.c.

※ Only AVR, AAR output specifications 0, 1 are produced for 24 Vd.c.

New product
Multi-pulse
meter

Small LCD
Pulse meter

Multi
Pulse meter

New product
Multi Panel
meter

Digital
Multi Panel
meter

Digital
Wattmeter

Digital
Voltage/
Ammeter

Digital
Frequency
meter



Digital
Scale meter

Digital
Small type
DC indicator

PANEL METERS

MP6 series

Specifications

| Model | | MP6 |
|-----------------------------|---------------------------------|---|
| Appearance | |   <Front plate type> <Front acrylic type> |
| W×H×D (mm) | | 72.0×36.0×100.0 |
| Input | Input signal | AC (voltage, current), DC (voltage, current) |
| | A/D converter | 2-way integral method |
| | Sampling cycle | DC type: 100 ms, AC type: 300 ms |
| | Response speed | Approx. 0.3 sec (max. range) |
| | Max. display digits | 4 Digits (-1999~9999) |
| | Display | 7 segment LED |
| Performance | Accuracy | AC : ±0.5 % of FS ±1 Digit, DC : ±0.2 % of FS ±1 Digit |
| | Insulation Resistance | Min. 100 MΩ (500 V d.c. Mega standard) between external terminal and case |
| | Dielectric strength | Min. 2000 V a.c. for 1 min (between external terminal and case) |
| Functions | | <ul style="list-style-type: none"> ● Multi Input range, ● Refresh interval, ● Start compensation time, ● Input correction, ● Scaling, ● RMS measurement, ● Decimal position, ● Hold function, ● Lock, ● Communication address, ● Communication speed, ● Output operation (PSOT)selection, ● Hysteresis settings, ● Automatic zero indication |
| Output | Communication output(RS485) | Addresses can be set from 00 to 99 and the modulation speed of the serial retransmission can be selected. (Retransmission speed: 1200, 2400, 4800, 9600, 19200 bps) |
| | Serial communication | Generate the sign (POL), decimal point (DOT), clock, data, latch signal in order to make the current present value to the programmable controller and process |
| | Current output (retransmission) | 4 - 20 mA d.c. output for current present value (Resolution: 12000) |
| | BCD output | Output current present value in BCD format (D0, D1, D2, D3, POL, DOT, A0, A1, A2, A3) |
| | Transistor output | PNP/NPN open collector output (12 - 24 V d.c. max. 50 mA) |
| | Relay output | 1 c X 3 contacts (HI, GO, LO), (220 V a.c. 5 A) |
| Power voltage | AC | 100-240 V a.c. 50/60 Hz (Allowable voltage fluctuation range: ±10 %) |
| | DC | 24 V d.c. (Allowable voltage fluctuation range: ±10 %) |
| Power consumption | AC | 5 V A |
| | DC | 5 W |
| Vibration resistance | Malfunction | 50 / 60 Hz, 0.5 mm, X, Y, and Z, 1 hour in each direction |
| | Durability | 50 / 60 Hz, 0.5 mm, X, Y, and Z, 2 hour in each direction |
| Shock resistance | Malfunction | 100 m/s, X·Y·Z each direction 3 times |
| | Durability | 300 m/s, X·Y·Z each direction 3 times |
| Noise resistance | | Square Wave Noise Pulse Width by Noise Simulator 1μs, ±1000 V |
| Ambient temperature for use | | -10 ~ 55°C (Do not freeze) |
| Usage Ambient Humidity | | Relative Humidity 35 ~ 85% RH |
| Peripheral environment | | No corrosive gases |
| Storage temperature | | -20 ~ 65°C (Do not freeze) |
| Relay life | | Mechanical : 20,000,000 ps Min, Electrical : 100,000 ps Min |
| Weight (g) | | 148.7 |

Suffix code

| Model | Code | Content |
|---------------------------------|---|---|
| MP6- | <input type="checkbox"/> <input type="checkbox"/> <input type="checkbox"/> <input type="checkbox"/> | Digital Multi Panel Meter |
| Display digits | 4 | 4 Digits (9999) |
| Measurement input specification | DV | DC VOLTAGE |
| | DA | DC AMPERE |
| | AV | AC VOLTAGE |
| | AA | AC AMPERE |
| | AVR | AC VOLTAGE (RMS) |
| | AAR | AC AMPERE (RMS) |
| Output Specification | N | Display only |
| | 0 | Relay output (HI, GO, LO), Current output (4 - 20 mA) |
| | 1 | Relay output (HI, GO, LO) |
| | 4 | NPN open collector (HI, GO, LO), Current output (4 - 20 mA) |
| Type | A | Front : Acrylic Type (100-240Va.c.) |
| | B | Front : Plate Type (100-240 V a.c.) |
| | C | Front : Plate Type (24 V d.c.) |

※ Output specifications 1 to 4 are optional.
 ※ DCV should be selected when selecting a product because a dedicated shunt should be used when measuring current above 5 Ad.c.
 ※ 24 V d.c. produces only AVR, AAR output specifications 0, 1.

WM3

Specifications

| Model | WM3 |
|--------------------------------|--|
| Appearance |  |
| WXHxD(mm) | 96.0×48.0×102.0 |
| Method of measurement | Periodic measurement method |
| Input Voltage | 0 - 220 V a.c. |
| Display Cycle | 0.1 ~ 2 sec |
| Power factor | 80 ~ 100 % |
| Response speed | 2 seconds (maximum range) |
| Number of displayed lines | 4 Digit (-1999 ~ 9999) |
| Display | 7 Segment LED |
| Accuracy | ±0.5 % of FS, ±10 Digit |
| Insulation Resistance | 100 MΩ or more (500 V d.c.) |
| Voltage Resistance | 2,000 V a.c. 1 minute (power terminal - input terminal) |
| Function | <ul style="list-style-type: none"> ● Measurement item, ● Show Average Value, ● Scale Functions, ● Set Decimal Point, ● Hold, ● Show Maximum/Minimum, ● Communication Functions, ● Effective Value (RMS) measurement function, ● Decimal Point Location, ● Hold function, ● Lock function, ● Address, ● Communication speed, ● Show Maximum Value, ● Show Min Value, ● Upper limit setting, ● Lower limit setting, ● Select Output Behavior (PSOT), ● Hysteresis Settings, |
| Communication Output (RS485) | You can set the address from 00 to 99 times and select the modulation rate for serial transmissions (transmission rate: 1200, 2400, 4800, 9600, 19200 bps) |
| Current Output (Transfer) | 4-20 mA d.c. output for the current indicator (resolution: 12,000) |
| Transistor Output | PNP/NPN Open Collector Output (12-24V d.c. 50mA or less) |
| Relay Output | 1 a X 3 Contact (HI, GO, LO), (220 V a.c. 5 A) |
| Power Voltage | 100-240 V a.c. 50/60 Hz (Common) |
| Voltage Fluctuation Rate | -15 to 10% of the power voltage |
| Power Consumed | Approx. 5 VA |
| Ambient temperature & humidity | 0 ~ 50 °C, 35 ~ 85 % RH (No condensation) |
| Storage temperature | -10 ~ 70 °C |
| Vibration resistance | 10-55 Hz single amplitude for 2 hours in each of X, Y, and Z directions |
| Shock resistance | 300 m/s ² X·Y·Z 6 each direction 3 times |
| Weight (g) | 300 |

| |
|---------------------------------|
| New product Multi-pulse meter |
| Small LCD Pulse meter |
| Multi Pulse meter |
| New product Multi Panel meter |
| Digital Multi Panel meter |
| Digital Wattmeter |
| Digital Voltage/ Ammeter |
| Digital Frequency meter |
| Digital Scale meter |
| Digital Small type DC indicator |

Suffix code

| Model | Code | Content |
|----------------------|--|---|
| WM3- | <input type="checkbox"/> <input type="checkbox"/> <input type="checkbox"/> | Digital power meter |
| Constants and Wires | 1 | Single-phase 2-ray (0-220 V a.c.) |
| Input Specifications | 01 | Input Specification Reference (see code) |
| Output (optional) | N | Display Only |
| | 0 | Relay (HI, GO, LO), 4-20mA d.c. |
| | 1 | Relay (HI, GO, LO) |
| | 2 | NPN open Collector (HI, GO, LO), 4-20 mA d.c. |
| | 3 | PNP open Collector (HI, GO, LO), 4-20 mA d.c. |
| | 4 | NPN open Collector (HI, GO, LO), RS485 |
| | 5 | PNP open Collector (HI, GO, LO), RS485 |



Input Specifications

| Code | Content | | |
|------|-----------|-----------------------------|---|
| 01 | XXX : 5 A | Universal Translator | Set Transmission Ratio (CT sold separately) |
| 02 | XXX : 1 A | | Set Transmission Ratio (CT sold separately) |
| 03 | 0 - 2.5 A | Dedicated Translator (H-1W) | 0 - 500.0 W max. (With CT) |
| 04 | 0 - 5 A | | 0 - 1100.0 W max. (With CT) |
| 05 | 0 - 10 A | | 0 - 2200.0 W max. (With CT) |
| 06 | 0 - 15 A | | 0 - 3300.0 W max. (With CT) |
| 07 | 0 - 30 A | | 0 - 6600.0 W max. (With CT) |
| 08 | 0 - 50 A | Dedicated Translator (H-2W) | 0 - 11.00 KW max. (With CT) |
| 09 | 0 - 80 A | | 0 - 17.60 KW max. (With CT) |
| 10 | 0 - 100 A | Dedicated Translator (H-4W) | 0 - 22.00 KW max. (With CT) |
| 11 | 0 - 150 A | | 0 - 33.00 KW max. (With CT) |
| 12 | 0 - 200 A | Dedicated Translator (H-5W) | 0 - 44.00 KW max. (With CT) |

PANEL METERS

BS series

Specifications

| Model | BS3 | BS6 | BS1 | |
|--------------------------------|---|---|---|----------------------------|
| Appearance |  |  |  | |
| WXHxD(mm) | 96.0×48×102.0 | 72.0×36.0×100.0 | 48.0×24.0×100.0 | |
| Input | Input signal | Input voltage, current, instrument signal input (4 - 20 mA d.c. or 1 - 5 V d.c.) | | |
| | A/D converter | Double integration method | | |
| | Sampling cycle | 300 ms | 400 ms | |
| | Response speed | Approx. 2 sec (max. range) | | Approx. 3 sec (max. range) |
| | External control | Present value hold function by contact input | | |
| | Max. display digits | ± 1999 | | |
| | Display | 7 segment LED | | |
| Performance | Measurement and indication method | Effective value indicating method by full-wave rectification | | |
| | Accuracy | AC : ±0.5 % of FS ±1 Digit, DC : ±0.2 % of FS ±1 Digit | | |
| | Insulation resistance | Min. 100 MΩ (500 V d.c.) | | |
| Dielectric strength | 1500 V a.c. for 1 min (between external terminal and case) | 2000 V a.c. for 1 min (between external terminal and case) | | |
| Power voltage | 110 V / 220 V a.c. 50/60 Hz common | | 100-240 V a.c. 50/60 Hz common | |
| Voltage fluctuation rate | ±10 % of power voltage | | -15 ~ 10 % of power voltage | |
| Power consumption | Max. 2 VA | | Max. 4 VA | |
| Ambient temperature & humidity | 0 ~ 50 °C, 35 ~ 85 % RH (without condensation) | | -10 ~ 55 °C, 35 ~ 85 % RH (without condensation) | |
| Storage temperature | -10 ~ 70 °C | | -20 ~ 65 °C | |
| Vibration resistance | 10 - 55 Hz single amplitude X·Y·Z each direction 2 hours | | | |
| Shock resistance | 300 m/s, X·Y·Z 6 directions each 3 times | | | |
| Weight (g) | 350 | 250 | 150 | |

Suffix code

※ Model name : BS6 and BS3 have different range codes

| Model | Code | Content |
|-----------------|--|--|
| BS | <input type="checkbox"/> - <input type="checkbox"/> <input type="checkbox"/> <input type="checkbox"/> <input type="checkbox"/> | Digital Voltmeter / Ammeter |
| Appearance | 6 | 72 X 36 mm |
| | 3 | 96 X 48 mm |
| | 1 | 48 X 24 mm |
| Output | N | Display only |
| Input | A 10 | AC voltmeter (AC) |
| | A 20 | AC ammeter (AC) |
| | D 10 | DC voltmeter (DC) |
| | D 20 | DC ammeter (DC) |
| | D 21 | DC voltmeter |
| Measuring range | 1 | Measuring range model example: BS3-NA101 (1.999 V) |

● DC current (BS1)

| Model | Measuring range | Resolution | Input impedance | Max. allowable input current |
|-----------|-----------------|------------|---------------------------------------|------------------------------|
| BS1-ND201 | 199.9 μA | 0.1 μA | 1 kΩ | 50 mA |
| BS1-ND202 | 1.999 mA | 1 μA | 100 Ω | 150 mA |
| BS1-ND203 | 19.99 mA | 10 μA | 10 Ω | 300 mA |
| BS1-ND204 | 199.9 mA | 100 μA | 1 Ω | 3 A |
| BS1-ND205 | 1.999 A | 1 mA | 0.1 Ω | 3 A |
| BS1-ND206 | 5.00 A | 10 mA | 0.01 Ω | 5 A |
| BS1-ND207 | 19.99 A | 10 mA | Shunt use (secondary voltage 50mV) | |
| BS1-ND208 | 199.9 A | 100 mA | | |
| BS1-ND209 | 1999 A | 1 A | | |

● DC current (BS3)

| Model | Measuring range | Resolution | Input impedance | Max. allowable input current |
|-----------|-----------------|------------|---------------------------------------|------------------------------|
| BS3-ND201 | 1.999 mA | 1 μA | 100 Ω | 50 mA |
| BS3-ND202 | 19.99 mA | 10 μA | 10 Ω | 150 mA |
| BS3-ND203 | 199.9 mA | 100 μA | 1 Ω | 300 mA |
| BS3-ND204 | 1.999 A | 1 mA | 0.1 Ω | 3 A |
| BS3-ND205 | 5.00 A | 10 mA | 0.01 Ω | 5 A |
| BS3-ND206 | 19.99 A | 10 mA | Shunt use (secondary voltage 50mV) | |
| BS3-ND207 | 199.9 A | 100 mA | | |
| BS3-ND208 | 1999 A | 1 A | | |

● DC current (BS6)

| Model | Measuring range | Resolution | Input impedance | Max. allowable input current |
|-----------|-----------------|------------|---------------------------------------|------------------------------|
| BS6-ND201 | 199.9 μA | 0.1 μA | 100 Ω | 1 mA |
| BS6-ND202 | 1.999 mA | 1 μA | 10 Ω | 50 mA |
| BS6-ND203 | 19.99 mA | 10 μA | 1 Ω | 150 mA |
| BS6-ND204 | 199.9 mA | 100 μA | 0.1 Ω | 300 mA |
| BS6-ND205 | 5.00 A | 10 mA | 400 MΩ | 5.1 A |
| BS6-ND206 | 19.99 A | 10 mA | Shunt use (secondary voltage 50mV) | |
| BS6-ND207 | 199.9 A | 100 mA | | |
| BS6-ND208 | 1999 A | 1 A | | |

Measuring range ● AC current (BS3, BS6, BS1)

| Model | Measuring range | Resolution | Input impedance | Max. allowable input current |
|-----------|-----------------|------------|---|------------------------------|
| BS□-NA201 | 19.99 mA | 10 μA | 10 Ω | 50 mA |
| BS□-NA202 | 199.9 mA | 100 μA | 1 Ω | 300 mA |
| BS□-NA203 | 1.999 A | 1 mA | 0.1 Ω | 3 A |
| BS□-NA204 | 5.00 A | 10 mA | 40 MΩ | 5.1 A |
| BS□-NA205 | 19.99 A | 10 mA | Current transformer use (secondary current 5A) | |
| BS□-NA206 | 30.0 A | 100 mA | | |
| BS□-NA207 | 100.0 A | 100 mA | | |
| BS□-NA208 | 150.0 A | 100 mA | | |
| BS□-NA209 | 199.9 A | 100 mA | | |
| BS□-NA210 | 300 A | 1 A | | |
| BS□-NA211 | 1999 A | 1 A | | |

● AC voltage (BS3)

| Model | Measuring range | Resolution | Input impedance | Max. allowable input current |
|-----------|-----------------|------------|-----------------|------------------------------|
| BS3-NA101 | 1.999 V | 1 mV | 100 kΩ | 10 V |
| BS3-NA102 | 19.99 V | 10 mV | 1 MΩ | 50 V |
| BS3-NA103 | 199.9 V | 100 mV | 10 MΩ | 300 V |
| BS3-NA104 | 400 V | 1 V | 10 MΩ | 500 V |
| BS6-NA105 | 400 V | 1 V | 10 MΩ | 500 V |

● AC voltage (BS6, BS1)

※ Model name: BS1-NA105 (range: 500V)

| Model | Measuring range | Resolution | Input impedance | Max. allowable input current |
|------------|-----------------|------------|-----------------|------------------------------|
| BS □-NA101 | 199.9 mV | 0.1 mV | 10 kΩ | 10 V |
| BS □-NA102 | 1.999 V | 1 mV | 100 kΩ | 10 V |
| BS □-NA103 | 19.99 V | 10 mV | 1 MΩ | 50 V |
| BS □-NA104 | 199.9 V | 100 mV | 10 MΩ | 300 V |
| BS6-NA105 | 400 V | 1 V | 10 MΩ | 500 V |
| BS1-NA105 | 500 V | | | |

● DC ammeter (BS3, BS6, BS1)

| Model | Input | Display range | Input impedance | Max. allowable input current |
|------------|------------|---------------|-----------------|------------------------------|
| BS □-ND211 | 4-20 mA DC | 50.0 | 25 Ω | 150 mA |
| BS □-ND212 | | 100.0 | 50 Ω | 150 mA |
| BS □-ND213 | | 199.9 | 100 Ω | 150 mA |

● DC voltmeter (BS3, BS6, BS1)

| Model | Input | Display range | Input impedance | Max. allowable input current |
|------------|----------|---------------|-----------------|------------------------------|
| BS □-ND111 | 1-5Vd.c. | 50.0 | 500 kΩ | 100 V |
| BS □-ND112 | | 100.0 | 500 kΩ | 100 V |
| BS □-ND113 | | 199.9 | 500 kΩ | 100 V |



Input Measuring range 0 - 10 V d.c. (optional)

● DC voltage (BS3, BS6, BS1)

| Model | Measuring range | Resolution | Input impedance | Max. allowable input voltage |
|-----------|-----------------|------------|-----------------|------------------------------|
| BS□-ND101 | 199.9 mV | 0.1 mV | 10 kΩ | 70 V |
| BS□-ND102 | 1.999 V | 1 mV | 100 kΩ | 100 V |
| BS□-ND103 | 19.99 V | 10 mV | 1 MΩ | 200 V |
| BS□-ND104 | 199.9 V | 100 mV | 10 MΩ | 300 V |
| BS□-ND105 | 500 V | 1 V | 10 MΩ | 600 V |

MP3-4H, MP6-4H

Specifications

| Model | | MP3-4H | MP6-4H |
|-------------------------------------|---------------------------------|--|---|
| Appearance | |  |  |
| WXHxD(mm) | | 96.0×48.0×102.6 | 72.0×36.0×100.5 |
| Input | Input signal | AC voltage | |
| | Measuring method | Count measuring method | |
| | Response speed | Approx. 2 sec (max. range) | |
| | Max. display digits | 4 Digits (-1999~9999) | |
| | Display | 7 Segment LED | |
| Performance | Accuracy | Max. ±5 digit | |
| | Insulation Resistance | Min. 100 MΩ (500 V d.c.) | |
| | Dielectric strength | 2000 V a.c. for 1 min (between input terminal and case) | |
| Output | Current output (retransmission) | - | 4 - 20 mA d.c. output for current present value (Resolution: 12000) |
| | Transistor output | - | PNP / NPN open collector output (12 - 24 V d.c. max. 50 mA) |
| | Relay output | - | 1a X 3 contacts (HI, GO, LO), (220 V a.c. 5 A) |
| Input range | | AC voltage (5 V a.c., 50 V a.c., 500 V a.c.), 0.1 ~ 9999 Hz | |
| Functions | | <ul style="list-style-type: none"> ● Input correction, ● Refresh interval, ● Decimal position, ● Hold, ● Lock, ● Max. value display, ● Min value display, ● High limit setting, ● Low limit setting, ● Output operation (PSOT)selection, ● Hysteresis settings | |
| Power voltage | | 100-240 V a.c. 50/60 Hz (Common) | |
| Allowable voltage fluctuation range | | 85 - 264 V a.c. | |
| Power consumption | | Approx. 5 VA | Approx. 5 VA |
| Ambient temperature & humidity | | -10 ~ 65 °C, 35 ~ 85 % RH (without condensation) | |
| Storage temperature | | -20 ~ 65°C | |
| Vibration resistance | | 10 - 55 Hz single amplitude X·Y·Z each direction 2 hours | |
| Shock resistance | | 300 m/s, X·Y·Z each direction 3 times | |
| Weight (g) | | 180 | |

New product
Multi-pulse
meter

Small LCD
Pulse meter

Multi
Pulse meter

New product
Multi Panel
meter

Digital
Multi Panel
meter

Digital
Wattmeter

Digital
Voltage/
Ammeter

Digital
Frequency
meter

Digital
Scale meter

Digital
Small type
DC indicator

Suffix code

| Model | Code | Content |
|-------------------|---|---|
| MP | <input type="checkbox"/> <input type="checkbox"/> <input type="checkbox"/> <input type="checkbox"/> | Digital Frequency Meter |
| Appearance | 3 | 96(W) × 48(H) mm |
| | 6 | 72(W) × 36(H) mm |
| Display digits | 4 | 4 Digits (9999) |
| Output (optional) | N | Display only |
| | 0 | Relay output (HI, GO, LO) + Current output(4-20 mA) |
| | 1 | Relay output (HI, GO, LO) |
| | 2 | NPN TR 출력(HI, GO, LO) + Current output(4-20 mA) |
| | 3 | PNP TR 출력(HI, GO, LO) + Current output(4-20 mA) |
| Output (optional) | H | AC input frequency measurement |

※ The optional specifications are MP6-4 H, and the MP3-4 H optional specifications will be developed in the future

PANEL METERS

HP3

Specifications

| Model | | HP3 |
|-----------------------|--------------------------------|---|
| Appearance | |  |
| WXHxD(mm) | | 96.0×48.0×100.0 |
| Input | Input contact | 1 Channel |
| | Input signal | 4 - 20 mA / 1-5 V d.c. (2-wire current output and 3-wire voltage output type transducer only) |
| | Max. display digits | 5 Digits (±19999) |
| | Sampling cycle | 500 ms |
| | Input correction | -100 ~ 100 % of FS |
| | Input filter setting | 0 ~ 100 sec |
| Performance | Degree of Display | ±0.03 % of FS |
| | Retransmission output | 4-20 mA d.c. (Load resistance: max. 600 Ω) |
| | Insulation resistance | 100 MΩ (500 V d.c.) |
| | Dielectric strength | 2,300 V a.c. 50/60 Hz for 1 min |
| Functions | Alarm setting | 2 Contacts (AL1, AL2) |
| | Alarm Hysteresis setting | AL1, AL2 each setting (0 ~ 10 % of FS) |
| | Communication function | Select between RS232 or RS485 |
| | Retransmission type | Select retransmission output by parameter (DIR, REV, SQRT) |
| | Scale setting | -19999 ~ 19999 |
| | Decimal places setting | 0 ~ 4 |
| | Filter setting | 0 ~ 100 sec |
| | Present value correction | -100 ~ 100 % of FS |
| | Sensor disconnection selection | Selection by parameter UP(0)/DOWN (1)/OFF(2) |
| | LOCK Functions | Data setting lock function selection OFF (0) / ON (1) |
| Output | Alarm output | Output points: 1c X 2 contacts (AL1, AL2) |
| | | Contact capacity: 5 A 240 V a.c. (5 A 30 V d.c.) |
| | | Resolution : 125 ms |
| | Retransmission output | Hysteresis : 0~10 % of FS |
| | | Retransmission type : Selection by parameter (DIR, REV, SQRT) |
| | | Output points : 1 contact |
| Normal specifications | Power voltage | 100-240 V a.c. 50/60 Hz |
| | Voltage fluctuation rate | ±10 % of power voltage |
| | Power consumption | Approx. 5 VA |
| | Ambient temperature & humidity | -5 ~ 50 °C, 20 ~ 90 % RH (Without condensation) |
| | Storage temperature | -25 ~ 70 °C |
| | Vibration resistance | 10 - 55 Hz single amplitude X·Y·Z each direction 2 hours |
| | Shock resistance | 300 m/s ² , X·Y·Z directions each 3 times |
| | Weight (g) | 300 |

Suffix code

| Model | Code | Content |
|--------|--------------------------|---------------------|
| HP3- | <input type="checkbox"/> | Digital Scale Meter |
| Option | 0 | No communication |
| | 1 | RS232 |
| | 2 | RS485 |

HLP1

Specifications

| | | | |
|--------------------------------|--|--|---------------------------|
| Model | | HLP1 | |
| Appearance | |  | |
| W X H X D (mm) | | 48.0×24.0×37.1 | |
| Input | Input specifications | 4~20 mA d.c. | |
| | Max. display digits | 4 Digits (-1999 ~ 9999) | |
| | Sampling cycle | Selection by parameter (0.5, 1, 2, 3, 4, 5 sec) | |
| | Input correction | ±3 % of FS | |
| Performance | Accuracy | ±0.3 % of FS ±1 Digit | |
| | Insulation resistance | 100 MΩ (500 V d.c.) | |
| | Dielectric strength | 2,300V a.c. 50/60 Hz for 1 min | |
| Functions | | Default set value | Setting range |
| | High limit scale setting | 2000 | -1999 ~ 9999 |
| | Low limit scale setting | 0400 | |
| | Decimal point setting | 00.00 | 00.00, 000.0, 0000, 0.000 |
| | Display cycle setting | 0.5 s | 0.5, 1, 2, 3, 4, 5 s |
| | Error display range setting | 5 % | 0, 1, 2, 3, 4, 5 % |
| | High limit correction of display value | 0 | -199 ~ 199 |
| | Low limit correction of display value | 0 | |
| | Measurement delay time setting | 0 | 0 ~ 30 s |
| | Flashing function setting | OFF | ON, OFF |
| Parameter lock setting | OFF | ON, OFF | |
| Power voltage | | Non-voltage type | |
| Ambient temperature & humidity | | -5 ~ 50 °C, 20 ~ 90 % RH (Without condensation) | |
| Storage temperature | | -25 ~ 70 °C | |
| Vibration resistance | | 10 ~ 55 Hz single amplitude X·Y·Z each direction 2 hours | |
| Shock resistance | | 300 m/s ² , X·Y·Z each direction 3 times | |

New product
Multi-pulse
meter

Small LCD
Pulse meter

Multi
Pulse meter

New product
Multi Panel
meter

Digital
Multi Panel
meter

Digital
Wattmeter

Digital
Voltage/
Ammeter

Digital
Frequency
meter

Digital
Scale meter

Digital
Small type
DC indicator

PANEL METERS

BA1

Specifications

| Model | | BA1-D□□ | BA1-D□□A |
|--------------------------------|-----------------------|---|--------------|
| Appearance | |  | |
| WXHxD(mm) | | 48.0×24.0×60.0 | |
| Input | Input signal | Input voltage, current, instrument signal input (4 - 20 mA d.c. or 1 - 5 V d.c.) | |
| | A / D converter | Double integration method | |
| | Sampling cycle | 300 ms | |
| | Response speed | Approx. 2 sec (max. range) | |
| | Max. display digits | ±1999 | |
| Performance | Accuracy | DC : ±0.2 % FS ±1 Digit | |
| | Insulation resistance | Min. 100 MΩ (500 V d.c.) | |
| | Dielectric strength | 1500 V a.c. for 1 min (between power terminals and input terminals) | |
| Functions | Decimal point display | 10 ¹ , 10 ² , 10 ³ display by rear terminal connection | |
| | Polarity display | If the input signal is reversed, "-" is displayed automatically | |
| | Range over display | Displayed as "1 □□□" | |
| | Range below display | Displayed as "-1□□□" | |
| | Display | 7 segment LED | |
| Power voltage | | 5 V d.c. | 12-24 V d.c. |
| Voltage fluctuation rate | | ±10 % of power voltage | |
| Power consumption | | Approx. 3 W | Approx. 5 W |
| Ambient temperature & humidity | | 0 ~ 50 °C, 35 ~ 85 % RH (without condensation) | |
| Storage temperature | | -10 ~ 70 °C | |
| Vibration resistance | | 10 ~ 55 Hz 편진폭 X·Y·Z each direction 2 hours | |
| Shock resistance | | 300 m/s ² , X·Y·Z each direction 3 times | |

Suffix code

| Model | Code | Content |
|---------------|---------|-----------------------------|
| BA1- | □ □ □ □ | Digital Voltmeter / Ammeter |
| Input | D 10 | DC voltage (DC) |
| | D 20 | DC current (DC) |
| | D 11 | DC voltmeter (1-5 V d.c.) |
| | D 21 | DC ammeter (4-20 mA d.c.) |
| Range code | | Refer to measuring range |
| Power voltage | | 5 V d.c. |
| | A | 12-24 V d.c. |

Measuring range

● DC voltage

| Model | Measuring range | Resolution | Input impedance | Max. allowable input voltage |
|----------|-----------------|------------|-----------------|------------------------------|
| BA1-D101 | 199.9 mV | 100 μV | 100 kΩ | 70 V |
| BA1-D102 | 1.999 V | 1 mV | 1 MΩ | 100 V |
| BA1-D103 | 19.99 V | 10 mV | 1 MΩ | 250 V |
| BA1-D104 | 199.9 V | 100 mV | 10 MΩ | 300 V |
| BA1-D111 | 1-5Vd.c. | 50.0 | 100 kΩ | 100 V |
| BA1-D112 | | 100.0 | 100 kΩ | 100 V |
| BA1-D113 | | 199.9 | 100 kΩ | 100 V |

※ Accuracy: ± 0.2% of present value ± 1 digit (23 °C ± 5 °C)

● DC current

| Model | Measuring range | Resolution | Input impedance | Max. allowable input voltage |
|----------|-----------------|------------|--|------------------------------|
| BA1-D201 | 199.9 μA | 0.1 μA | 1 kΩ | 1 mA |
| BA1-D202 | 1.999 mA | 1 μA | 100 Ω | 50 mA |
| BA1-D203 | 19.99 mA | 10 μA | 10 Ω | 150 mA |
| BA1-D204 | 199.9 mA | 100 μA | 1 Ω | 300 mA |
| BA1-D205 | 1.999 A | 1 mA | Shunt use (Secondary voltage 50 mV) | |
| BA1-D206 | 19.99 A | 10 mA | | |
| BA1-D207 | 199.9 A | 100 mA | | |
| BA1-D208 | 1999 A | 1 A | | |
| BA1-D211 | 4-20mA d.c. | 50.0 | 25 Ω | 150 mA |
| BA1-D212 | | 100.0 | 50 Ω | 150 mA |
| BA1-D213 | | 199.9 | 100 Ω | 150 mA |

※ Accuracy: ± 0.2% of present value ± 1 digit (23 °C ± 5 °C)

EM310

Specifications

| Model | EM310 |
|------------------------|--|
| Appearance |  |
| Power voltage | 24 V d.c. 500 mA |
| Communication method | Asynchronous serial communication (RS232C) |
| Communication speed | 38,400 bps |
| Communication distance | Max. 5 m |
| Setting method | Front switch operation method |
| Storage medium | USB memory stick |
| File system | FAT16, 32 support |
| Internal memory | 32 Mbyte (Non-volatile) |
| Applicable products | TH500, TH300, TD500, TS500 (However, TD500 and TH300 only support RS232 products) |

CV250

Specifications



| Model | CV250 |
|--------------------------------|---|
| Appearance |  |
| Power voltage | 100 / 240 V a.c. 50/60 Hz |
| Power consumption | Approx. 3 VA |
| Input signal | RTD : Pt100 Ω (IEC751), DRY / WET each 1 year |
| Measuring range | Temperature : 0 ~ 100 °C, Humidity : 0 ~ 100 % RH |
| Accuracy | Temperature : ±0.5 %, Humidity : ±1 % RH |
| Output signal | Individual temperature/humidity output (Current by suffix code / output selection), 4 - 20 mA d.c. (load resistance max. 600 Ω), 1 - 5 V d.c. (load resistance 1 kΩ min) |
| Output compensation | ±5 % (Offset correction by variable resistor) |
| Insulation resistance | Min. 20 MΩ (500 V d.c.) |
| Dielectric strength | 2500 V a.c. (power terminal-signal input/output terminal) |
| Ambient temperature & humidity | 0 ~ 50 °C, 35 ~ 85 % RH (without condensation) |
| Storage temperature | -25 ~ 65 °C |
| Weight (g) | 300 |

Suffix code

| Model | Code | Content |
|---------------|------|----------------------------------|
| CV250- | □ | Temperature / Humidity Converter |
| Output signal | C | 4-20 mA d.c. |
| | V | 1-5 V d.c. |



CV310 / 300

Specifications

| Model | CV310 | CV300 |
|--------------------------|--|---|
| Appearance |  |  |
| W×H×D(mm) | 49.3×33.0×17.8 | 52.0 x 90.0 x 20.0 |
| Power voltage | 9-30 V d.c. | 9 V, 300 mA d.c. Adapter (1.3 Ø DC Jack) |
| Max. communication speed | 460800 bps | 2400 ~ 115200 bps |
| Communication distance | Max. 1.2 km , 256 node connectable | Max. 1.5 km , 256 node connectable |
| Safety | Built-in 2kV protection device for RS232 and RS485 / RS422 | 1/2nd circuit insulation, Surge Protection Device Built-in, Automatically generate ±15 KV ESD Protection Line Drive signals |
| Function setting | 2-wire / 4-wire, built-in terminal resistor use/ not use, full / half-duplex | Two-line/four-line, built-in termination resistance can be set, such as oil, zero, full/half duplex, etc. |
| Setting switch | 4 Pin Dip Switch | 6 Pin Piano Type Dip-Switch |
| Weight (g) | 24 | Body : 60, Adapter : 300 |

HMCE-103

Specifications

| Model | HMCE-103 |
|------------------------|---|
| Appearance |  |
| CPU | PIC32MX695F512L |
| Memory | SRAM : 128 Kbit, Flash : 512 Kbit |
| Input voltage | 5 V d.c. (±10 %) |
| Max. Current | Max. under 250 mA |
| RS232 communication | <ul style="list-style-type: none"> ● Data communication / serial console male DB9 serial port , ● Communication speed : 2400 ~ 115200 bps, ● Flow control : None, ● Signal : TX, RX, GND 신호 : TX, RX, GND |
| RS485 communication | <ul style="list-style-type: none"> ● 2-wire half-duplex method for data communication, ● Communication speed : 2400 ~ 115200 bps, ● Flow control: DE/RE, ● Signal : TX+, TX- |
| RS-422 communication | <ul style="list-style-type: none"> ● 4-wire full-duplex method for data communication, ● Communication speed : 2400 ~ 115200 bps, ● Flow control: None, ● Signal : TX+, RX+, TX-, RX- |
| Ethernet communication | <ul style="list-style-type: none"> ● 10/100 Base-T Ethernet (RJ-45 Connector), ● Fluid IP support, ● It is possible to access many clients (up to 3), ● ARP, IP/ICMP, TCP, Telnet, DHCP |
| Ambient setting | Telnet or serial console interface |
| LED | ● Power input display, ● Activation status display |
| Ambient temperature | -10 ~ 60 °C |
| Storage temperature | -30 ~ 80 °C |
| Certification standard |  KCC-REM-NUX-HMCE-103 |
| Warranty period | 1 Year |
| Weight (g) | 74 |

Electrode Level switch

Electrode Holder

Data storage device, Communication converter, Temperature and humidity converter

Floatless level switches / Electrode holder

FS-3A

Specifications

| Model | FS-3 A(High sensitivity) | FS-3 A(Low sensitivity) |
|---|---|-------------------------|
| Appearance |  | |
| Power voltage | 110 V a.c. 50/60 Hz / 220 V a.c. 50/60 Hz | |
| Allowable voltage fluctuation range | ±10 % of power voltage | |
| Inter-electrode voltage (secondary voltage) | 24 V a.c. | 8 V a.c. |
| Power consumption | Approx. 3.2 VA | |
| Response time | 80 ms max. for operation, 160 ms max. for return | |
| Inter-electrode operation resistance | 0 - Approx. 27 KΩ | 0 - Approx. 7 KΩ |
| Inter-electrode return resistance | Approx. 38 KΩ - ∞ Ω | Approx. 15 KΩ - ∞ Ω |
| Control output | Relay contact outputs: (1c): 250 V a.c 5 A (resistive load) | |
| Insulation resistance | Min. 100 MΩ (500 V d.c Mega), conductive and exposed unfilled metal part | |
| Dielectric strength | 2000 V a.c 50/60 Hz for 1 min (1st terminal - 2nd terminal) | |
| Vibration resistance | 10 - 55 Hz (1 minute cycle) single amplitude: 0.76 mm X, Y, Z each direction 2 hours | |
| Shock resistance | 300 m/s² | |
| Life | Mechanical : min. 5 million times (relay type), Electrical : 500,000 times min (resistive load) | |
| Ambient temperature & humidity | -10 ~ 50 °C, 35 ~ 85 % RH (without condensation) | |

HY-ER3

Specifications

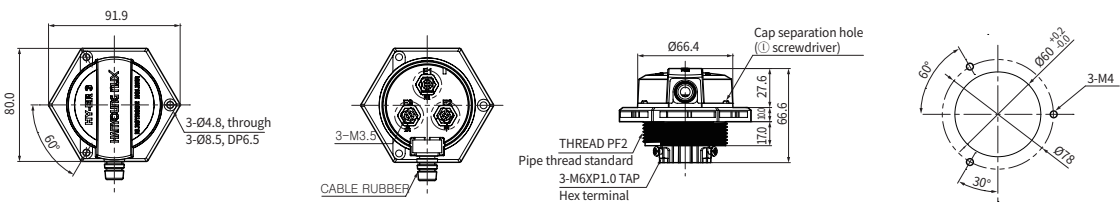
| Appearance | Dimension |
|---|--|
|  |  <p>91.9 80.0 3-Ø4.8, through 3-Ø8.5, DP6.5 60° 3-M3.5 CABLE RUBBER Ø66.4 Cap separation hole (1) screwdriver 27.6 17.0 66.6 THREAD PF2 Pipe thread standard 3-M6XP1.0 TAP Hex terminal 60° 30° Ø18 3-M4</p> |

Usage example

- Example of Water Supply connection (with FS-3A)

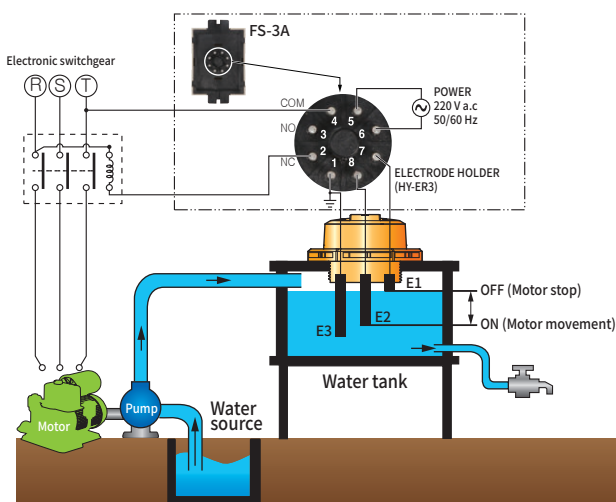

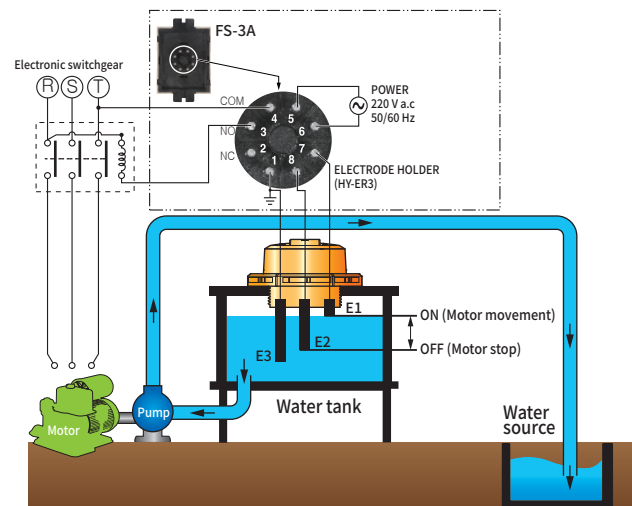

- Example of Drain connection (with FS-3A)





UP series

Specifications

● Inductive DC 3 wire type **CE**

| Model | NPN | UP8RM-1.5N□□ | UP8RD-2N□□ | UP12RM-2N□□ | UP12RD-4N□□ | |
|--------------------------------|--|--------------|---|---|---|--------|
| | PNP | UP8RM-1.5P□□ | UP8RD-2P□□ | UP12RM-2P□□ | UP12RD-4P□□ | |
| Appearance |  | |  | |  | |
| Shield | Shield | | Non shield | | Non shield | |
| Standard sensing object (mm) | Iron 8 X 8 X 1 | | | | Iron 12 X 12 X 1 | |
| Sensing distance | 1.5 mm | | 2 mm | | 4 mm | |
| Setting distance | 0 ~ 1.2 mm | | 0 ~ 1.6 mm | | 0 ~ 3.2 mm | |
| Hysteresis | Less than 10% of sensing distance | | | | | |
| Response frequency | 800 Hz | | | 800 Hz | | 400 Hz |
| Power voltage | 12-24 V d.c. (Usable voltage range 5 - 35 V d.c.) | | | | | |
| Control output | 200 mA max (Resistive load) | | | | | |
| Residual voltage | Max. 1.5 V | | | | | |
| Current consumption | Max. 6 mA | | | | | |
| Operation indication | Red LED | | | | | |
| Protection circuit | Power reversely connected protective circuit, surge protective circuit and over current protective circuit are built-in. | | | | | |
| Ambient temperature & humidity | -25 ~ 70 °C (Less than ±10 % of sensing distance at temperature 20 °C), 35 ~ 85 % RH | | | | | |
| Insulation resistance | Min. 50 MΩ (500 V d.c. mega standard) | | | | | |
| Dielectric strength | 2000 V a.c. 50/60 Hz for 1 min (between the recharging part and case) | | | | | |
| Vibration resistance | 10 - 55 Hz (1 min cycle, double amplitude : 1.5 mm 2 hours for each of X, Y and Z directions) | | | | | |
| Shock resistance | 500 m/s ² 3 times to each of X, Y and Z directions | | | | | |
| Degree of protection | IP67 (IEC 60529) | | | | | |
| Connection structure | ● Cable type (standard cable length 2 m), ● Relay connector type, ● Connector type | | | | | |
| Color | NPN : green, PNP : navy | | | | | |
| Material | ● Case : stainless, ● Sensing surface : PBT, ● Cable holder : polyester elastomer | | | ● Case : brass (chrome plating), ● Sensing surface: PBT, ● Cable holder : polyester elastomer | | |
| Weight (g) | Cable | 60 | 60 | 70 | 70 | |
| | Relay Connector | None | None | 30 | 30 | |
| | Connector | None | None | 30 | 30 | |

● Inductive DC 3 wire type **CE**

| Model | NPN | UP18RM-5N□□ | UP18RD-8N□□ | UP18RLM-5N□□ | UP18RLD-8N□□ | |
|--------------------------------|--|-------------|---|--------------|---|--|
| | PNP | UP18RM-5P□□ | UP18RD-8P□□ | UP18RLM-5P□□ | UP18RLD-8P□□ | |
| Appearance |  | |  | |  | |
| Shield | Shield | | Non shield | | Non shield | |
| Standard sensing object(mm) | Iron 18×18×1 | | Iron 25×25×1 | | Iron 25×25×1 | |
| Sensing distance | 5 mm | | 8 mm | | 8 mm | |
| Setting distance | 0 ~ 4 mm | | 0 ~ 6.4 mm | | 0 ~ 6.4 mm | |
| Hysteresis | Less than 10% of sensing distance | | | | | |
| Response frequency | 350 Hz | | 200 Hz | | 200 Hz | |
| Power voltage | 12-24 V d.c. (Usable voltage range 5 - 35 V d.c.) | | | | | |
| Control output | 200 mA max (Resistive load) | | | | | |
| Residual voltage | Max. 1.5 V | | | | | |
| Current consumption | Max. 6 mA | | | | | |
| Operation indication | Red LED | | | | | |
| Protection circuit | Power reversely connected protective circuit, surge protective circuit and over current protective circuit are built-in. | | | | | |
| Ambient temperature & humidity | -25 ~ 70 °C (Less than ±10 % of sensing distance at temperature 20 °C), 35 ~ 85 % RH | | | | | |
| Insulation resistance | Min. 50 MΩ (500 V d.c. mega standard) | | | | | |
| Dielectric strength | 2,000 V a.c. 50/60 Hz for 1 min (Between the recharging part and case) | | | | | |
| Vibration resistance | 10 - 55 Hz (1 min cycle, double amplitude : 1.5 mm 2 hours for each of X, Y and Z directions) | | | | | |
| Shock resistance | 500 m/s ² 3 times to each of X, Y and Z directions | | | | | |
| Degree of protection | IP67 (IEC 60529) | | | | | |
| Connection structure | ● Cable type (standard cable length 2 m), ● Relay connector type, ● Connector type | | | | | |
| Color | ● NPN : green ● PNP : navy | | | | | |
| Material | ● Case : brass (chrome plating), ● Sensing surface : PBT, ● Cable holder : polyester elastomer | | | | | |
| Weight (g) | Cable | 120 | 120 | 140 | 140 | |
| | Relay Connector | 80 | 80 | 100 | 100 | |
| | Connector | 60 | 60 | 80 | 80 | |

Columnar

Square



Thin

Capacitive Type



Connector Cable

PROXIMITY SENSORS



● Inductive DC 3 wire type

| Model | NPN | UP30RM-10N□□ | UP30RD-15N□□ | UP30RLM-10N□□ | UP30RLD-15N□□ | |
|--------------------------------|---|--------------|---|---------------|---|--|
| | PNP | UP30RM-10P□□ | UP30RD-15P□□ | UP30RLM-10P□□ | UP30RLD-15P□□ | |
| Appearance |  | |  | |  | |
| Shield | Shield | | Non shield | | Shield | |
| Standard sensing object (mm) | Iron 30×30×1 | | Iron 45×45×1 | | Iron 30×30×1 | |
| Sensing distance | 10 mm | | 15 mm | | 10 mm | |
| Setting distance | 0 ~ 8 mm | | 0 ~ 12 mm | | 0 ~ 8 mm | |
| Hysteresis | Less than 10% of sensing distance | | | | | |
| Response frequency | 250 Hz | | 100 Hz | | 250 Hz | |
| Power voltage | 12-24 V d.c. (Usable voltage range 5 - 35 V d.c.) | | | | | |
| Control output | 200 mA max (Resistive load) | | | | | |
| Residual voltage | Max. 1.5 V | | | | | |
| Current consumption | Max. 6 mA | | | | | |
| Operation indication | Red LED | | | | | |
| Protection circuit | ● Power reverse connection protection circuit, ● Surge protection circuit, ● Over-current protection circuit built in | | | | | |
| Ambient temperature & humidity | -25 ~ 70 °C (Less than ±10 % of sensing distance at temperature 20 °C), 35 ~ 85 %RH | | | | | |
| Insulation resistance | Min. 50 MΩ (500 V d.c. mega standard) | | | | | |
| Dielectric strength | 2000 V a.c. 50/60 Hz for 1 min (between the recharging part and case) | | | | | |
| Vibration resistance | 10 - 55 Hz (1 min cycle, double amplitude : 1.5 mm 2 hours for each of X, Y and Z directions) | | | | | |
| Shock resistance | 500 m/s ² 3 times to each of X, Y and Z directions | | | | | |
| Degree of protection | IP67 (IEC 60529) | | | | | |
| Connection structure | ● Cable type (standard cable length 2 m), ● Relay connector type, ● Connector type | | | | | |
| Color | ● NPN : green ● PNP : navy | | | | | |
| Material | ● Case : brass (chrome plating) ● Sensing surface : PBT ● Cable holder : polyester elastomer | | | | | |
| Weight (g) | Cable | 170 | 170 | 220 | 220 | |
| | Relay Connector | 130 | 130 | 180 | 180 | |
| | Connector | 150 | 150 | 200 | 200 | |

● Inductive DC 2 wire type (Polarity / No polarity)

| Model | Polar | UP8RM-1.5T□□ | UP8RD-2T□□ | UP12RM-2T□□ | UP12RD-4T□□ | |
|--------------------------------|---|--------------|---|---|---|--|
| | No polarity | - | - | UP12RM-2U□□ | UP12RD-4U□□ | |
| Appearance |  | |  | |  | |
| Shield | Shield | | Non shield | | Shield | |
| Standard sensing object (mm) | Iron 8×8×1 | | Iron 8×8×1 | | Iron 12×12×1 | |
| Sensing distance | 1.5 mm | | 2 mm | | 2 mm | |
| Setting distance | 0 ~ 1.2 mm | | 0 ~ 1.6 mm | | 0 ~ 1.6 mm | |
| Hysteresis | Less than 10% of sensing distance | | | | | |
| Response frequency | 800 Hz | | 800 Hz | | 800 Hz | |
| Power voltage | 12-24 V d.c. (Usable voltage range 5 - 30 V d.c.) | | | | | |
| Control output | 100 mA max (Resistive load) | | | | | |
| Residual voltage | ● T(Polarity) : max. 3.5 V ● U(No polarity) : max. 5 V | | | | | |
| Leakage current | Max. 1 mA | | | | | |
| Operation indication | Red LED | | | | | |
| Protection circuit | Surge protective circuit and over current protective circuit are built-in. | | | | | |
| Ambient temperature & humidity | -25 ~ 70 °C (Less than ±10 % of sensing distance at temperature 20 °C), 35 ~ 85 % RH | | | | | |
| Insulation resistance | Min. 50 MΩ (500 V d.c. mega standard) | | | | | |
| Dielectric strength | 2,000 V a.c. 50/60 Hz for 1 min (between the recharging part and case) | | | | | |
| Vibration resistance | 10 - 55 Hz (1 min cycle, double amplitude : 1.5 mm 2 hours for each of X, Y and Z directions) | | | | | |
| Shock resistance | 500 m/s ² 3 times to each of X, Y and Z directions | | | | | |
| Degree of protection | IP67 (IEC 60529) | | | | | |
| Connection structure | ● Cable type (standard cable length 2 m), ● Relay connector type, ● Connector type | | | | | |
| Color | ● NO : green ● NC : navy | | | | | |
| Material | ● Case: stainless ● Sensing surface: PBT ● Cable holder : polyester elastomer | | | ● Case: brass (chrome plating) ● Sensing surface: PBT ● Cable holder : polyester elastomer | | |
| Weight (g) | Cable | 60 | | 70 | | |
| | Relay Connector | None | | 30 | | |
| | Connector | None | | 30 | | |

● Inductive DC 2 wire type (Polarity / No polarity)

| Model | Polar | UP18RM-5T□□ | UP18RD-8T□□ | UP18RLM-5T□□ | UP18RLD-8T□□ | |
|--------------------------------|---|-------------|---|--------------|---|--|
| | No polarity | UP18RM-5U□□ | UP18RD-8U□□ | UP18RLM-5U□□ | UP18RLD-8U□□ | |
| Appearance |  | |  | |  | |
| Shield | Shield | | Non shield | | Shield | |
| Standard sensing object (mm) | Iron 18×18×1 | | Iron 25×25×1 | | Iron 18×18×1 | |
| Sensing distance | 5 mm | | 8 mm | | 5 mm | |
| Setting distance | 0 ~ 4 mm | | 0 ~ 6.4 mm | | 0 ~ 4 mm | |
| Hysteresis | Less than 10% of sensing distance | | | | | |
| Response frequency | 350 Hz | | 200 Hz | | 350 Hz | |
| Power voltage | 12-24 V d.c. (Usable voltage range 5 - 30 V d.c.) | | | | | |
| Control output | 100 mA max (Resistive load) | | | | | |
| Residual voltage | ● T (Polarity) : max. 3.5 V, ● U (no polarity): max. 5 V | | | | | |
| Leakage current | Max. 1 mA | | | | | |
| Operation indication | Red LED | | | | | |
| Protection circuit | Surge protective circuit and over current protective circuit are built-in. | | | | | |
| Ambient temperature & humidity | -25 ~ 70 °C (Less than ±10 % of sensing distance at temperature 20 °C), 35 ~ 85 % RH | | | | | |
| Insulation resistance | Min. 50 MΩ (500 V d.c. mega standard) | | | | | |
| Dielectric strength | 2,000 V a.c. 50/60 Hz for 1 min (between the recharging part and case) | | | | | |
| Vibration resistance | 10 - 55 Hz (1 min cycle, double amplitude : 1.5 mm 2 hours for each of X, Y and Z directions) | | | | | |
| Shock resistance | 500 m/s ² 3 times to each of X, Y and Z directions | | | | | |
| Degree of protection | IP67 (IEC 60529) | | | | | |
| Connection structure | ● Cable type (standard cable length 2 m), ● Relay connector type, ● Connector type | | | | | |
| Color | ● NO : green ● NC : navy | | | | | |
| Material | ● Case : brass (chrome plating) ● Sensing surface : PBT ● Cable holder : polyester elastomer | | | | | |
| Weight (g) | Cable | 120 | 120 | 140 | 140 | |
| | Relay Connector | 80 | 80 | 100 | 100 | |
| | Connector | 60 | 60 | 80 | 80 | |

Columnar



Square

Thin

Capacitive Type



Connector Cable

● Inductive DC 2 wire type (Polarity / No polarity)



| Model | Polar | UP30RM-10T□□ | UP30RD-15T□□ | UP30RLM-10T□□ | UP30RLD-15T□□ | |
|--------------------------------|---|--------------|---|---------------|---|--|
| | No polarity | UP30RM-10U□□ | UP30RD-15U□□ | UP30RLM-10U□□ | UP30RLD-15U□□ | |
| Appearance |  | |  | |  | |
| Shield | Shield | | Non shield | | Shield | |
| Standard sensing object (mm) | Iron 30×30×1 | | Iron 45×45×1 | | Iron 30×30×1 | |
| Sensing distance | 10 mm | | 15 mm | | 10 mm | |
| Setting distance | 0 ~ 8 mm | | 0 ~ 12 mm | | 0 ~ 8 mm | |
| Hysteresis | Less than 10% of sensing distance | | | | | |
| Response frequency | 250 Hz | | 100 Hz | | 250 Hz | |
| Power voltage | 12-24 V d.c. (Usable voltage range 5 - 30 V d.c.) | | | | | |
| Control output | 100 mA max (Resistive load) | | | | | |
| Residual voltage | ● T (polarity): max. 3.5 V, ● U (no polarity): max. 5 V | | | | | |
| Leakage current | Max. 1 mA | | | | | |
| Operation indication | Red LED | | | | | |
| Protection circuit | Surge protective circuit and over current protective circuit are built-in. | | | | | |
| Ambient temperature & humidity | -25 ~ 70 °C (Less than ±10 % of sensing distance at temperature 20 °C), 35 ~ 85 % RH | | | | | |
| Insulation resistance | Min. 50 MΩ (500 V d.c. mega standard) | | | | | |
| Dielectric strength | 2,000 V a.c. 50/60 Hz for 1 min (between the recharging part and case) | | | | | |
| Vibration resistance | 10 - 55 Hz (1 min cycle, double amplitude : 1.5 mm 2 hours for each of X, Y and Z directions) | | | | | |
| Shock resistance | 500 m/s ² 3 times to each of X, Y and Z directions | | | | | |
| Degree of protection | IP67 (IEC 60529) | | | | | |
| Connection structure | ● Cable type (standard cable length 2 m), ● Relay connector type, ● Connector type | | | | | |
| Color | ● NO : green ● NC : navy | | | | | |
| Material | ● Case : brass (chrome plating) ● Sensing surface : PBT ● Cable holder: polyester elastomer | | | | | |
| Weight (g) | Cable | 170 | | 220 | | |
| | Relay Connector | 130 | | 180 | | |
| | Connector | 150 | | 200 | | |

PROXIMITY SENSORS

● Inductive AC 2 wire type **CE**

| Model | UP12RM-2A□□ | UP12RD-4A□□ | |
|--------------------------------|--|---|----|
| Appearance |  |  | |
| Shield | Shield | Non shield | |
| Standard sensing object (mm) | Iron 12×12×1 | | |
| Sensing distance | 2 mm | 4 mm | |
| Setting distance | 0 ~ 1.6 mm | 0 ~ 3.2 mm | |
| Hysteresis | Less than 10 % of sensing distance | | |
| Response frequency | 20 Hz | | |
| Power voltage | 100-240 V a.c. 50-60 Hz (Usable voltage range 90 - 250 V a.c. 50-60 Hz) | | |
| Control output | 200 mA max (Resistive load) | | |
| Residual voltage | Max. 10 V | | |
| Leakage current | Max. 2.2 mA | | |
| Operation indication | Red LED | | |
| Protection circuit | Surge protective circuit built-in. | | |
| Ambient temperature & humidity | -25 ~ 70 °C (less than ±10 % of sensing distance at temperature 20 °C), 35 ~ 85 %RH | | |
| Insulation resistance | Min. 50 MΩ (500 V d.c. mega standard) | | |
| Dielectric strength | 2,000 V a.c. 50/60 Hz for 1 min (between the recharging part and case) | | |
| Vibration resistance | 10 - 55 Hz (1 min cycle, double amplitude: 1.5 mm 2 hours for each of X, Y and Z directions) | | |
| Shock resistance | 500 m/s ² 3 times to each of X, Y and Z directions | | |
| Degree of protection | IP67 (IEC 60529) | | |
| Connection structure | ● Cable type (standard cable length 2 m), ● Relay connector type, ● Connector type | | |
| Color | ● NO : green ● NC : navy | | |
| Material | ● Case : brass (chrome plating) ● Sensing surface : PBT ● Cable holder : polyester elastomer | | |
| Weight (g) | Cable | 70 | 70 |
| | Relay Connector | 30 | 30 |
| | Connector | 30 | 30 |

● Inductive AC 2 wire type **CE**

| Model | UP18RM-5A□□ | UP18RD-8A□□ | UP18RLM-5A□□ | UP18RLD-8A□□ |
|--------------------------------|--|---|--|---|
| Appearance |  |  |  |  |
| Shield | Shield | Non shield | Shield | Non shield |
| Standard sensing object (mm) | Iron 18×18×1 | Iron 25×25×1 | Iron 18×18×1 | Iron 25×25×1 |
| Sensing distance | 5 mm | 8 mm | 5 mm | 8 mm |
| Setting distance | 0 ~ 4 mm | 0 ~ 6.4 mm | 0 ~ 4 mm | 0 ~ 6.4 mm |
| Hysteresis | Less than 10 % of sensing distance | | | |
| Response frequency | 20 Hz | | | |
| Power voltage | 100-240 V a.c. 50-60 Hz (Usable voltage range 90 - 250 V a.c. 50-60 Hz) | | | |
| Control output | Max. 200 mA (resistive load) | | | |
| Residual voltage | Max. 10 V | | | |
| Leakage current | Max. 2.2 mA | | | |
| Operation indication | Red LED | | | |
| Protection circuit | Surge protective circuit built-in. | | | |
| Ambient temperature & humidity | -25 ~ 70 °C (less than ±10 % of sensing distance at temperature 20 °C), 35 ~ 85 %RH | | | |
| Insulation resistance | Min. 50 MΩ (500 V d.c. mega standard) | | | |
| Dielectric strength | 2000 V a.c. 50/60 Hz for 1 min (between the recharging part and case) | | | |
| Vibration resistance | 10 - 55 Hz (1 min cycle, double amplitude: 1.5 mm 2 hours for each of X, Y and Z directions) | | | |
| Shock resistance | 500 m/s ² 3 times to each of X, Y and Z directions | | | |
| Degree of protection | IP67 (IEC 60529) | | | |
| Connection structure | ● Cable type (standard cable length 2 m), ● Relay connector type, ● Connector type | | | |
| Color | ● NO : green ● NC : navy | | | |
| Material | ● Case : brass (chrome plating) ● Sensing surface : PBT ● Cable holder : polyester elastomer | | | |
| Weight (g) | Cable | 120 | 140 | 140 |
| | Relay Connector | 80 | 100 | 100 |
| | Connector | 60 | 80 | 80 |

● Inductive AC 2 wire type

| Model | UP30RM-10A□□ | UP30RD-15A□□ | UP30RLM-10A□□ | UP30RLD-15A□□ | |
|--------------------------------|--|---|---|---|-----|
| Appearance |  |  |  |  | |
| Shield | Shield | Non shield | Shield | Non shield | |
| Standard sensing object (mm) | Iron 30×30×1 | Iron 45×45×1 | Iron 30×30×1 | Iron 45×45×1 | |
| Sensing distance | 10 mm | 15 mm | 10 mm | 15 mm | |
| Setting distance | 0 ~ 8 mm | 0 ~ 12 mm | 0 ~ 8 mm | 0 ~ 12 mm | |
| Hysteresis | Less than 10 % of sensing distance | | | | |
| Response frequency | 20 Hz | | | | |
| Power voltage | 100-240 V a.c. 50-60 Hz (Usable voltage range 90 - 250 V a.c. 50-60 Hz) | | | | |
| Control output | Max. 200 mA (Resistive load) | | | | |
| Residual voltage | Max. 10 V | | | | |
| Leakage current | Max. 2.2 mA | | | | |
| Operation indication | Red LED | | | | |
| Protection circuit | Surge protective circuit built-in. | | | | |
| Ambient temperature & humidity | -25 ~ 70 °C (Less than ±10 % of sensing distance at temperature 20 °C), 35 ~ 85 % RH | | | | |
| Insulation resistance | Min. 50 MΩ (500 V d.c. mega standard) | | | | |
| Dielectric strength | 2000 V a.c. 50/60 Hz for 1 min (between the recharging part and case) | | | | |
| Vibration resistance | 10 - 55 Hz (1 min cycle, double amplitude: 1.5 mm 2 hours for each of X, Y and Z directions) | | | | |
| Shock resistance | 500 m/s ² 3 times to each of X, Y and Z directions | | | | |
| Degree of protection | IP67 (IEC 60529) | | | | |
| Connection structure | ● Cable type (standard cable length 2 m), ● Relay connector type, ● Connector type | | | | |
| Color | ● NO : green ● NC : navy | | | | |
| Material | ● Case : brass (chrome plating) ● Sensing surface : PBT ● Cable holder : polyester elastomer | | | | |
| Weight (g) | Cable | 170 | 170 | 220 | 220 |
| | Relay Connector | 130 | 130 | 180 | 180 |
| | Connector | 150 | 150 | 200 | 200 |

| |
|-----------------|
| Columnar |
| Square |
| Thin |
| Capacitive Type |
| Connector Cable |

■ Suffix code (Round type)

| Model | Code | Content |
|-----------------------|-------------|--|
| UP | □ □ □ □ □ □ | Inductive Type Proximity Sensor |
| Sensing area size | 8 | M8 |
| | 12 | M12 |
| | 18 | M18 |
| | 30 | M30 |
| Structure type | RM | Round type Shield |
| | RD | Round type Non Shield |
| | RLM | Long round type Shield (M8 and M12 are excluded) |
| | RLD | Long round type Non Shield (M8 and M12 are excluded) |
| Sensing distance | 1.5 | only with UP8-RM1.5 |
| | 2 | only with UP8-RD2, UP12-RM2 |
| | 4 | only with UP12-RD4 |
| | 5 | only with UP18-RM5, UP18-RLM5 |
| | 8 | only with UP18-RD8, UP18-RLD8 |
| | 10 | only with UP30-RM10, UP30-RLM10 |
| Power and output type | N | DC NPN output |
| | P | DC PNP output |
| | A | AC 2 wire type |
| | T | DC 2 wire type (polarity) |
| | U | DC 2 wire type (no polarity) ※ But M8 is excluded |
| Output state | A | Normal Open (N.O) |
| | C | Normal Close (N.C) |
| Connection structure | | None (Cable type) |
| | CR | Relay connector type |
| | C | Connector type |



※ Note) M8(8) type is cable type only.

PROXIMITY SENSORS





UP series

Specifications



● Inductive DC 3 wire type **CE**

| Model | NPN | UP12S-4N □ □ | UP18S-5N □ □ | UP18S-8N □ □ |
|--------------------------------|--|-----------------------------|---|--------------|
| | PNP | UP12S-4P □ □ | UP18S-5P □ □ | UP18S-8P □ □ |
| Appearance |  | |  | |
| Standard sensing object(mm) | Iron 12X12X1 | | Iron 18X18X1 | Iron 25X25X1 |
| Sensing distance | 4 mm | | 5 mm | 8 mm |
| Setting distance | 0 ~ 3.2 mm | | 0 ~ 4 mm | 0 ~ 6.4 mm |
| Hysteresis | Less than 10 % of sensing distance | | | |
| Response frequency | 800 Hz | | 350 Hz | 250 Hz |
| Power voltage | 12-24 V d.c. (Usable voltage range 5 - 35 V d.c.) | | | |
| Control output | Open/Close capacitance | 200 mA max (Resistive load) | | |
| | Residual voltage | Max. 1.5 V | | |
| Current consumption | Max. 6 mA | | | |
| Operation indication | Red LED | | | |
| Protective circuit | ● Power reversely connected protective circuit, ● Surge protective circuit and over current protective circuit are built-in. | | | |
| Degree of protection | IP67 (IEC 60529) | | | |
| Connection structure | ● Cable type (standard cable length 2 m), ● Relay connector type | | | |
| Ambient temperature & humidity | -25 ~ 70 °C (Less than ±10 % of sensing distance at temperature 20 °C), 35 ~ 85 %RH | | | |
| Insulation resistance | Min. 50 MΩ (500 V d.c. mega standard) | | | |
| Dielectric strength | 2000 V a.c. 50/60 Hz for 1 min (between the recharging part and case) | | | |
| Vibration resistance | 10 ~ 55 Hz (1 min cycle, double amplitude : 1.5 mm 2 hours for each of X, Y and Z directions) | | | |
| Shock resistance | 500 m/s ² 3 times to each of X, Y and Z directions | | | |
| Material | ● Case : PBT resin, ● Cable holder : polyester elastomer | | | |
| Weight(g) | Cable type | 45 | 60 | 60 |
| | Relay connector type | 15 | 20 | 20 |

● Inductive DC 3 wire type **CE**

| Model | NPN | UP25S-5N □ □ | UP25S-8N □ □ | UP25S-12N □ □ | UP30S-10N □ □ | UP30S-15N □ □ | UP40S-20N □ □ |
|--------------------------------|--|-----------------------------|---|------------------|---|------------------|---|
| | PNP | UP25S-5P □ □ | UP25S-8P □ □ | UP25S-12P □ □ | UP30S-10P □ □ | UP30S-15P □ □ | UP40S-20P □ □ |
| Appearance |  | |  | |  | |  |
| Standard sensing object(mm) | Iron 25 X 25 X 1 | Iron 30 X 30 X 1 | Iron 35 X 35 X 1 | Iron 30 X 30 X 1 | Iron 45 X 45 X 1 | Iron 60 X 60 X 1 | |
| Sensing distance | 5 mm | 8 mm | 12 mm | 10 mm | 15 mm | 20 mm | |
| Setting distance | 0 ~ 4 mm | 0 ~ 6.4 mm | 0 ~ 9.6 mm | 0 ~ 8 mm | 0 ~ 12 mm | 0 ~ 16 mm | |
| Hysteresis | Less than 10% of sensing distance | | | | | | |
| Response frequency | 350 Hz | 250 Hz | 200 Hz | 250 Hz | 100 Hz | 100 Hz | |
| Power voltage | 12-24 V d.c. (Usable voltage range 5 - 35 V d.c.) | | | | | | |
| Control output | Open/Close capacitance | 200 mA max (Resistive load) | | | | | |
| | Residual voltage | Max. 1.5 V | | | | | |
| Current consumption | Max. 6 mA | | | | | | |
| Operation indication | Red LED | | | | | | |
| Protective circuit | ● Power reversely connected protective circuit, ● Surge protective circuit and over current protective circuit are built-in. | | | | | | |
| Degree of protection | IP67 (IEC 60529) | | | | | | |
| Connection structure | ● Cable type (standard cable length 2 m), ● Relay connector type | | | | | | |
| Ambient temperature & humidity | -25 ~ 70 °C (less than ±10 % of sensing distance at temperature 20 °C), 35 ~ 85 % RH | | | | | | |
| Insulation resistance | Min. 50 MΩ (500 V d.c. mega standard) | | | | | | |
| Dielectric strength | 2,000V a.c. 50/60 Hz for 1 min (between the recharging part and case) | | | | | | |
| Vibration resistance | 10 ~ 55 Hz (1 min cycle, double amplitude : 1.5 mm 2 hours for each of X, Y and Z directions) | | | | | | |
| Shock resistance | 500 m/s ² 3 times to each of X, Y and Z directions | | | | | | |
| Material | ● Case : PBT resin, ● Cable holder : polyester elastomer | | | | | | |
| Weight(g) | Cable type | 80 | 80 | 80 | 90 | 90 | 110 |
| | Relay connector type | 40 | 40 | 40 | 60 | 60 | 80 |

● Inductive DC 2 wire type

| Model | NPN | UP12S-4T □ □ | UP18S-5T □ □ | UP18S-8T □ □ |
|--------------------------------|--|--|---|--------------|
| | PNP | UP12S-4U □ □ | UP18S-5U □ □ | UP18S-8U □ □ |
| Appearance |  | |  | |
| Standard sensing object(mm) | Iron 12X12X1 | | Iron 18X18X1 | Iron 25X25X1 |
| Sensing distance | 4 mm | | 5 mm | 8 mm |
| Setting distance | 0 ~ 3.2 mm | | 0 ~ 4 mm | 0 ~ 6.4 mm |
| Hysteresis | Less than 10 % of sensing distance | | | |
| Response frequency | 500 Hz | | 350 Hz | 250 Hz |
| Power voltage | 12-24 V d.c. (Usable voltage range 5 - 30 V d.c.) | | | |
| Control output | Open/Close capacitance | Max. 100 mA (resistive load) | | |
| | Residual voltage | ● T(Polarity) : max. 3.5 V ● U(No polarity) : max. 5 V | | |
| Current consumption | 1 mA or less | | | |
| Operation indication | Red LED | | | |
| Protective circuit | ● Power reversely connected protective circuit, ● Surge protective circuit and over current protective circuit are built-in. | | | |
| Degree of protection | IP67 (IEC 60529) | | | |
| Connection structure | ● Cable type (standard cable length 2 m), ● Relay connector type | | | |
| Ambient temperature & humidity | -25 ~ 70 °C (less than ±10 % of sensing distance at temperature 20 °C), 35 ~ 85 %RH | | | |
| Insulation resistance | Min. 50 MΩ (500 V d.c. mega standard) | | | |
| Dielectric strength | 2000 V a.c. 50/60 Hz for 1 min (between the recharging part and case) | | | |
| Vibration resistance | 10 ~ 55 Hz (1 min cycle, double amplitude: 1.5 mm 2 hours for each of X, Y and Z directions) | | | |
| Shock resistance | 500 m/s ² 3 times to each of X, Y and Z directions | | | |
| Material | ● Case : PBT resin, ● Cable holder : polyester elastomer | | | |
| Weight(g) | Cable type | 45 | 60 | 60 |
| | Relay connector type | 15 | 20 | 20 |

Columnar



Square

Thin

Capacitive Type



Connector Cable

● Inductive DC 2 wire type



| Model | NPN | UP25S-5T □ □ | UP25S-8T □ □ | UP25S-12T □ □ | UP30S-10T □ □ | UP30S-15T □ □ | UP40S-20T □ □ |
|--------------------------------|--|---|---|------------------|---|------------------|---------------|
| | PNP | UP25S-5U □ □ | UP25S-8U □ □ | UP25S-12U □ □ | UP30S-10U □ □ | UP30S-15U □ □ | UP40S-20U □ □ |
| Appearance |  | |  | |  | | |
| Standard sensing object(mm) | Iron 25 X 25 X 1 | Iron 30 X 30 X 1 | Iron 35 X 35 X 1 | Iron 30 X 30 X 1 | Iron 45 X 45 X 1 | Iron 60 X 60 X 1 | |
| Sensing distance | 5 mm | 8 mm | 12 mm | 10 mm | 15 mm | 20 mm | |
| Setting distance | 0 ~ 4 mm | 0 ~ 6.4 mm | 0 ~ 9.6 mm | 0 ~ 8 mm | 0 ~ 12 mm | 0 ~ 16 mm | |
| Hysteresis | Less than 10 % of sensing distance | | | | | | |
| Response frequency | 350 Hz | 250 Hz | 200 Hz | 250 Hz | 100 Hz | 100 Hz | |
| Power voltage | 12-24 V d.c. (usable voltage range 5 - 30 V d.c.) | | | | | | |
| Control output | Open/Close capacitance | Max. 100 mA (resistive load) | | | | | |
| | Residual voltage | ● T (polarity): max. 3.5 V ● U (Non polarity): max. 5 V | | | | | |
| Current consumption | Max. 1 mA | | | | | | |
| Operation indication | Red LED | | | | | | |
| Protective circuit | ● Power reversely connected protective circuit, ● Surge protective circuit and over current protective circuit are built-in. | | | | | | |
| Degree of protection | IP67 (IEC 60529) | | | | | | |
| Connection structure | ● Cable type (standard cable length 2 m), ● Relay connector type | | | | | | |
| Ambient temperature & humidity | -25 ~ 70 °C (less than ±10 % of sensing distance at temperature 20 °C), 35 ~ 85 %RH | | | | | | |
| Insulation resistance | Min. 50 MΩ (500 V d.c. mega standard) | | | | | | |
| Dielectric strength | 2000 V a.c. 50/60 Hz for 1 min (between the recharging part and case) | | | | | | |
| Vibration resistance | 10 ~ 55 Hz (1 min cycle, double amplitude : 1.5 mm 2 hours for each of X, Y and Z directions) | | | | | | |
| Shock resistance | 500 m/s ² 3 times to each of X, Y and Z directions | | | | | | |
| Material | ● Case : PBT resin, ● Cable holder : polyester elastomer | | | | | | |
| Weight(g) | Cable type | 80 | 80 | 80 | 90 | 90 | 110 |
| | Relay connector type | 40 | 40 | 40 | 60 | 60 | 80 |

PROXIMITY SENSORS

● Inductive AC 2 wire type

| Model | For AC | UP25S-5A □ □ | UP25S-8A □ □ | UP30S-10A □ □ |
|--------------------------------|------------------------|---|--------------|---|
| Appearance | |  | |  |
| Standard sensing object(mm) | | Iron 25 X 25 X 1 | | Iron 30 X 30 X 1 |
| Sensing distance | | 5 mm | 8 mm | 10 mm |
| Setting distance | | 0 ~ 4 mm | 0 ~ 6.4 mm | 0 ~ 8 mm |
| Hysteresis | | Less than 10% of sensing distance | | |
| Response frequency | | 20 Hz | | |
| Power voltage | | 100-240 V a.c. 50-60 Hz (Usable voltage range 90 - 250 V a.c.50-60 Hz) | | |
| Control output | Open/Close capacitance | Max. 200 mA (resistive load) | | |
| | Residual voltage | Max. 10 V a.c. | | |
| Current consumption | | Max. 2.2 mA | | |
| Operation indication | | Red LED | | |
| Protective circuit | | Surge protective circuit is built-in. | | |
| Degree of protection | | IP67 (IEC 60529) | | |
| Connection structure | | ● Cable type (standard cable length 2 m), ● Relay connector type | | |
| Ambient temperature & humidity | | -25 ~ 70 °C (less than ±10 % of sensing distance at temperature 20 °C), 35 ~ 85 %RH | | |
| Insulation resistance | | Min. 50 MΩ (500 V d.c. mega standard) | | |
| Dielectric strength | | 2,000 V a.c. 50/60 Hz for 1 min (between the recharging part and case) | | |
| Vibration resistance | | 10 ~ 55 Hz (1 min cycle, double amplitude : 1.5 mm 2 hours for each of X, Y and Z directions) | | |
| Shock resistance | | 500 m/s ² X·Y·Z 3 times to each of X, Y and Z directions | | |
| Material | | ● Case : PBT resin, ● Cable holder : polyester elastomer | | |
| Weight(g) | Cable type | 80 | 80 | 90 |
| | Relay connector type | 40 | 40 | 80 |

● Inductive AC 2 wire type

| Model | For AC | UP30S-15A □ □ | UP40S-20A □ □ |
|--------------------------------|------------------------|--|---|
| Appearance | |  |  |
| Standard sensing object(mm) | | Iron 45 X 45 X 1 | Iron 60 X 60 X 1 |
| Sensing distance | | 15 mm | 20 mm |
| Setting distance | | 0 ~ 12 mm | 0 ~ 16 mm |
| Hysteresis | | Less than 10% of sensing distance | |
| Response frequency | | 20 Hz | |
| Power voltage | | 100-240 V a.c. 50-60 Hz (Usable voltage range 90 - 250 V a.c.50-60 Hz) | |
| Control output | Open/Close capacitance | Max. 200 mA (resistive load) | |
| | Residual voltage | Max. 10 V a.c. | |
| Current consumption | | Max. 2.2 mA | |
| Operation indication | | Red LED | |
| Protective circuit | | Surge protective circuit is built-in. | |
| Degree of protection | | IP67 (IEC 60529) | |
| Connection structure | | ● Cable type (standard cable length 2 m), ● Relay connector type | |
| Ambient temperature & humidity | | -25 ~ 70 °C (less than ±10 % of sensing distance at temperature 20 °C), 35 ~ 85 %RH | |
| Insulation resistance | | Min. 50 MΩ (500 V d.c. mega standard) | |
| Dielectric strength | | 2,000 V a.c. 50/60 Hz for 1 min (between the recharging part and case) | |
| Vibration resistance | | 10 ~ 55 Hz (1 min cycle, double amplitude: 1.5 mm 2 hours for each of X, Y and Z directions) | |
| Shock resistance | | 500 m/s ² 3 times to each of X, Y and Z directions | |
| Material | | ● Case : PBT resin, ● Cable holder : polyester elastomer | |
| Weight(g) | Cable type | 90 | 110 |
| | Relay connector type | 60 | 80 |

Suffix code(Square type)

| Model | Code | Content |
|-----------------------|---|---|
| UP | <input type="checkbox"/> <input type="checkbox"/> <input type="checkbox"/> <input type="checkbox"/> <input type="checkbox"/> <input type="checkbox"/> <input type="checkbox"/> <input type="checkbox"/> | Inductive Type Proximity Sensor |
| Sensing area size | 12 | 12(W) × 12(H) mm |
| | 18 | 18(W) × 18(H) mm |
| | 25 | 25(W) × 25(H) mm |
| | 30 | 30(W) × 30(H) mm |
| | 40 | 40(W) × 40(H) mm |
| Structure type | S | Square type |
| Sensing distance | 2 | 2 mm (only with UP8S-2) |
| | 4 | 4 mm (only with UP12S-4) |
| | 5 | 5 mm (only with UP18S-5, UP25S-5) |
| | 8 | 8 mm (only with UP18S-8, UP25S-8) |
| | 10 | 10 mm (only with UP30S-10) |
| | 12 | 12 mm (only with UP25S-12) |
| | 15 | 15 mm (only with UP30S-15) |
| Power and output type | N | DC NPN output |
| | P | DC PNP output |
| | A | AC 2 wire type (but UP18S is excluded) |
| | T | DC 2 wire type (polarity) |
| | U | DC 2 wire type (no polarity) |
| Output state | A | Normal Open (NO) |
| | C | Normal Close (NC) |
| Sensing direction | | Detect Front side |
| | U | Detect upper side (only available with the square type UP18S) |
| Connection structure | | Cable type |
| | CR | Relay connector type |

Columnar

Square

Thin

Capacitive Type

Connector Cable

UP series

Specifications

● Inductive DC 3 wire type / 2 wire type



| Model | DC 3 wire type | | DC 2 wire type | |
|--------------------------------|---|------------|--|------------|
| | NPN | UP25F-8N□□ | Polarity | UP25F-8T□□ |
| | PNP | UP25F-8P□□ | No polarity | UP25F-8U□□ |
| Appearance |  | | | |
| Standard sensing object(mm) | Iron 25 X 25 X 1 | | | |
| Sensing distance | 8 mm | | | |
| Setting distance | 0 ~ 6.4 mm | | | |
| Hysteresis | Less than 10 % of sensing distance | | | |
| Response frequency | 200 Hz | | | |
| Power voltage | 12-24 V d.c. (Usable voltage range 5 - 35 V d.c.) | | 12-24 V d.c. (Usable voltage range 5 - 30 V d.c.) | |
| Control output | 200 mA max (Resistive load) | | 100 mA max (Resistive load) | |
| Residual voltage | Max. 1.5 V | | ● Polarity : max. 3.5 V, ● No polarity : max. 5 V | |
| Current consumption | Max. 6 mA | | - | |
| Leakage current | - | | Max. 1 mA | |
| Operation indication | Red LED | | | |
| Protection circuit | ● Power reversely connected protective circuit, ● surge protective circuit and over current protective circuit are built-in. | | ● surge protective circuit and over current protective circuit are built-in. | |
| Ambient temperature & humidity | -25 ~ 70 °C (less than ±10 % of sensing distance at temperature 20 °C), 35 ~ 85 %RH | | | |
| Insulation resistance | Min. 50 MΩ (500 V d.c. mega standard) | | | |
| Dielectric strength | 2,000 V a.c. 50/60 Hz for 1 min (between the recharging part and case) | | | |
| Vibration resistance | 10 - 55 Hz (1 min cycle, double amplitude: 1.5 mm 2 hours for each of X, Y and Z directions) | | | |
| Shock resistance | 500 m/s ² X·Y·Z 3 times to each of X, Y and Z directions | | | |
| Degree of protection | IP67 (IEC 60529) | | | |
| Connection structure | ● Cable type (standard cable length 2 m), ● Relay connector type | | | |
| Color | ● Polarity : green ● No polarity : navy | | | |
| Material | ● Case : PBT resin ● Cable holder: polyester elastomer | | | |
| Weight(g) | Cable type | 60 | 60 | |
| | Relay connector type | 20 | 20 | |

PROXIMITY SENSORS

● Inductive AC 2 wire type

| | | |
|--------------------------------|---|----|
| Model | UP25F-8A□□ | |
| Appearance |  | |
| Standard sensing object(mm) | Iron 25 X 25 X 1 | |
| Sensing distance | 8 mm | |
| Setting distance | 0 ~ 6.4 mm | |
| Hysteresis | Less than 10 % of sensing distance | |
| Response frequency | 20 Hz | |
| Power voltage | 100-240 V a.c. 50-60 Hz (usable voltage range 90-250 V a.c. 50-60 Hz) | |
| Control output | Max. 200 mA (resistive load) | |
| Residual voltage | Max. 10 V a.c. | |
| Leakage current | Max. 2.2 mA | |
| Operation indication | Red LED | |
| Protection circuit | Surge protective circuit built-in. | |
| Ambient temperature & humidity | -25 ~ 70 °C ((less than ±10 % of sensing distance at temperature 20 °C), 35 ~ 85 % RH | |
| Insulation resistance | Min. 50 MΩ (500V d.c. mega standard) | |
| Dielectric strength | 2,000 V a.c. 50/60 Hz for 1 min (between the recharging part and case) | |
| Vibration resistance | 10 - 55 Hz (1 min cycle, double amplitude : 1.5 mm 2 hours for each of X, Y and Z directions) | |
| Shock resistance | 500 m/s ² 3 times to each of X, Y and Z directions | |
| Degree of protection | IP67 (IEC 60529) | |
| Connection structure | ● Cable type (standard cable length 2 m), ● Relay connector type | |
| Color | ● NO : green, ● NC : navy | |
| Material | ● Case : PBT resin ● Cable holder : polyester elastomer | |
| Weight(g) | Cable type | 60 |
| | Relay connector type | 20 |

Suffix code (Flat type)

| Model | Code | Content |
|-----------------------|-------------|--|
| UP | □ □ □ □ □ □ | Inductive Type Proximity Sensor |
| Sensing area size | 25 | Please refer to the dimension (25.7×49.0×10.5) |
| Structure type | F | Flat Type |
| Sensing distance | 8 | 8 mm |
| Power and output type | N | DC NPN output |
| | P | DC PNP output |
| | A | AC 2 wire type |
| | T | DC 2 wire type (polarity) |
| | U | DC 2 wire type (no polarity) |
| Output state | A | Normal Open (NO) |
| | C | Normal Close (NC) |
| Connection structure | | None (Cable type) |
| | CR | Relay connector |

CUP series

Specifications

● Capacitive DC 3 wire type

| Model | NPN | CUP18R-8N□□ | CUP18RP-8N□□ | CUP30R-15N□□ | CUP30RP-15N□□ |
|--------------------------------|--|-------------|--------------|--------------------------|---------------|
| | PNP | CUP18R-8P□□ | CUP18RP-8P□□ | CUP30R-15P□□ | CUP30RP-15P□□ |
| Appearance |  | | | | |
| Shield | Non shield | | | | |
| Standard sensing object (mm) | Iron 50 X 50 X 1 (Grounded <earthed> state) | | | | |
| Sensing distance | 8 mm (Volume variation) | | | 15 mm (Volume variation) | |
| Setting distance | 0 ~ 6.4 mm | | | 0 ~ 12 mm | |
| Hysteresis | Less than 20 % of sensing distance | | | | |
| Response frequency | 50Hz | | | | |
| Power voltage | 12-24 V d.c. (Usable voltage range 10 - 30 V d.c.) | | | | |
| Control output | 200 mA max (Resistive load) | | | | |
| Residual voltage | Max. 1.5 V | | | | |
| Current consumption | Max. 10 mA | | | | |
| Operation indication | Red LED | | | | |
| Protection circuit | Power reversely connected protective circuit, surge protective circuit and over current protective circuit are built-in. | | | | |
| Ambient temperature & humidity | -25 ~ 70 °C (less than ±10 % of sensing distance at temperature 20 °C), 35 ~ 85 %RH | | | | |
| Insulation resistance | Min. 50 MΩ (500 V d.c. mega standard) | | | | |
| Dielectric strength | 2,000 V a.c. 50/60 Hz for 1 min (between the recharging part and case) | | | | |
| Vibration resistance | 10 - 55 Hz (1 min cycle, double amplitude : 1.5 mm 2 hours for each of X, Y and Z directions) | | | | |
| Shock resistance | 500 m/s ² X·Y·Z 3 times to each of X, Y and Z directions | | | | |
| Degree of protection | IP67 (IEC 60529) | | | | |
| Connection structure | ● Cable type (standard cable length 2 m), ● Relay connector type, ● Connector type | | | | |
| Color | ● NPN : green ● PNP : navy | | | | |
| Material | ● CUP-18R/CUP-30R Case : brass (chrome plated) ● Detection surface : PBT ● CUP-18RP/CUP-30RP Integrated casing and detection surface: PBT | | | | |
| Weight(g) | Cable type | 70 | 70 | 120 | 120 |
| | Relay connector type | 30 | 30 | 80 | 80 |

● Capacitive type, DC/AC dual usage 2 wire type

| Model | CUP18R-8F□□ | CUP18RP-8F□□ | CUP30R-15F□□ | CUP30RP-15F□□ |
|--------------------------------|---|--------------|--------------------------|---------------|
| Appearance |  | | | |
| Shield | Non shield | | | |
| Standard sensing object(mm) | Iron 50 X 50 X 1 (Grounded <earthed> state) | | | |
| Sensing distance | 8 mm (Volume variation) | | 15 mm (Volume variation) | |
| Setting distance | 0 ~ 6.4 mm | | 0 ~ 12 mm | |
| Hysteresis | Less than 20% of sensing distance | | | |
| Response frequency | ● DC : 40 Hz ● AC : 20 Hz | | | |
| Power voltage | 20-240 V a.c. 50-60 Hz/20-240 V d.c. (usable voltage range 18-250 V a.c. 50-50 Hz, 250 V d.c.) | | | |
| Control output | Switching capacity : 5-250 mAd.c. or less (resistive load), residual voltage : 7 V or less (AC/DC) | | | |
| Residual voltage | Max. 7 V (AC/DC) | | | |
| Leakage current | Max. 2 mA | | | |
| Operation indication | Red LED | | | |
| Protection circuit | Surge protective circuit built-in. | | | |
| Ambient temperature & humidity | -25 ~ 70 °C (less than ±10 % of sensing distance at temperature 20 °C), 35 ~ 85 %RH | | | |
| Insulation resistance | Min. 50 MΩ (500 V d.c. mega standard) | | | |
| Dielectric strength | 2,000 V a.c. 50/60 Hz for 1 min (between the recharging part and case) | | | |
| Vibration resistance | 10 - 55 Hz (1 min cycle, double amplitude : 1.5 mm 2 hours for each of X, Y and Z directions) | | | |
| Shock resistance | 500 m/s ² 3 times to each of X, Y and Z directions | | | |
| Degree of protection | IP67 (IEC 60529) | | | |
| Connection structure | ● Cable type (standard cable length 2 m), ● Relay connector type, ● Connector type | | | |
| Case | Brass (Chrome plating) | PTB resin | Brass (Chrome plating) | PTB resin |
| Color | ● NO : green ● NC : navy | NO/NC: green | ● NO: green ● NC : navy | NO/NC : green |
| Material | ● CUP-18R/CUP-30R (Case: brass chrome plating, sensing surface: PBT resin) ● CUP-18RP/CUP-30RP (Case and sensing surface one body type: PBT resin) | | | |
| Weight(g) | Cable type | 70 | 70 | 120 |
| | Relay connector type | 30 | 30 | 80 |

Columnar

Square

Thin

Capacitive Type

Connector Cable







PROXIMITY SENSORS

Suffix code (Capacitive type)

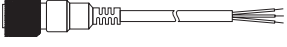
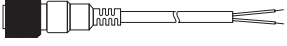
| Model | Code | Content |
|-----------------------|---|--|
| CUP - | <input type="checkbox"/> <input type="checkbox"/> <input type="checkbox"/> <input type="checkbox"/> <input type="checkbox"/> <input type="checkbox"/> | Capacitive Type Proximity Sensor |
| Sensing area size | 18 | M18 |
| | 30 | M30 |
| Structure type | R | Round type (Brass chrome plating case) |
| | RP | Round type (Plastic case) |
| Sensing distance | 8 | 8 mm (only with CUP-18□-8) |
| | 15 | 15 mm (only with CUP-30□-15) |
| Power and output type | N | DC NPN output |
| | P | DC PNP output |
| | F | AC/DC 2 wire type (dual usage) (no polarity) |
| Output state | A | Normal Open (NO) |
| | C | Normal Close (NC) |
| Connection structure | | None (Cable type) |
| | CR | Relay connector type |

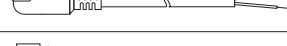
Connector Cable

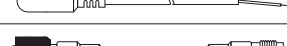
Specifications



| Classification | Appearance | Model | Cable length | Usage power |
|-----------------|---|---------|--------------|-------------|
| Connector cable |  | AA2S-2M | 2 m | AC 2 wire |
| | | AA2S-5M | 5 m | |
| |  | AD3S-2M | 2 m | DC 3 wire |
| | | AD3S-5M | 5 m | |
| |  | AD2S-2M | 2 m | DC 2 wire |
| | | AD2S-5M | 5 m | |
| |  | AA2A-2M | 2 m | AC 2 wire |
| | | AA2A-5M | 5 m | |
| |  | AD3A-2M | 2 m | DC 3 wire |
| | | AD3A-5M | 5 m | |
| |  | AD2A-2M | 2 m | DC 2 wire |
| | | AD2A-5M | 5 m | |
| Relay cable |  | BA4S-2M | 2 m | AC |
| | | BA4S-5M | 5 m | |
| |  | BD4S-2M | 2 m | DC |
| | | BD4S-5M | 5 m | |
| |  | BA4A-2M | 2 m | AC |
| | | BA4A-5M | 5 m | |
| |  | BD4A-2M | 2 m | DC |
| | | BD4A-5M | 5 m | |

Suffix code

| Model | Code | Content |
|-------------------|--|---------------------------------------|
| | <input type="checkbox"/> <input type="checkbox"/> <input type="checkbox"/> <input type="checkbox"/> <input type="checkbox"/> | Cable for Connecting proximity sensor |
| Cable | A | Connector cable |
| | B | Relay cable |
| Operating Voltage | A | AC |
| | D | DC |
| Number of wires | 2 | 2 wires |
| | 3 | 3 wires |
| | 4 | 4 wires |
| Connector type | S | Straight type |
| | A | Angle type |
| Cable length | 2M | 2 m |
| | 5M | 5 m |

PB series

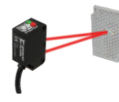
Specifications

| Model | NPN | PB-T7N | PB-T10RN | PB-T15N | PB-M3RN | PB-R01N | PB-R04RN | PB-R1N | PB-D04N |
|--------------------------------|---|------------|---|--|---|---------------------------------------|-----------------------|--------|-------------------|
| | PNP | PB-T7P | PB-T10RP | PB-T15P | PB-M3RP | PB-R01P | PB-R04RP | PB-R1P | PB-D04P |
| Appearance |  | |  | |  | | | | |
| Sensing mode | Through-beam | | | | Mirror reflection type | Diffuse - reflective | | | Distance-settable |
| Detecting object | Opaque object (over Ø12 mm) | | | | Opaque object (over Ø75 mm) | White non-glossy paper (100 x 100 mm) | | | |
| Hysteresis | None | | | | | Max. 20% of sensing distance | | | |
| Operation mode | Light ON / Dark ON mode switching selection by VR | | | | | | | | |
| Sensing distance | 7 m | 10 m | 15 m | 0.1 - 3 m (when using HY-M5) / 0.1 - 4 m (when using HY-M5S) | | 100 mm | 400 mm | 1 m | 400 mm |
| Response time | Max. 1 ms | | | | | | | | |
| Sensitivity adjustment | VR built-in | | | | | | | | |
| Power voltage | 12-24 V d.c. ±10% Ripple(p-p)10% or less | | | | | | | | |
| Current consumption | Emitter | Max. 20 mA | | | Max. 30 mA | | | | |
| | Receiver | Max. 15 mA | | | | | | | |
| Light source (wavelength) | Infrared LED (850 nm) | Red LED | Infrared LED (850 nm) | Red LED | Infrared LED (850 nm) | Red LED | Infrared LED (850 nm) | | |
| Control output | ● Load Current: max. 100mA (26.4 V d.c.) ● Residual voltage: max. 1 V | | | | | | | | |
| Protection circuit | ● Power reverse connection protection, ● Output reverse connection protection, ● Output short circuit protection, ● Putal interference protection (except transmissive), ● Output short circuit notification (except floodgators) | | | | | | | | |
| LED Indicator | ● Red LED : operation indicator, ● Green LED : stability indicator (However, the red LED of the emitter displays the power only) | | | | | | | | |
| Insulation resistance | Min. 20 MΩ (500 V d.c. mega standard) | | | | | | | | |
| Dielectric strength | 1,000 V a.c. (50/60 Hz for 1 min) | | | | | | | | |
| Vibration resistance | 10 - 55 Hz, double amplitude : 1.5 mm, X·Y·Z each direction 2 hours | | | | | | | | |
| Shock resistance | 500 m/s, X·Y·Z each direction 3 times | | | | | | | | |
| Ambient illumination | ● Sunlight : max. 11000 lx ● Incandescent lamp : max. 3000 lx | | | | | | | | |
| Ambient temperature & humidity | ● During operation : -20 ~ 60 °C ● During storage : -25 ~ 70 °C, 35 ~ 85 % RH (without condensation or icing) | | | | | | | | |
| Noise immunity | Square wave noise by noise simulator (pulse width 1 μs) ±240 V | | | | | | | | |
| Degree of protection | IP65 (IEC 60529) | | | | | | | | |
| Accessories | ● Bracket A, ● Bracket B(Order specification), ● Bracket C(Order specification) | | | | | | | | |
| Certified |  | | | | | | | | |
| Weight (g) | 90 | | | 60 | | 50 | | | |

New product Universal

Thin

Voltage output type

Columnar

Horseshoe

Built-in power Built-in amplifier

Distance setting type

Long distance Detection type

Optical fiber

Area

Sensor Controller

Suffix code

| Model | Code | | | | Content | |
|---------------------------|--------------------------|--------------------------|--------------------------|--------------------------|------------------------------|--------------------|
| PB- | <input type="checkbox"/> | <input type="checkbox"/> | <input type="checkbox"/> | <input type="checkbox"/> | General Purpose Photo Sensor | |
| Sensing mode and distance | T | 7 | | | 7 m | Through - beam |
| | | 10 | | | 10 m | |
| | | 15 | | | 15 m | |
| | M | 3 | | | 3 m | Retro - reflective |
| | | R | 01 | | | 0.1 m |
| | 04 | | | | 0.4 m | |
| | 1 | | | | 1 m | |
| D | 04 | | | 0.4 m | Distance-settable | |
| Light source | - | | | | Infrared LED | |
| | R | | | | Red LED (Note1) | |
| Output | N | | | | NPN open collector output | |
| | P | | | | PNP open collector output | |

(Note1) Red light (R): T10, M3, P3, R04, only

PHOTO SENSORS

PY series

Specifications

| Model | NPN | PY-T3N |
|--------------------------------|--|------------|
| | PNP | PY-T3P |
| Appearance |  | |
| Sensing mode | Through - beam | |
| Detecting object | Opaque object (over Ø5 mm) | |
| Operation mode | Light ON / Dark ON mode switching selection by control wire (only receiver) | |
| Sensing distance | 3 m | |
| Response time | Max. 1 ms | |
| Power voltage | 12-24 V d.c. ± 10 % | |
| Current consumption | Emitter | Max. 10 mA |
| | Receiver | Max. 15 mA |
| Light source (wavelength) | Infrared LED (850 nm) | |
| Control output | <ul style="list-style-type: none"> ● NPN or PNP open collector output, load current - max. 100 mA (26.4 V d.c. standard), ● Residual voltage - NPN: max. 1V, PNP: max. 1V | |
| Protection circuit | <ul style="list-style-type: none"> ● Power reverse protection circuit, output short circuit overcurrent protection circuit, ● Output short circuit notification circuit (Note 1), ● Output failure notification circuit (Note 2) | |
| LED Indicator | <ul style="list-style-type: none"> ● Red LED : Control output, ● Green LED : stability indicator (however, the red LED of the emitter displays the power) | |
| Insulation resistance | Min. 20 MΩ (500 V d.c. mega standard) | |
| Dielectric strength | 1,000 V a.c. (50/60 Hz for 1 min) | |
| Vibration resistance | 10 - 55 Hz, Double amplitude : 1.5 mm, X·Y·Z each direction 2 hours | |
| Shock resistance | 500 m/s ² , X·Y·Z each direction 3 times | |
| Ambient illumination | <ul style="list-style-type: none"> ● Sunlight: max. 11000 lx ● Incandescent lamp: max. 3000 lx | |
| Ambient temperature & humidity | <ul style="list-style-type: none"> ● During operation : -20 ~ 60 °C ● During storage : -25 ~ 70 °C, 35 ~ 85 % RH (without condensation) | |
| Degree of protection | IP67 (IEC 60529) | |
| Materials | <ul style="list-style-type: none"> ● Case : PC ● Lens : PC | |
| Connection | Cable extended type | |
| Weight (g) | 66 | |

(Note 1) Repeats red LED OFF for 38.4 ms after red LED turns on for 192 μs during light-on



(Note 2) Turns OFF after red LED turns ON for 49 ms during light-on

Suffix code

| Model | Code | Content |
|------------------|--|---------------------------|
| PY - | <input type="checkbox"/> <input type="checkbox"/> <input type="checkbox"/> | Flat Photo Sensor |
| Sensing mode | T | Through - beam |
| Sensing distance | 3 | 3 m |
| Output | N | NPN open collector output |
| | P | PNP open collector output |

PN series

Specifications

| Model | PN-T3 | PN-R02 | PN-M1 |
|--------------------------------|---|--|---|
| Appearance |  |  |  |
| Type | Through - beam | Diffuse - reflective | Retro - reflective |
| Sensing distance | 3 m | 200 mm | 0.1-1 m |
| Detecting object | Opaque object (over Ø8 mm) | White non-glossy paper (200 x 200 mm) | Opaque object (over Ø48 mm) |
| Power voltage | 12-24 V d.c. ±10 % | | |
| Current consumption | Emitter | 20 mA d.c. | Max. 30 mA d.c. |
| | Receiver | 18 mA d.c. | |
| Operating mode | Select Light On/Dark ON by Control Line (transmission type is only for the receiver). | | |
| Control Output | ● NPN voltage output : Load voltage max. 30 V d.c., ● Load current : max. 200 mA , residual voltage : max. 1 V | | |
| Protection circuit | Reverse polarity protection, overcurrent protection | | |
| Response time | Max. 3 ms | | |
| Hysteresis | - | Not more than 20% of detection distance | - |
| Light source (wavelength) | Infrared LED (850 nm) | | |
| Sensitivity control | By volume for sensitivity adjustment (except for transmissive floodlights) | | |
| Material | Case and Lens : PC | | |
| Connection | ● Cable withdrawal formula ● All competitors: 4P ● External diameter : 44 mm ● Length : 1.5 m (However, the projector is 3P) | | |
| Ambient light | ● Sunlight : max. 11000 lx, ● Incandescent light : max. 3000 lx | | |
| Ambient temperature & humidity | ● When operating : -25 to 55°C ● Storage : -40 to 70°C, 35 to 85% RH (but there will be no condensation). | | |
| Degree of protection | IP54 (IEC 60529) | | |
| Vibration resistance | 10 - 55 Hz, Double amplitude 1.5 mm, X·Y·Z each direction for 2 hours | | |
| Dielectric strength | 1,000 V a.c. for 1 min | | |
| Insulation resistance | 20 MΩ or more (based on 500 V d.c. mega) | | |
| Accessories | ● Bracket for fixing, ● Bolt, ● Nut for fixing | | |
| Weight (g) | 250 | 150 | 100 |

※ The sensing distance can be varied depending on the size, surface condition, glossy, non-glossy of the sensing object

※ PN-TL3 is transmitter and PN-TR3 is receiver when it is Through-beam type

Suffix code

| Model | Code | Content |
|---------------------------|---|----------------------|
| PN - | <input type="checkbox"/> <input type="checkbox"/> | Photo Sensor |
| Sensing mode and distance | T 3 | Through - beam |
| | M 1 | Retro - reflective |
| | R 02 | Diffuse - reflective |
| Operation | | 12-24 V d.c. ±10 % |

New product
Universal

Thin

Voltage output
type

Columnar

Horseshoe

Built-in
power
Built-in
amplifier

Distance
setting
type

Long
distance
Detection
type

Optical fiber





Area

Sensor
Controller

PHOTO SENSORS

PR series

Specifications

| Model | Metal | NPN | PRM-T7RN | PRM-T10N | PRM-M2N | PRM-R01N | PRM-R04N |
|-----------------------|---------|--|----------|------------|--|-----------|---|
| | | PNP | PRM-T7RP | PRM-T10P | PRM-M2P | PRM-R01P | PRM-R04P |
| | Plastic | NPN | PRP-T7RN | PRP-T10N | PRP-M2N | PRP-R01N | PRP-R04N |
| | | PNP | PRP-T7RP | PRP-T10P | PRP-M2P | PRP-R01P | PRP-R04P |
| Appearance | |  | | |  | |  |
| Detection method | | Through - beam | | | Retro - reflective | | Diffuse - reflective |
| Detection distance | | 7 m | | | 10 m | | 0.1 ~ 2 m (※Note1) |
| Hysteresis distance | | | | | | | 20% or less of detection distance |
| Detection object | | Ø 10 mm or more opaque | | | Ø 25 mm or more opaque | | White matte paper (100x100 mm) |
| Light source | | RED (640nm) | | IR (860nm) | | IR(860nm) | |
| Current consumption | | ● Emitter : 20 mA, ● Receiver : 20 mA | | | 30 mA 이하 | | |
| Power supply voltage | | 12-24 V d.c. ±10% ripple (p-p) 10% or less | | | | | |
| Control output | | NPN or PNP open collector output ● Load current : 100 mA or less (based on 26.4 V d.c.) ● Residual voltage-NPN : 1 V or less, PNP: 1 V or less | | | | | |
| Operation mode | | Light ON / Dark ON (by white line) | | | | | |
| Protection circuit | | Common ● Power reverse connection protection, ● Output reverse connection protection, ● Output short circuit overcurrent protection, ● Output terminal notification (※Note2) | | | | | |
| | | Individual - Mutual interference prevention function | | | | | |
| Response time | | 1 ms or less | | | | | |
| Insulation Resistance | | 20 MΩ or more (based on 500 V d.c. mega) | | | | | |
| Noise resistance | | Square wave noise by noise simulator (pulse width 1 μs) ±240 V | | | | | |
| Withstand voltage | | 1,000 V a.c. (50/60 Hz for 1 minute) | | | | | |
| Vibration resistance | | 10-55 Hz, dust amplitude: 1.5 mm, 2 hours each in X.Y.Z directions | | | | | |
| Shock resistance | | 500 m/s, X·Y·Z each direction 3 times | | | | | |
| Ambient illuminance | | ● Sunlight : max. 11000 lx ● Incandescent lamp : max. 3000 lx (Light-receiving surface illuminance) | | | | | |
| Ambient temperature | | ● During operation : -20 ~ 60 °C ● During storage : -25 ~ 70 °C, 35 ~ 85 % RH (without condensation or icing) | | | | | |
| Ambient Humidity | | 35 ~ 85 % RH (with no condensation) | | | | | |
| Protection structure | | IP66 (IEC standard) | | | | | |
| Acquisition standard | |  | | | | | |
| Material | | Case ● Metal: Gold plated, ● Plastic: Plastic | | | | | |
| | | Display PC | | | | | |
| | | Lens PC | | | | | |
| Accessories | | common ● Metal: 2 fixing nuts, 1 washer, V/R adjustment driver ● Plastic: 2 fixing nuts, V/R adjustment screwdriver | | | | | |
| | | Individual - Mirror (HY-M5) - | | | | | |
| Weight | | ● Metal : Approx. 320 g, ● Plastic : Approx. 280 g | | | ● Metal : Approx. 160 g, ● Plastic : Approx. 140 g | | |

(※ Note 1) Red light (R) : T7 only

(※ Note 2) Red LED blinks in case of overload (ON Time: 200 μs, OFF Time: 40 μs)





Suffix code

| Model | Code | Content | | |
|---|---------------|---------------------------|-------|----------------------|
| PR | □ - □ □ □ □ □ | Round Photo Sensor | | |
| Case material | M | Metal | | |
| | P | Plastic | | |
| Detection method and detection distance | T | 7 | 7 m | Through - beam |
| | | 10 | 10 m | |
| | R | M 2 | 2 m | Retro - reflective |
| | | 01 | 0.1 m | Diffuse - reflective |
| 04 | 0.4 m | | | |
| Light source | | Infrared LED | | |
| | R | Red LED (※Note 1) | | |
| Output | N | NPN open collector output | | |
| | P | PNP open collector output | | |

(※ Note 1) Red light (R) : T7 only

PU series

Specifications

| Model | PU-30 | PU-30S | PU-50 | PU-50S |
|--------------------------------|---|---|---|---|
| Appearance |  |  |  |  |
| Sensing distance | 30 mm | | 50 mm | |
| Detecting object | Opaque object (over Ø2 mm) | Opaque object (over Ø0.6 mm) | Opaque object (over Ø1.5 mm) | Opaque object (over Ø0.4 mm) |
| Power voltage | 12-24 V d.c. ±10 % | | | |
| Current consumption | Max. 30 mA | | | |
| Operating mode | Selectable Light On/Dark On for reverse polarity | | | |
| Control Output | <ul style="list-style-type: none"> ● NPN open collector output : Load voltage max. 300 V d.c., ● Load current : max. 180 mA, ● Residual voltage: max. 2 V | | | |
| Protection circuit | Output short circuit | | | |
| Response time | Max.1 ms | | | |
| Light source (wavelength) | Infrared LED (940 nm) | | | |
| Motion Indicator | ● Output : Red LED, ● Power : Green LED | | | |
| Sensitivity adjustment | fix | By volume | fix | By volume |
| Material | Case | Zn | | |
| | Lens | PC | | |
| Connection type | ● Cable pull-out type ● Number of wires : 3P ● Outer diameter : Ø4 mm ● Length : 2m | | | |
| Ambient light | ● Sunlight : max. 11000 lx, ● Incandescent light : max. 3000 lx | | | |
| Ambient temperature & humidity | ● In operation : -20 ~ 60 °C ● Storage : -25~70 °C, 35 ~ 85% RH (No condensation) | | | |
| Degree of protection | IP65 (IEC 60529) | | | |
| Vibration resistance | 10 - 55Hz, Double amplitude 1.5 mm, X·Y·Z each direction for 2 hours | | | |
| Dielectric strength | 1000 V a.c. for 1 min | | | |
| Insulation resistance | Min. 20 MΩ (at 500 V d.c., between code and case, contact and power supply) | | | |
| Weight (g) | 250 | | | |

| |
|-----------------------------------|
| New product Universal |
| Thin |
| Voltage output type |
| Columnar |
| Horseshoe |
| Built-in power Built-in amplifier |
| Distance setting type |
| Long distance Detection type |
| Optical fiber |
| Area |
| Sensor Controller |

PE series

Specifications





| Model | PE-T5D | PE-R05D | PE-M3D |
|--------------------------------|---|--|---|
| Appearance |  |  |  |
| Detection method | Through - beam | Diffuse - reflective | Retro - reflective |
| Sensing distance | 5 m | 0.5 m | 0.1 - 3 m |
| Detecting object | Opaque object (over 20 mm) | White non-glossy paper (200x200 mm) | Opaque object (over Ø60 mm) |
| Power voltage | 24Vd.c., 100-240 V a.c. 50/60Hz or 100-240 V d.c. ±10 % | | |
| Current consumption | Emitter | Max. 2 W | |
| | Receiver | Max. 1.6 W | |
| Operation mode | Dark ON | Light ON | Dark ON |
| Control Output | Relay output 1c 250 V a.c. 2 A (resistive load) | | |
| Response time | Max. 25 ms | | |
| Hysteresis | - | 20% or less of detection distance | - |
| Light source (wavelength) | Infrared LED (850 nm) | | |
| LED Indicator | Control output indicator : Red LED (however, the through-beam emitter red LED is a power indicator) | | |
| Sensitivity control | - | By sensitivity control volume | |
| Material | Case and lens : PC | | |
| Connection | ● Cable pull-out type, ● Number of wires : 5P, ● Outer diameter : Ø 6 mm, ● Length : 2 m (however, 2P for transmissive emitter) | | |
| Ambient light | ● Sunlight : max. 11000 lx ● Incandescent light : max. 3000 lx | | |
| Ambient temperature & humidity | ● In operation: -20 ~ 60 °C ● Storage: -25 ~ 70 °C, 35 ~ 85% RH (No condensation) | | |
| Degree of protection | IP54 (IEC 60529) | | |
| Vibration resistance | 10 - 55 Hz, double amplitude width 1.5 mm, X·Y·Z, each direction for 2 hours | | |
| Dielectric strength | 1,500V.a.c. for 1 min | | |
| Insulation resistance | 20MΩ or more (500 V d.c. Mega standard) | | |
| Accessories | ● Bracket for fixing, ● bolt, ● Nut for fixing | | |
| Weight (g) | 120 | | |

PHOTO SENSORS

PTX series

Specifications

| Model | Type | Normal | Timer Built-in | Normal | Timer Built-in | Normal | Timer Built-in |
|---|--|---|---|--|---|-------------------------------------|----------------|
| | Built-in Power Supply | PTX-T15A | PTX-T15A-T | PTX-M7A | PTX-M7A-T | PTX-R1A | PTX-R1A-T |
| | Built-in Amplifier | PTX-T15B | PTX-T15B-T | PTX-M7B | PTX-M7B-T | PTX-R1B | PTX-R1B-T |
| Appearance |  | |  | |  | | |
| Sensing Type | Through - beam | | | Retro - reflective | | Diffuse - reflective | |
| Sensing distance | 15 m | | | 7 m | | 1 m | |
| Detecting object | Opaque object (over Ø20 mm) | | | Opaque object (over Ø60 mm) | | White non-glossy paper (200x200 mm) | |
| Power voltage | Built-in Power Supply | 24-240 V a.c. 50/60Hz or 24-240 V d.c. ±10 % | | | | | |
| | Built-in Amplifier | 12-24 V d.c. ±10 % | | | | | |
| Current Consumption | Emitter | Built-in power : 2 W or less / Built-in amplifier : 35 mA or less | | Built-in power : 2 W or less / Built-in amplifier: 45 mA or less | | | |
| | Transmitter | Built-in power : 1 W or less / Built-in amplifier : 20 mA or less | | | | | |
| Control Output | Built-in Power Supply | <ul style="list-style-type: none"> ● Relay contact output (contact configuration 1a, 1b (COM)), rated load life 100,000 times or more ● Contact capacity : 30 V d.c. 5A / 250 V a.c. 5A resistive load | | | | | |
| | Built-in Amplifier | <ul style="list-style-type: none"> ● NPN/PNP open collector simultaneous output ● Load current : 150 mA d.c. Or less (resistive load) ● NPN current voltage : 1 V d.c. Below ● PNP current voltage : 2 V d.c. Below | | | | | |
| Operation mode | Light ON/Dark ON are selectable by the selector switch | | | | | | |
| Response time | Built-in Power Supply | Max. 20 ms | | | | | |
| | Built-in Amplifier | Max. 1 ms | | | | | |
| Hysteresis | Built-in Power Supply | - | | | | | |
| | Built-in Amplifier | Less than 20 % of sensing distance | | | | | |
| LED Indicator | Built-in Power Supply | ● Output indication: Red LED (Transmissive type emitter has 2 red LEDs for power indication) ● Stability indication : Green LED | | | | | |
| | Built-in Amplifier | ● Output indication : Red LED ● Stability indication : Green LED | | | | | |
| Sensitivity adjustment | - | | | Sensitivity adjusting volume built-in | | | |
| Protection circuit | Built-in Power Supply | Surge protection | | | | | |
| | Built-in Amplifier | Reverse polarity protection and output-circuit protection | | | | | |
| Timer function built-in (only corresponds to timer built-in type) | Select OFF Delay, ON Delay or One Shot Delay by using the ON/OFF switch. Delay Time: 0.1~5 sec adjust by the volume. | | | | | | |
| Ambient illumination | ● Sunlight: max. 11000 lx ● Incandescent lamp: max. 3000 lx | | | | | | |
| Ambient temperature & humidity | ● Operation temperature: -20 ~ 60 °C, ● Storage temperature: -25 ~ 70 °C, 35 ~ 85 % RH (without icing or dew condensation) | | | | | | |
| Degree of protection | IP66 (IEC 60529) | | | | | | |
| Insulation resistance | Min 20MΩ (standard on 500 V d.c. mega) | | | | | | |
| Dielectric strength | 1,500 V a.c. (for 1 min) | | | | | | |
| Vibration resistance | 10 - 55 Hz Double amplitude: 1.5 mm, 2 hours to each of X, Y, Z directions | | | | | | |
| Shock resistance | 500 m/s ² (approx. 50G), 3 times to each of X, Y, Z directions | | | | | | |
| Connection method | Terminal | | | | | | |
| Material | ● Case: ABS ● Lens: PC | | | | | | |
| Weight (g) | 80 | | | | | | |
| Accessories | Individual | - | | Reflector (HY-M5) | | - | |
| | Common | ● Driver, ● Bracket, ● bolt, ● Nut, ● Water-proof rubber, ● Wire holder | | | | | |

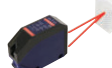
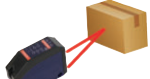
※ The sensing distance may vary depending on the size, surface condition, glossy, non-glossy of the sensing object

※ The sensing distance of PTX-M7A (-T), PTX-M7B (-T) is the distance when using the reflector HY-M5

Suffix code

| Model | Code | Content | |
|---------------------------|---|---|-----------------------|
| PTX - | <input type="checkbox"/> <input type="checkbox"/> <input type="checkbox"/> <input type="checkbox"/> | Photo Sensor | |
| Sensing mode and distance | T 15 | Through - beam | 15 m |
| | M 7 | Retro - reflective | 7 m |
| | R 1 | Diffuse - reflective | 1 m |
| Power voltage | A | 24-240 V a.c. 50/60 Hz or 24-240 V d.c. ±10 % | Built-in Power Supply |
| | B | 12-24 V d.c. ±10 % | Built-in Amplifier |
| Timer | | Normal type | |
| | -T | Timer Built-in type | |

PLD series

Specifications

| Model | PLD-R2N | PLD-R2P |
|-----------------------------------|--|---|
| Appearance |  | |
| Sensing Type | Diffuse - reflective | |
| Sensing distance | 2 m | |
| Detecting object | White non-glossy paper (200x200 mm) | |
| Power voltage | 12-24 V d.c. ±10% | |
| Power consumption | Max. 30 mA d.c. | |
| Control output | <ul style="list-style-type: none"> ● NPN open collector Max. 150 mA d.c. (resistance load) ● Residual voltage: 1 V d.c. Below | <ul style="list-style-type: none"> ● PNP open collector Max. 150 mA d.c. (resistance load) ● Residual voltage: 1 V d.c. Below |
| Operation mode | Light On mode | |
| Response time | Max. 1 ms | |
| Hysteresis | Within 20 % of detectable distance | |
| Light source (wavelength) | Infrared LED (850 nm) | |
| LED Indicator | <ul style="list-style-type: none"> ● Control output : Red LED ● Safety : green LED | |
| Sensitivity adjustment | 'Built-in' sensitivity adjustment V/R (220. degree spin V/R) | |
| Protection circuit | Reverse polarity protection, overcurrent protection | |
| Ambient intensity of illumination | <ul style="list-style-type: none"> ● Sunlight: max. 11000 Lux, ● Incandescent lamp: max. 3000 Lux | |
| Ambient temperature & humidity | <ul style="list-style-type: none"> ● When operating: -20 ~ 60 °C , ● when maintaining: -25 ~ 70 °C, max. 35 ~ 85 % RH (without freezing) | |
| Degree of protection | IP64 (IEC 60529) | |
| Insulating resistance | 20 MΩ or more (based on 500Vd.c. mega) | |
| Dielectric strength | 1000 V a.c. for 1 min | |
| Vibration resistance | 10-55 Hz double amplitude 1.5mm, X,Y,Z each direction for 2 hours | |
| Shock resistance | 500 m/s ² X·Y·Z each direction for 2 times | |
| Connection method | <ul style="list-style-type: none"> ● Cable pull-out typed ● Number of wires: 3P ● Outer diameter: Ø3 mm ● Length: 2 m | |
| Material | <ul style="list-style-type: none"> ● Case: PET ● Lens cap: PC ● Lens : PMMA | |
| Cable | 3P (26 AWG), length : 2 m | |
| Accessories | <ul style="list-style-type: none"> ● Sensitivity adjusting driver, ● Fixing volt (3-M3 X 17L) | |
| Weight (g) | 60 | |

| |
|-----------------------------------|
| New product Universal |
| Thin |
| Voltage output type |
| Columnar |
| Horseshoe |
| Built-in power Built-in amplifier |
| Distance setting type |
| Long distance Detection type |
| Optical fiber |
| Area |
| Sensor Controller |

Suffix code

| Model | Code | Content |
|------------------|--|---------------------------|
| PLD - | <input type="checkbox"/> <input type="checkbox"/> <input type="checkbox"/> | Small size photo sensors |
| Sensing mode | R | Diffuse - reflective |
| Sensing distance | 2 | 2 m |
| Output | N | NPN open collector output |
| | P | PNP open collector output |

PHOTO SENSORS

PL-D2B

Specifications



| Model | PL-D2B |
|--------------------------------|---|
| Appearance |  |
| Sensing method | Distance - settable |
| Sensing distance | 0.2 ~ 2 m |
| Detecting object | White non-glossy paper (200x200 mm) |
| Power voltage | 12-24 V d.c. ±10 % |
| Current consumption | Max. 30 mA |
| Control output | <ul style="list-style-type: none"> ● NPN / PNP open collector asynchronously, ● Load current : max. 150 mA d.c. (resistive load) ● NPN residual voltage: max. 1 V d.c., ● PNP residual voltage: max. 2 V d.c. |
| Operation mode | Light ON / Dark ON ※ Selectable by the mode V/R |
| Response time | Max. 2 ms. |
| Hysteresis | Less than 10% of the sensing distance |
| Light source (wavelength) | Infrared LED (880 nm) |
| Receiving part | 2 Photo diodes |
| LED Indicator | <ul style="list-style-type: none"> ● Control out display : Red LED ● Stability display: Green LED |
| Distance setting | Near/Far : Optical distance adjusting volume 5 cycles. |
| Protection circuit | Reverse polarity protection and output short-circuit protection |
| Ambient illumination | <ul style="list-style-type: none"> ● Sunlight: max. 11000 lx, ● Incandescent lamp: max. 3000 lx. |
| Ambient temperature & humidity | <ul style="list-style-type: none"> ● Operation: -20 ~ 60 °C ● Storage: -25 ~ 70 °C, 35 ~ 85 % RH (without condensation) |
| Degree of protection | IP65 (IEC 60529) |
| Insulation resistance | Min. 20 MΩ. (500 V d.c. Mega) |
| Dielectric strength | 1,000 V a.c. (50/60 Hz for 1 min) |
| Vibration resistance | 10 - 55 Hz, double amplitude:1.5mm for 2 hours each in X. Y and Z directions. |
| Shock resistance | 500 m/s ² 3 times each in X. Y and Z directions. |
| Connection method | <ul style="list-style-type: none"> ● Cable output type, ● Number of wires: 4P, ● Thickness: Ø 4mm ● Length 2m |
| Material | <ul style="list-style-type: none"> ● Case : PC, ● Lens : PC |
| Accessory | Bracket, Adjustable driver, bolt, Nut. |

Suffix code

| Model | Code | Content |
|------------------|--|--------------------------------|
| PL - | <input type="checkbox"/> <input type="checkbox"/> <input type="checkbox"/> | Distance-Settable Photo Sensor |
| Sensing mode | D | Distance-settable |
| Sensing distance | 2 | 2 m |
| Power voltage | B | 12-24 V d.c. |

PEN series

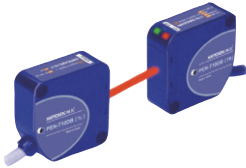
Specifications

| Model | | Built-in power | | |
|---------------------------|-------------|---|--|---|
| | | PEN-T10A | PEN-M5A | PEN-R700A |
| Appearance | |  |  |  |
| Sensing Type | | Through - beam | Retro - reflective | Diffuse - reflective |
| Sensing distance | | 10 m | 0.1 ~ 5 m | 700 mm |
| Detecting object | | Opaque object (over Ø20 mm) | Opaque object (over Ø60 mm) | White non-glossy paper (200x200 mm) |
| Power voltage | | 24-240 V a.c. 50/60Hz or 24-240 V d.c. ±10 % | | |
| Current Consumption | Emitter | Max. 1 W | Max. 2 W | |
| | Transmitter | Max. 2 W | | |
| Operation mode | | Light-incident operation (Light ON) / Light-shielding operation (Dark ON) ※ Selection by mode volume | | |
| Sensitivity adjustment | | - | Built-in sensitivity adjustment volume | |
| Control Output | | ● Relay output (Contact composition 1a, 1b), ● Capacity : 30 V d.c. 5 A / 250 V a.c. 5 A resistance load life expectancy - min. 100 thousand times | | |
| Response time | | Less than 20 ms | | |
| Hysteresis | | - | Within 20 % of detecting distance | |
| Light source (wavelength) | | Infrared LED (850 nm) | | |
| Indicator light | | ● Control out display : Red LED ● Stability display : Green LED (However, the red LED of the transmissive emitter is a power indicator.) | | |
| Ambient light | | ● Sunlight : less than 11000 lx, ● Incandescent lamp : less than 3000 lx | | |
| Ambient temperature | | ● Operation : -20 ~ 60 °C ● Storage : -25 ~ 70 °C, 35 ~ 85 % RH (without condensation) | | |
| Degree of protection | | IP 64 (IEC) | | |
| Insulation resistance | | Min. 20 MΩ. (500 V d.c. Mega) | | |
| Dielectric strength | | 1,500 V a.c. (50/60 Hz for 1 min) | | |
| Vibration resistance | | 10 - 55 Hz double amplitude:1.5mm for 2 hours each in X, Y and Z directions. | | |
| Shock resistance | | 500 m/s ² 500m/s ² (about 50G), 3 times each in X, Y, Z directions | | |
| Connection method | | ● Cable output type, ● Number of wires : 5P, ● Thickness : Ø 6mm ● Length 2m (However, the emitter is 2P) | | |
| Material | | ● Case : heat-resistant ABS ● Lens : P.C | | |
| Weight (g) | | 150 | | |

| |
|-----------------------------------|
| New product Universal |
| Thin |
| Voltage output type |
| Columnar |
| Horseshoe |
| Built-in power Built-in amplifier |
| Distance setting type |
| Long distance Detection type |
| Optical fiber |
| Area |
| Sensor Controller |



Suffix code

| Model | Code | Content | |
|---------------------------|-------|---|-----------|
| PEN - | □ □ □ | Photo Sensor | |
| Sensing mode and distance | T 10 | Through - beam | 10 m |
| | M 5 | Retro - reflective | 0.1 - 5 m |
| | R 700 | Diffuse - reflective | 700 mm |
| Power voltage | A | 24-240 V a.c. 50/60 Hz or 24-240 V d.c. ±10 % | |

PHOTO SENSORS

PG series

Specifications

| Model | NPN | PG-TRN | PG-TARN |
|--------------------------------|---|---|---|
| | PNP | PG-TRP | PG-TARP |
| Appearance |  | |  |
| Function | Selection by switch (Normal/ON-Delay/OFF-Delay) 40 ms fixed | | Selection by switch (Normal/ON-Delay/Off-Delay/One-Shot) 1 ms-5,000 ms variable |
| Sensing method | Through-beam type, diffuse-reflective type (decision by combined with fiber unit) | | |
| Sensing distance | Decision by combined with fiber unit | | |
| Power voltage | 12-24 V d.c. ±10 % | | |
| Current consumption | Max. 35 mA | | |
| Output | Control | ● NPN/PNP Voltage output ● Load voltage: max. 200 mA (30 V d.c.) ● Residual voltage : max. 1 V d.c. | |
| | Stability | - | ● NPN/PNP Voltage output ● Load current : 50 mA (30 V d.c.) or less, ● Residual voltage : max. 1 V d.c. |
| Operation mode | Light ON / Dark ON switch selection operating Normal or ON/OFF delay Switch selection operating | | |
| Response time | Max. 1 ms | | |
| Hysteresis | Max. 10 % of sensing distance (Reflection) | | |
| Light source (wavelength) | Red LED (630 nm) | | |
| LED Indicator | ● Control out display : Red LED ● Stability display : Green LED | | |
| Sensitivity adjustment | Sensitivity adjustment by brewing well volume (Coarse) and fine adjustment volume (Fine) | | |
| Protection circuit | Reverse polarity protection, overcurrent protection (except for stable output of multi-function type) | | |
| Ambient illumination | ● Sunlight : max. 11000 lx, ● Incandescent lamp : max. 3000 lx | | |
| Ambient temperature & humidity | ● Operating : -20 ~ 60 °C, ● Preserving : -25 ~ 70 °C, 35 ~ 85 % RH (without condensation) | | |
| Degree of protection | IP40 (IEC 60529) | | |
| Insulating resistance | Min. 20 MΩ (500 V d.c. Mega standard) | | |
| Dielectric strength | 1,000 V a.c. (50/60 Hz for 1 min) | | |
| Vibration resistance | 10 - 55 Hz double amplitude 1.5mm, X,Y,Z each direction for 2 hours | | |
| Shock resistance | 500m/s² X, Y, Z directions 3 times | | |
| Connection method | Cable pull-out type (3 P, 2 m) | | Cable pull-out type (4 P, 2 m) |
| Weight (g) | 120 | | |

Suffix code

| Model | Code | Content |
|---------------------------|---|---|
| PG - | <input type="checkbox"/> <input type="checkbox"/> | Fiber Optic Sensor |
| Sensing mode and distance | TR | Universal type |
| | TAR | Multifunctional (Built-in timer function and stable output) |
| Output | N | NPN open collector output |
| | P | PNP open collector output |

PFD series

Specifications

| Model | NPN | PFD-RGN | PFD-RMN |
|--------------------------------|----------------|---|--|
| | PNP | PFD-RGP | PFD-RMP |
| Appearance | |  | |
| Function | Mark detection | General type (mark detection) | Multi type (mark detection, rotation speed, counter) |
| | Counter | - | 400 cps, Up/Down, 0 - 9999 |
| | Tachometer | - | 12 ~ 9999 rpm |
| Power supply voltage | | 12-24 V d.c. ±10 % | |
| Current consumption | | Max. 50 mA | |
| Output | Control | ● NPN/PNP Open collector output, ● Load current: 100 mA (30 V d.c.) or less ● Residual voltage: 1V d.c. or less | |
| | Stability | | |
| External input | | Teaching | Teaching / Reset input |
| Operating mode | | Selecting Light On / Dark On (selection by parameter) | |
| Timer function | | ON-Delay, OFF-Delay, One-shot time output (Setting time: 1 ~ 9999 ms) | |
| On/Off Delay | | 0 ~ 9999 ms | |
| Light source (wavelength) | | Red LED (660 nm) | |
| Protection circuit | | Power reverse connection and output short protection circuit | |
| Response time | | 0.7 ms or less | 1 ms or less |
| LED indicator | | 4 Digits FND | |
| Sensitivity control | | Auto teaching/manual setting by setting button | |
| Additional function | | ● Brightness control 180° Turning indication, ● Display time set, ● Zero Reset, ● Initial reset, Lock function | |
| Ambient light | | ● Sunlight : max. 11000 lx, ● Incandescent lamp : max. 3000 lx | |
| Ambient temperature & humidity | | ● Operating : -20 ~ 60 °C, ● Preserving : -25 ~ 70 °C, 35 ~ 85 % RH (without condensation) | |
| Vibration resistance | | 10 - 55 Hz double amplitude 1.5mm, X,Y,Z each direction for 2 hours | |
| Shock resistance | | 500m/s² X, Y, Z directions 3 times | |
| Dielectric strength | | 1,000 V a.c. (50/60 Hz for 1 min) | |
| Insulating resistance | | Min. 20 MΩ (500 V d.c. Mega standard) | |
| Connection method | | ● Cable output type, ● Number of wires: 5P, ● Thickness : Ø 4mm, ● Length 2m, ● DIN rail mounting structure | |
| Weight (g) | | 150 | |

● MODEL : PFD-RMN only

| | | |
|----------------|------------|--|
| Multi function | Counter | ● UP / DOWN Mode, ● Prescale 1 ~ 999 distribution/dispensing setting, ● Indicating range: 0 ~ 9999, ● Counting speed : 400 cps (50 % duty), ● Output mode: 8 kinds selectable (N, F, C, R, K, P, Q, A), ● External reset: Min. Signal width 5 ms |
| | Tachometer | ● Indicating range: 0 ~ 9999 rpm, ● Speed monitoring output function, ● Prescale: 1~1000 integers setting, ● Measurement cycle setting |

Suffix code

| Model | Code | Content |
|-----------------|--|-----------------------------------|
| PFD - | <input type="checkbox"/> <input type="checkbox"/> <input type="checkbox"/> | Digital optical fiber sensor |
| Light source | R | Red LED |
| Function | G | General purpose (MARK) |
| | M | Multi type (MARK / RPM / Counter) |
| External output | N | NPN open collector |
| | P | PNP open collector |

| |
|-----------------------------------|
| New product Universal |
| Thin |
| Voltage output type |
| Columnar |
| Horseshoe |
| Built-in power Built-in amplifier |
| Distance setting type |
| Long distance Detection type |
| Optical fiber |
| Area |
| Sensor Controller |

PHOTO SENSORS

PFB series

Specifications



| Model | NPN | PFB-RN |
|---------------------------|--|--------|
| | PNP | PFB-RP |
| Appearance |  | |
| Detection method | Transmissive type, reflective type (by fiber cable) | |
| Detection distance | By fiber cable | |
| Power voltage | 12-24 V d.c. ±10 % (Ripple 10 %이하) | |
| Current consumption | Max. 20 mA | |
| Control output | ● NPN/PNP Open collector output, ● Load current: 100 mA (30 V d.c.) or less ● Residual voltage: 1 V d.c. or less | |
| Output operation | Selection by light-incident (Light On) and light-shielding (Dark On) switches | |
| Timer function | NORMAL, ON-Delay, OFF-Delay (Delay time 40 ms fixed) | |
| Response time | 1 ms or less | |
| Hysteresis | Reflective type: 10% or less of the sensing distance | |
| Light source (wavelength) | Red LED (660 nm) | |
| Indicator light | Indication by Bar LED | |
| Sensitivity control | Auto teaching / manual setting by setting button | |
| Protection circuit | Mutual interference prevention, power reverse connection and output short protection circuit | |
| Ambient light | ● Sunlight : max. 11000 lx, ● Incandescent lamp : max. 3000 lx | |
| Ambient temperature | -10 ~ 55 °C (Storage ambient temperature: -25 ~ 70 °C) | |
| Ambient Humidity | 35 ~ 85% R.H. (No condensation or freezing) | |
| Degree of protection | IP 40 (IEC) | |
| Insulation resistance | More than 20 MΩ (at 500 V d.c. between code and case, adjusting switch and case) | |
| Dielectric strength | 1000 V a.c., 50/60 Hz for 1 min | |
| Vibration resistance | 10 - 55 Hz double amplitude width 1.5 mm, X·Y·Z, each direction for 2 hours | |
| Insulation resistance | 500 mΩ X, Y, Z each direction 3 times | |
| Connection method | ● Cable output type, ● Number of wires: 5 P, ● Thickness : Ø 4 mm, ● Length 2 m, ● DIN rail mounting structure | |
| Material | Case: Heatproof ABS | |
| Weight (g) | Approx. 150 g (fixing bracket and packaging) | |

Suffix code

| Model | Code | Content |
|-----------------|---|--|
| PFB - | <input type="checkbox"/> <input type="checkbox"/> | 10 bit A / D Built-in bar display type |
| Light source | R | Red LED |
| External output | N | NPN open collector |
| | P | PNP open collector |

PAS series

Specifications

| Model | NPN | PAS-T4NL | PAS-T8NL | PAS-T12NL | PAS-T16NL | PAS-T20NL |
|------------------------|--|------------|------------|-------------|-------------|-------------|
| | PNP | PAS-T4ND | PAS-T8ND | PAS-T12ND | PAS-T16ND | PAS-T20ND |
| | | PAS-T4PL | PAS-T8PL | PAS-T12PL | PAS-T16PL | PAS-T20PL |
| | | PAS-T4PD | PAS-T8PD | PAS-T12PD | PAS-T16PD | PAS-T20PD |
| Appearance |  | | | | | |
| Number of optical axis | | 4 | 8 | 12 | 16 | 20 |
| Sensing range | | 60 mm | 140 mm | 220 mm | 300 mm | 380 mm |
| Detection distance | 5 m | | | | | |
| Detection object | Opaque material of Ø 30 mm or more | | | | | |
| Optical axis pitch | 20 mm | | | | | |
| Light source | IR (860 nm) | | | | | |
| Power voltage | 12-24 V d.c. ±10% ripple (p-p) 10% or less | | | | | |
| Current Consumption | | Max. 80 mA | Max. 90 mA | Max. 100 mA | Max. 110 mA | Max. 120 mA |
| Control output | NPN / PNP open collector output-Load current : max. 100 mA, ● Load current : 100 mA (30 V d.c.) or less ● Residual voltage : 1 V d.c. Below | | | | | |
| Operating mode | Light ON or Dark ON | | | | | |
| LED Indicator | ● Emitter : Power indicator (green LED), M/S indicator (red LED) ● Receiver : Incoming light stability indicator (green LED), output indicator (red LED), E1 indicator (red LED), E2 indicator (blue LED) | | | | | |
| Protection circuit | ● Power reverse connection protection, ● Output short circuit overcurrent protection, ● Mutual interference prevention function | | | | | |
| Response time | 7 ms or less | | | | | |
| Insulation Resistance | 20 MΩ or more (based on 500 VDC mega) | | | | | |
| Noise resistance | Square wave noise by noise simulator (pulse width 1μs) ± 240 V | | | | | |
| Dielectric strength | 1,000 V a.c. (50/60 Hz for 1 min) | | | | | |
| Vibration resistance | 10 - 55 Hz double amplitude width 1.5 mm , X·Y·Z, each direction for 2 hours | | | | | |
| Shock resistance | 500 m/s², X·Y·Z each direction 3 times | | | | | |
| Ambient light | ● Sunlight : max. 11000 lx, ● Incandescent lamp : max. 3000 lx | | | | | |
| Ambient temperature | ● Operating : -10 ~ +55 °C, ● Preserving : -25 ~ +70 °C (However, no freezing or condensation) | | | | | |
| Ambient humidity | 35 ~ 85 % RH (However, no condensation) | | | | | |
| Degree of protection | IP40 (IEC standard) | | | | | |
| Acquisition standard |  | | | | | |
| Connection method | When taking out the cable (Number of wires : 5 P, Length : 3 m, Outer diameter : Ø 4 mm) | | | | | |
| Material | Case | ABS | | | | |
| | Display | Acryl | | | | |
| | Lens | Acryl | | | | |
| Weight (g) | | 160 | 180 | 200 | 220 | 240 |

Suffix code

| Model | Code | Content |
|------------------------|--|-----------------------|
| PAS - | <input type="checkbox"/> <input type="checkbox"/> <input type="checkbox"/> <input type="checkbox"/> <input type="checkbox"/> | Area Sensor slim type |
| Optical axis spacing | 20 | 20 mm |
| Sensing mode | T | Through - beam |
| Number of optical axis | 4 | 4 optical axis |
| | 8 | 8 optical axis |
| | 12 | 12 optical axis |
| | 16 | 16 optical axis |
| | 20 | 20 optical axis |
| Control output | N | NPN open collector |
| | P | PNP open collector |
| Operation mode | L | Light ON |
| | D | Dark ON |

| |
|-----------------------------------|
| New product Universal |
| Thin |
| Voltage output type |
| Columnar |
| Horseshoe |
| Built-in power Built-in amplifier |
| Distance setting type |
| Long distance Detection type |
| Optical fiber |
| Area |
| Sensor Controller |

AREA SENSORS

PAN series CE

Specifications

| Model | NPN | PAN20-T□□ | PAN40-T□□ |
|-----------------------|--|-----------|-----------------------------|
| | PNP | PAN20-T□P | PAN40-T□P |
| Appearance |  | | |
| Sensing type | Through - beam | | |
| Sensing distance | 7 m | | |
| Detecting object | Opaque object (over Ø32 mm) | | Opaque object (over Ø52 mm) |
| Optical axis pitch | 20 mm | | 40 mm |
| Power voltage | 12-24 V d.c. ±10% ripple (p-p) 10% or less | | |
| Current Consumption | Max. 170 mA | | Max. 100 mA |
| Control output | NPN or PNP open collector output, ● Load current : 100 mA (26.4 VDC standard) or less ● Residual voltage : 1 V d.c. Below | | |
| Operation mode | ● Emitter : M/S mode switch switching type (Master / Slave) ● Receiver : D/L mode switch switching type (Dark ON, Light ON) | | |
| Operation indicator | ● Emitter : Power indicator (green LED), M/S indicator (red LED) ● Receiver : Incoming light stability indicator (green LED), output indicator (red LED), E1 indicator (red LED), E2 indicator (blue LED) | | |
| Protection circuit | ● Power reverse connection protection, ● Output short circuit overcurrent protection, ● Mutual interference prevention function | | |
| Response time | Max. 15 ms | | |
| Insulation Resistance | 20 MΩ or more (based on 500 VDC mega) | | |
| Noise resistance | Square wave noise by noise simulator (pulse width 1μs) ± 240 V | | |
| Dielectric strength | 1,000 V a.c. (50/60 Hz for 1 min) | | |
| Vibration resistance | 10 - 55 Hz double amplitude width 1.5 mm , X·Y·Z, each direction for 2 hours | | |
| Shock resistance | 500 m/s, X·Y·Z each direction 3 times | | |
| Ambient light | ● Sunlight : max. 11000 lx, ● Incandescent lamp : max. 3000 lx(receiving surface illuminance) | | |
| Ambient temperature | ● Operating : -10 ~ +55 °C, ● Preserving : -25 ~ +70 °C (However, no freezing or condensation) | | |
| Ambient humidity | 35 ~ 85 % RH (However, no condensation) | | |
| Degree of protection | IP65 (IEC standard) | | |
| Acquisition standard | CE | | |
| Connection method | When taking out the cable (Number of wires : 4 P, Length : 200 mm, Outer diameter : Ø 5.5 mm) | | |
| Material | Case | Aluminum | |
| | Front cover | Acryl | |
| | Lens | Acryl | |

Suffix code

| Model | Code | Content |
|------------------------|----------|--|
| PAN | □ -□ □ □ | Area Sensor |
| Optical axis pitch | 20 | 20 mm spacing |
| | 40 | 40 mm spacing |
| Sensing method | T | Through - beam |
| Number of optical axis | | Number of optical axis (please refer to the dimension) |
| Output | N | NPN open collector |
| | P | PNP open collector |

Suffix code

| | |
|--------|---|
| PAN 20 | 8, 12, 16, 20, 24, 28, 32, 36, 40, 44, 48 |
| PAN 40 | 4, 6, 8, 10, 12, 14, 16, 18, 20, 22, 24 |

HPAN series

Specifications

| Model | HPAN-C7 | HPAN-CT7 | HPAN-C7W |
|--------------------------------|---|---|-------------------------|
| Appearance |  | | |
| WXHxD(mm) | 38.5×82.1×80.8 | | |
| Function | Universal | High function | Two sensors connectable |
| How to attach | DIN Rail | | |
| Power Voltage | 110 - 220 V a.c., 50/60 Hz, ±10 % | | |
| Power consumption | Approx. 5 VA | | |
| Power supply to sensor | 12 V d.c. (±10 %), Load current: 200 mA or less | | |
| Input | <ul style="list-style-type: none"> ● [L] Level 0-2 V d.c., Internal pull-up/pull-down resistance connection by NPN/PNP switch setting (4.7 kΩ), ● [H] Level 4-30 V d.c., ● NORM/INV input signal inversion function | | |
| Output | Contact point | <ul style="list-style-type: none"> ● NO contact : 250 V a.c. 3 A resistance load ● NC contact : 250 V a.c. 2 A resistance load ● Relay rated load life : 100,000 times | |
| | Contactless | <ul style="list-style-type: none"> ● NPN open collector output, load current : 100 mA (30 V d.c.) or less ● Residual voltage : 1VDC or less, ISOLATION (insulation from internal circuit) | - |
| Response time | <ul style="list-style-type: none"> ● Relay contact : approx. 10 ms, ● NPN open collector : max. 5 μs | | |
| External synchronization | IN, ES period synchronization output function | IN, ES period synchronization and differential synchronization output function | - |
| Timer function | - | <ul style="list-style-type: none"> ● 3 types of timer setting modes (ON DELAY, OFF DELAY, ONE SHOT DELAY) ● Timer time can be set (selected by dip switch) 40 ms~1 sec ↔ 0.4 s~10 sec | - |
| Ambient temperature & humidity | <ul style="list-style-type: none"> ● Operating : -20 ~ 60 °C, ● Preserving : -25 ~ 70 °C, 35 ~ 85 % RH (without condensation) | | |
| Noise immunity | Power line : 2000 VP, 0.5 μs pulse width (by noise simulation) | | |
| Dielectric strength | 1,500 V a.c. 1 minute at 60 Hz | | |
| Insulation resistance | 20 MΩ (based on 500Vd.c. mega) | | |
| Vibration resistance | 10-55 Hz (cycle 1 minute), double amplitude: 1.5 mm, 2 hours in each of X, Y, and Z directions (however, power is not turned on) | | |
| Shock resistance | 100m ^g X, Y, Z directions twice each (however, the power is not turned on) | | |
| Weight (g) | 160 | | |

| |
|-----------------------------------|
| New product Universal |
| Thin |
| Voltage output type |
| Columnar |
| Horseshoe |
| Built-in power Built-in amplifier |
| Distance setting type |
| Long distance Detection type |
| Optical fiber |
| Area |
| Sensor Controller |

HPA-12



Specifications

| Model | HPA-12 |
|--------------------------------|--|
| Appearance |  |
| WXHxD(mm) | 49.0×61.0×90.0 |
| Function | Multi-purpose |
| How to attach | Relay Socket 8PIN |
| Power Voltage | 220 V a.c. ±10 % 60 Hz |
| Power consumption | Approx. 4 VA |
| External output power | 12 V d.c. ±10%, Load current: 50 mA or less |
| Connectable sensor (Input) | NPN, PNP Transistor output sensor |
| Output | Relay contact : 1 c (250 V a.c. 3 A, resistive load, rated load life: 100,000 times) |
| Response time | Approx. 10 ms |
| Ambient temperature & humidity | <ul style="list-style-type: none"> ● Operating : -20 ~ 60 °C, ● Preserving : -25 ~ 70 °C, 35 ~ 85 % RH (without condensation) |
| Noise immunity | <ul style="list-style-type: none"> ● Power line : 1,500 Vp ● Pulse width : 0.5 μs (noise simulator) |
| Dielectric strength | 1500 V a.c. for 1 min (between supply and output) |
| Insulation resistance | 20 MΩ (based on 500Vd.c. mega) |
| Vibration resistance | 10 - 55 Hz (for a minute), double amplitude width 1.5 mm, each X·Y·Z direction for 2 hour (in power off) |
| Shock resistance | 100 m ^g (Approx. 10 G), each X·Y·Z, 2 direction (in power off) |
| Weight (g) | 260 |

ROTARY ENCODERS

HE30B, HE40B, HE50B series

Specifications

| Model | | HE30B | HE40B | HE50B | |
|---------------------------|--------------------------------|--|--|---|--|
| Appearance | |  |  |  | |
| Electrical specifications | Output phase difference | Phase difference between the phase A and B : T/4 ± T/8 (1 cycle of A phase=T) | | | |
| | Response speed | Max. 200 kHz | | | |
| | Rated voltage | NPN voltage output | ※ Depending on the model name composition | | |
| | | Open collector | 5-12 V d.c. ±5 % | | |
| | | Totem pole output | 12-24 V d.c. ±5 % | | |
| | | Line driver output | 5 V d.c. ±5 % | 5 V d.c. / 12 V d.c. / 24 V d.c. ±5 % | |
| | Current consumption | Max. 60 mA (no load) | | | |
| | Connection method | Cable extended type | | | |
| | Control output | NPN voltage output | ● Load current : max. 30 mA ● Load current : 30 mA or less, ● Residual voltage : 0.4 V or less | | |
| | | NPN open collector | | | |
| Totem pole output | | LOW (load current : max. 30 mA, residual voltage : max. 0.4 V d.c.) HIGH (load current : max. 10 mA, output voltage : above rated voltage -2.5 V) | | | |
| Line driver output | | LOW (load current : max. 20 mA, residual voltage: max. 0.4 V) HIGH (load current : max. 20 mA, residual voltage: min. 2.5 V) | | | |
| Response time | Voltage output | Max. 1 μs (wire length : 1.5 m, sinking current= max. 30 mA) | | | |
| | Open collector | | | | |
| | Totem pole output | Max. 1 μs (wire length : 1.5 m, sinking current= max. 10 mA) | | | |
| | Line driver output | Max. 1 μs (wire length : 1.5 m, sinking current= max. 30 mA) | | | |
| Mechanical specifications | Starting torque | 2×10 ⁻³ N·m | 4×10 ⁻³ N·m | 7×10 ⁻³ N·m | |
| | Moment of inertia | Max 2 × 10 ⁻⁶ kg·m ² | Max 4 × 10 ⁻⁶ kg·m ² | Max 8 × 10 ⁻⁶ kg·m ² | |
| | Permissible shaft loading | ● Radial : within 15 N ● Thrust : within 10 N | ● Radial : within 30 N ● Thrust : within 20 N | ● Radial : within 50 N ● Thrust : within 30 N | |
| | Max. number of revolutions | 5,000 r/min | | | |
| Ambient specifications | Insulation resistance | Min. 100 MΩ (between the terminal and case 500 V d.c. mega standard) | | | |
| | Dielectric strength | 800 V a.c. 60 Hz for 1 min (between the terminal and case) | | | |
| | Vibration resistance | 10 - 55 Hz (cycle for 1 min), double amplitude : 1.5 mm, for 2 hours each in X, Y and Z directions | | | |
| | Shock resistance | Max. 490 m/s ² | | Max. 735 m/s ² | |
| | Ambient temperature & humidity | -10 ~ 70 °C, 35 ~ 85 % RH (without condensation), during storage: -25 ~ 85 °C | | | |
| | Cable | ● 5P, Ø5.0 mm, length : 1.5 m, shield cable (HE40B, HE50B specifications : 2m, 8m, 10 m) ● Line driver type : 8P, Ø5.0 mm, length : 1.5 m, shield cable | | | |
| | Accessories | Ø 4.0 mm coupling | Ø 6.0 mm / Ø 8.0 mm coupling | Ø 8.0 mm coupling, bracket | |
| Weight (g) | 120 | 170 | 200 | | |

Suffix code

| Model | Code | Content | |
|------------------|----------------|--|---|
| HE | □- □ □ □ □ □ □ | Shaft Rotary Encoder (incremental) | |
| Dimension | 30B 4 | Outer diameter : Ø 30 mm axis : Ø 4 mm | |
| | 40B 6 | Outer diameter : Ø 40 mm axis : Ø 6 mm | |
| | 8 | Outer diameter : Ø 40 mm axis : Ø 8 mm Option : (Option) | |
| | 50B 8 | Outer diameter : Ø 50 mm axis : Ø 8 mm | |
| Number of pulses | * | Refer to "Number of pulses (resolution)" | |
| Output signal | 2 | A, B phase output | |
| | 3 | A, B, Z phase output | |
| | 3C | A, B, Z̄ phase output | |
| | 4 | A, Ā, B, B̄ phase output | |
| | 6 | A, Ā, B, B̄, Z, Z̄ phase output | |
| Output circuit | N | 12 | NPN voltage output (5 - 12 V d.c.) |
| | | 24 | NPN voltage output (12-24 V d.c.) |
| | O | 12 | NPN open collector output (5 - 12 V d.c.) |
| | | 24 | NPN open collector output (12-24 V d.c.) |
| | T | 12 | Totem pole output (5 - 12 V d.c.) |
| | | 24 | Totem pole output (12-24 V d.c.) |
| | L | 5 | Line driver Output (5 V d.c.) |
| | | 12 | Line driver Output (12 V d.c.) |
| 24 | | Line driver Output (24 V d.c.) | |

(Note) *J is output only for A, B phase (line driver output: A, Ā, B, B̄ phase).
Pulses other than the ones in the chart are order-made

Number of pulses (resolution)

| Model | Number of pulses per revolution |
|---------------|---|
| HE30B | 100, 200, 360, 500, 1000, 1024 |
| HE40B / HE50B | *1, *2, *5, 10, *12, 15, 20, 25, 30, 40, 45, 50, 60, 75, 100, 120, 125, 150, 192, 200, 240, 250, 256, 300, 360, 400, 500, 512, 600, 800, 1000, 1024 |

※ Please contact us if you have any request for pulse production

HE40H series

Specifications

| Model | | HE40H | |
|---------------------------|--------------------------------|--|---|
| Appearance | |  | |
| Electrical specifications | Output phase difference | Phase difference between the phase A and B : $T/4 \pm T/8$ (1 cycle of A phase=T) | |
| | Response speed | 200 KHz max. | |
| | Rated voltage | NPN voltage output | ※ Depending on the model name composition |
| | | Open collector | 5-12 V d.c. $\pm 5\%$ |
| | | Totem pole output | 12-24 V d.c. $\pm 5\%$ |
| | | Line driver output | 5 V d.c. $\pm 5\%$ |
| | Current consumption | Max. 60 mA (no load), line driver output max. 50 mA (no load) | |
| | Connection method | Cable extended type | |
| | Control output | NPN voltage output | ● Load voltage : max. 30 V, ● Load current : max. 30 mA, ● Residual voltage : max. 0.4 V |
| | | NPN open collector | |
| | | Totem pole output | LOW (load current: max. 30 mA, residual voltage: max. 0.4 V) HIGH (load current : max. 10 mA, output voltage: above rated voltage - 2.5 V) |
| | | Line driver output | LOW (load current: max. 20 mA, max. 0.4 V) HIGH (load current : max. 20 mA, residual voltage: min. 2.5V) |
| | Response time | Voltage output | Max. 1 μ s (wire length: 1.5 m, sinking current= 30 mA) |
| | | Open collector | |
| Totem pole output | | Max. 1 μ s (wire length: 1.5 m, sinking current= max. 10 mA.) | |
| Line driver output | | Max. 1 μ s (wire length: 1.5 m, sinking current= max. 30 mA) | |
| Mechanical specifications | Starting torque | 4×10^{-3} N.m | |
| | Moment of inertia | 4×10^{-6} g·cm ² max | |
| | Permissible shaft loading | ● Radial : within 30 N ● Thrust : within 20 N | |
| | Max. number of revolutions | 5,000 r/min | |
| Ambient specifications | Insulation resistance | Min. 100 M Ω (between the terminal and case 500 V d.c. mega standard) | |
| | Dielectric strength | 800 V a.c. 60 Hz for 1 min (between the terminal and case) | |
| | Vibration resistance | 10 - 55 Hz (cycle for 1 min), double amplitude : 1.5 mm, for 2 hours each in X, Y and Z directions | |
| | Shock resistance | 490 m/s ² max | |
| | Ambient temperature & humidity | -10 ~ 70 °C (without icing), during storage: -25 ~ 85 °C, 35 ~ 85 % RH | |
| | Cable | ● 5 P, $\varnothing 5.0$ mm, length : 1.5 m, shield cable (HE40H cable length option : 2 m, 8 m, 10 m) ● Line drive type : 8P, $\varnothing 5.0$ mm, length : 1.5 m, shield cable | |
| | Weight (g) | 170 | |

Axial

Hollow shaft type

Clogged hollow Axial

Wheel type

Suffix code

| Model | Code | Content |
|------------------------------|--|---|
| HE | <input type="checkbox"/> - <input type="checkbox"/> <input type="checkbox"/> <input type="checkbox"/> <input type="checkbox"/> <input type="checkbox"/> <input type="checkbox"/> | Hollow Shaft Rotary Encoder (incremental) |
| Dimension | 40H | 6 Outer diameter : $\varnothing 40$ mm axis inner diameter : $\varnothing 6$ mm |
| | 8 | Outer diameter : $\varnothing 40$ mm axis inner diameter : $\varnothing 8$ mm |
| | 10 | Outer diameter : $\varnothing 40$ mm axis inner diameter : $\varnothing 10$ mm |
| | 12 | Outer diameter : $\varnothing 40$ mm axis inner diameter : $\varnothing 12$ mm |
| Number of pulse | * | Refer to the pulse code chart (resolving power) |
| Output signal (output phase) | 2 | A, B phase output |
| | 3 | A, B, Z phase output |
| | 3C | A, B, \bar{Z} phase output |
| | 4 | A, \bar{A} , B, \bar{B} phase output |
| | 6 | A, \bar{A} , B, \bar{B} , Z, \bar{Z} phase output |
| Output circuit | N | 12 NPN voltage output (5 - 12 V d.c.) |
| | | 24 NPN voltage output (12-24 V d.c.) |
| | O | 12 NPN open collector output (5 - 12 V d.c.) |
| | | 24 NPN open collector output (12-24 V d.c.) |
| | T | 12 Totem pole output (5 - 12 V d.c.) |
| | | 24 Totem pole output (12-24 V d.c.) |
| L | Line driver output (5 V d.c.) | |

(Note) *J is output only for A, B phase (line driver output: A, \bar{A} , B, \bar{B} phase). Pulses other than the ones in the chart are order-made

Number of pulses (resolution)

| Model | Number of pulses per revolution |
|-------|--|
| HE40H | *1, *2, *5, 10, *12, 15, 20, 25, 30, 40, 45, 50, 60, 75, 100, 120, 125, 150, 192, 200, 240, 250, 256, 300, 360, 400, 500, 512, 600, 800, 1000, 1024, |

※ Please contact us if you have any request for pulse production

ROTARY ENCODERS

HE40HB series

Specifications

| | | | | |
|---------------------------|--------------------------------|--|---|--|
| Model | | HE40HB | | |
| Appearance | |  | | |
| Electrical specifications | Output phase difference | | Phase difference between the phase A and B : T/4 ± T/8 (1 cycle of A phase=T) | |
| | Response speed | | Max. 200 kHz | |
| | Rated voltage | NPN voltage output | ※ By suffix code | |
| | | Open collector | 5-12 V d.c. ±5 % | |
| | | Totem pole output | 12-24 V d.c. ±5 % | |
| | | Line driver output | 5 / 12 / 24 V d.c. ±5 % | |
| | Current consumption | | Max. 60 mA, line driver output max. 30 mA (no load) | |
| | Connection | | Cable extended type | |
| | Control output | NPN voltage output | ● Load voltage : max. 30 V ● Load current: max. 30 mA ● Residual voltage : max. 0.4 V | |
| | | NPN open collector | | |
| | | Totem pole output | ● LOW (load current: max. 30mA residual voltage: max. 0.4V) ● HIGH (load current: max. 10mA, output voltage: above rated voltage - 2.5 V d.c.) | |
| | | Line driver output | ● LOW (load current: max. 20 mA, residual voltage: max. 0.4 V d.c.) ● HIGH (load current: max. 20 mA, residual voltage: min. 2.5V d.c.) | |
| | Response time | Voltage output | Max. 1 μs (wire length: 1.5 m, sinking current= max. 30 mA) | |
| | | Open collector | | |
| Totem pole output | | Max. 1 μs (wire length 1.5 m, sinking current= max. 10 mA.) | | |
| Line driver output | | Max. 1 μs (wire length: 1.5 m, sinking current= max. 30 mA) | | |
| Mechanical specifications | Starting torque | | 4×10 ⁻³ N.m | |
| | Moment of inertia | | 4×10 ⁻⁶ Kg·m ² max | |
| | Permissible shaft loading | | ● Radial : within 30 N ● Thrust : within 20 N | |
| | Max. number of revolutions | | 5,000 r/min | |
| Ambient specification | Insulation resistance | | Min. 100 MΩ (between the terminal and case 500 V d.c. mega standard) | |
| | Dielectric strength | | 800 V a.c. 60 Hz for 1 min (between the terminal and case) | |
| | Vibration resistance | | 10 ~ 55 Hz (cycle for 1 min), double amplitude : 1.5 mm, for 2 hours each in X, Y and Z directions | |
| | Shock resistance | | Max. 735 m/s ² | |
| | Ambient temperature & humidity | | -10 ~ 70 °C (without condensation), during storage : -25 ~ 85 °C, 35 ~ 85 % RH | |
| | Cable | | ● 5 P, Ø 5 mm, length : 1.5 m, shield cable ● Line driver type : 8P, Ø 5 mm, length : 1.5 m, shield cable | |
| Accessories | | Bracket | | |

Suffix code

| Model | Code | Content | |
|------------------------------|--|---|---|
| HE | <input type="checkbox"/> - <input type="checkbox"/> <input type="checkbox"/> <input type="checkbox"/> <input type="checkbox"/> <input type="checkbox"/> <input type="checkbox"/> | Blind Shaft Type Rotary Encoder (Incremental) | |
| Dimension | 40HB | 6 Outer diameter : Ø40 mm inner diameter : Ø6 mm | |
| | 8 Outer diameter : Ø40 mm inner diameter : Ø8 mm | | |
| | 10 Outer diameter : Ø40 mm inner diameter : Ø10 mm | | |
| | 12 Outer diameter : Ø40 mm inner diameter : Ø12 mm | | |
| Number of pulses | * | Refer to "Number of pulses (resolution)" | |
| Output signal (Output phase) | 2 | A, B phase output | |
| | 3 | A, B, Z phase output | |
| | 3C | A, B, Z̄ phase output | |
| | 4 | A, Ā, B, B̄ phase output | |
| | 6 | A, Ā, B, B̄, Z, Z̄ phase output | |
| Output circuit | N | 24 | NPN voltage output (12-24 V d.c.) |
| | | 12 | NPN voltage output (5 - 12 V d.c.) |
| | O | 24 | NPN open collector output (12-24 V d.c.) |
| | | 12 | NPN open collector output (5 - 12 V d.c.) |
| | T | 24 | Totem pole output (12-24 V d.c.) |
| | | 12 | Totem pole output (5 - 12 V d.c.) |
| | L | 5 | Line driver Output (5 V d.c.) |
| | | 12 | Line driver Output (12 V d.c.) |
| | 24 | Line driver Output (24 V d.c.) | |

(Note) *1 Is output only for A, B phase (line driver output: A, Ā, B, B̄ phase).
Pulses other than the ones in the chart are order-made

Number of pulses (resolution)

| Model | Number of pulses per revolution |
|--------|---|
| HE40HB | *1, *2, *5, 10, *12, 15, 20, 25, 30, 40, 45, 50, 60, 75, 100, 120, 125, 150, 192, 200, 240, 250, 256, 300, 360, 400, 500, 512, 600, 800, 1000, 1024 |

※ Please contact us if you have any request for pulse production

PSC series

Specifications

| Model | | PSC | |
|---------------------------|---|--|---|
| Appearance | |  | |
| Electrical specifications | Output phase difference | Phase difference between the phase A and B : $T/4 \pm T/8$ (1 cycle of A phase=T) | |
| | Response speed | Max. 100 KHz | |
| | Rated voltage | 5-12 V d.c. ($\pm 5\%$), 12-24 V d.c. ($\pm 5\%$) | |
| | Current consumption | Max. 60 mA | |
| | Connection | Cable extended type | |
| | Control output | Voltage and open collector outputs | ● Load voltage: max. 30 V, ● load current: max. 30 mA, ● Residual voltage: max. 0.4 V |
| | | Totem pole output | ● LOW (load current : max. 30 mA, residual voltage : max. 0.4 V) ● HIGH (load current : max. 10 mA, output voltage : above rated voltage - 1.5 V d.c.) |
| Response time | Max. 1 μ s (wire length: 1.5 m, sinking current= = 30 mA) | | |
| Mechanical specifications | Starting torque | Max. 200 gf·cm (19,600 u N·m) | |
| | Moment of inertia | Max. 800 g·cm ² (8×10^{-6} kg·m ²) | |
| | Permissible shaft loading | ● Radial : within 0.1 mm, ● Thrust : within 0.2 mm | |
| | Max. number of revolutions | 5,000 r/min | |
| | Bearing life | 1.2×10^7 (r/min) : time | |
| Ambient specification | Insulation resistance | Min. 500 M Ω (between the terminal and case) | |
| | Dielectric strength | 500 V a.c. 60 Hz for 1 min (between the terminal and case) | |
| | Vibration resistance | 10 - 55 Hz (cycle for 1 min), double amplitude : 1.5 mm, for 2 hours each in X, Y and Z directions | |
| | Shock resistance | Max. 75 G | |
| | Ambient temperature & humidity | -10 ~ 70 °C (without icing), during storage: -25 ~ 85 °C, 35 ~ 85 % RH | |
| | Cable | ● Number of strips: 5 P, ● thickness: \varnothing 5.0 mm, ● Length: 1.5 m, ● Shield cable | |
| | Weight (g) | 625 | |

| |
|----------------------|
| Axial |
| Hollow shaft type |
| Clogged hollow Axial |
| Wheel type |

Suffix code

| Model | Code | Content |
|-------------------------|---|---|
| PSC- | <input type="checkbox"/> <input type="checkbox"/> <input type="checkbox"/> <input type="checkbox"/> | Wheel Type Encoder |
| Min. length measurement | MA | 1 m |
| | MB | 1 cm |
| | MC | 1 mm |
| | YA | 1 YARD |
| | YB | 0.1 YARD |
| | YC | 0.01 YARD |
| Output signal | AB | A, B phase output (PSC-MA, YA), the others are A, B, Z Phase output |
| Output circuit | N | NPN voltage output |
| | O | NPN open collector |
| | T | Totem pole output |
| Power voltage | 12 | 12 V d.c. (5-12 V d.c.) |
| | 24 | 24 V d.c. (12-24 V d.c.) |

※ The codes PSC-MA and PSC-YA are A, B phase output. The others are A, B, Z phase output

THYRISTOR POWER REGULATORS

TPR-3

Specifications

| Model | TPR-3P | |
|--------------------------------|--|-------------------------|
| Appearance |  | |
| Power voltage | 220 V a.c. / 380 V a.c. / 440 V a.c. | |
| Power frequency | 50/60 Hz (common) | |
| Rated current | 200 A / 250 A / 320 A / 500 A | |
| Protective circuit | ● Fuse break alarm, ● Over current alarm, ● Overheating heat sink | |
| Applying load | Resistive load / Inductive load | |
| Control input | Current Input | 4-20 mA d.c. |
| | Voltage Input | 1-5 V d.c. |
| | Contact Input | ON/OFF |
| | External VR | External volume (10 kΩ) |
| Control type | ● Phase control, ● ON/OFF control | |
| Start type | Soft start / down | |
| Output voltage | More than 95 % of the Power voltage (In case of maximum current input) | |
| Cooling type | Forced cooling (200 A ~ 500 A), separate power supply for fan driving (320 A, 500 A) | |
| Display method | Display by LED light | |
| Insulation resistance | Min. 100 MΩ (Base on 500 V d.c. mega) | |
| Output adjustable range | 0 ~ 100 % | |
| Dielectric strength | 2,000 V a.c. 50/60 Hz for 1 min | |
| Line noise | Noise by noise simulator (2 kV) | |
| Ambient temperature & humidity | 0 ~ 40 °C, 35 ~ 85 % RH (without condensation) | |
| Storage temperature | -25 ~ 70 °C | |
| Weight (g) | 200/250 A: about 15 kg, 320 A: about 22 kg, 500 A: about 35 kg | |

Suffix code

| Model | Code | Content |
|---------------|---|-------------------------|
| TPR-3P | <input type="checkbox"/> <input type="checkbox"/> | 3-Phase Power Regulator |
| Power voltage | 220 | 220 V a.c. |
| | 380/440 | 380 V a.c. / 440 V a.c. |
| Rated current | 200 | 200 A |
| | 250 | 25 |
| | 320 | 320 A |
| | 500 | 500 A |

TPR-2G

NEW

Specifications

| Model | Low voltage | TPR-2G25L | TPR-2G35L | TPR-2G50L | TPR-2G70L |
|--------------------------------|---------------|--|-----------|----------------|-----------|
| | High voltage | TPR-2G25H | TPR-2G35H | TPR-2G50H | TPR-2G70H |
| Appearance | | | | | |
| Power voltage | Low voltage | 220 V a.c. | | | |
| | High voltage | 380 V a.c. | | | |
| Power frequency | | 50 Hz / 60 Hz (common) | | | |
| Rated current (40 °C standard) | | 25 A | 35 A | 50 A | 70 A |
| Applying load | | Resistive load | | | |
| Control Input | Current input | 4-20 mA d.c. (impedance : 100Ω) | | | |
| | Voltage input | - | | 1-5 V d.c. | |
| | Contact input | ON / OFF | | - | |
| | External VR | External volume (10 kΩ) | | | |
| Control method | | ● Phase control (shipment mode), ● Fixed cycle cycle control (optional), ● Variable cycle cycle control (optional) | | | |
| Movement type | | SOFT START / SOFT DOWN (Time 0 to 50 seconds) | | | |
| Output voltage | | More than 98 % of the Power voltage (In case of maximum current input) | | | |
| Cooling method | | Natural cooling | | Forced cooling | |
| Display method | | Display by LED | | | |
| Insulation resistance | | 500 V d.c. 100 MΩ | | | |
| Dielectric strength | | 2,500 V a.c. 50/60 Hz for 1 min | | | |
| Line noise | | Noise by noise simulator (Pulse width 1 us: ± 2kV) | | | |
| Ambient temperature | | 0~50 °C (However, no condensation) | | | |
| Ambient Humidity | | 30 ~ 85 % RH | | | |
| Storage temperature | | -25 ~ 70 °C | | | |
| Weight(g) | | 740 | | 1,730 | 1,750 |

General type
3-phase

New product
General single
phase

MINI
Slim type
Single-phase,
three-phase

Slim type
phase

3 channels
Each phase
control

Slim type
3-phase

Suffix code

| Model | Code | Content |
|---------------|---|------------------------------|
| TPR - 2G | <input type="checkbox"/> <input type="checkbox"/> | Single phase power regulator |
| Rated current | 25 | 25 A |
| | 35 | 35 A |
| | 50 | 50 A |
| | 70 | 70 A |
| Load voltage | L | 220 V a.c. 50/60 Hz |
| | H | 380 V a.c. 50/60 Hz |

THYRISTOR POWER REGULATORS

TPR-2M

Specifications

| Model | | Economical type | Advanced type | |
|----------------------|---------------------|--|---|--------------|
| | | Low voltage | Low voltage | High voltage |
| | | TPR-2ME25L | TPR-2MS25L | TPR-2MS25H |
| | | TPR-2ME35L | TPR-2MS35L | TPR-2MS35H |
| Appearance | |  | | |
| WXHxD (mm) | | 47.5×90.0×112.0 | | |
| Load Voltage | | 100-240 V a.c. | 100 - 440 V a.c. | |
| Circuit input power | | 100-240 V a.c. 3 W | 24 V d.c. 1 W | |
| Power frequency | | 50/60 Hz (common) | | |
| Rated current | | 25 A / 35 A | | |
| Control Input | Current input | 4-20 mA d.c. (impedance : 100 Ω) (Basic packages) | 4-20 mA d.c. (impedance : 100 Ω) (Option) | |
| | Voltage input | 1-5 V d.c. (Basic packages) | 1-5 V d.c. (Option) | |
| | Contact input | ON/OFF (Basic packages) | ON/OFF (Option) | |
| | External VR | External VR (10 kΩ) Simultaneous use of current and voltage input is not supported | - | |
| Applicable device | | TRIAC | SCR | |
| Control method | | ● Phase control (Basic), ● Variable Cycle control (Option) | | |
| Movement type | | SOFT START (60 sec), SOFT UP/DOWN (15 sec) / Adjust start time by SOFT VR | | |
| Output voltage | | More than 98 % of the Power voltage (In case of maximum current input) / Output limitation control by Power VR | | |
| Alarm function | | - | ● Relay contact output (overcurrent (CE), ● heat sink overheat (OT), ● power failure/heater break (PE), ● SCR short (PE) | |
| Display method (LED) | Check Output Volume | FIRE : Flicker speed directly proportional to output | | |
| | Check power | POWER: ON POWER | - | |
| | Alarm verification | - | CE (CURRENT ERROR) : Load current greater than 45 A | |
| | | - | OT (OVER TEMP) : Heat shield temperature above 85°C | |
| | | PE (power ERROR): Power error, Heater break | | |
| Cooling method | | Natural cooling | | |
| Weight (g) | | 322 | | |

Suffix code

| Model | Code | Content | |
|--|---|---------------------------------------|---|
| TPR-2M | <input type="checkbox"/> <input type="checkbox"/> <input type="checkbox"/> <input type="checkbox"/> | Single-Phase Mini Power Controller | |
| Type | E | Economical type | |
| | S | High function | |
| Rated current | 25 | 25 A | |
| | 35 | 35 A | |
| Power voltage | L | 100-240 V a.c. | |
| | H | 100 - 440 V a.c. (High function only) | |
| Selection specification (High function only) | C | 4-20 mA d.c. | Economic type: Basic specification High function: Selection specification (optional 1) |
| | V | 1-5 V d.c. | |
| | O | ON/OFF | |

* The circuit input voltage shall be applied separately. (Low pressure : 100-240 V a.c. / High pressure: 24 V d.c.)

TPR-3M

Specifications

| Model | TPR-3M25L | TPR-3M45L |
|--------------------------------|--|-----------|
| Appearance |  | |
| WXHxD (mm) | 110.0×157.5×150.0 | |
| Power Voltage | 100-240 V a.c. | |
| Circuit input power | 24 V d.c. 8 W | |
| Frequency of use | 50/60 Hz | |
| rated current | 25 A | 45 A |
| Applied Load | Resistance load | |
| Control Input | 4-20 mA d.c. (impedance: 100 Ω) | |
| Control method | Phase control (select variable cycle, fixed cycle control options) | |
| Output voltage | More than 98 % of the Power voltage (In case of maximum current input) / Output limitation control by Power VR | |
| Cooling method | Forced cooling (24 V d.c. FAN) | |
| Display method | 4 LEDs display status and alarm conditions | |
| Insulation resistance | Above 100 ((based on 500 Vd.c. mega) | |
| Voltage withstand | 2,500Va.c. 50/60 Hz For 1 min | |
| Line noise | Noise by noise simulator (2,000 V) | |
| Storage temperature | -30 ~ 90 °C | |
| Ambient temperature & humidity | -20 ~ 80 °C, 45 ~ 85% RH (No condensation) | |
| Weight (g) | 1,756 | |

General type
3-phase

New product
General single
phase

MINI
Slim type
Single-phase,
three-phase

Slim type
phase

3 channels
Each phase
control

Slim type
3-phase

Suffix code

| Model | Code | Content |
|---------------|--|----------------------------------|
| TPR-3M | <input type="checkbox"/> <input type="checkbox"/> <input type="checkbox"/> | 3-Phase mini power regulator |
| Rated current | 25 | 25 A |
| | 45 | 45 A |
| Power Voltage | L | 100-240 V a.c. (For low voltage) |
| Option | IS | Power insulation type |

※ Option -IS type is a product that can connect up to 5 in series with 1 temperature controller and power supply (SMPS).
The general type is 24 V d.c. The partial power circuit is non-insulated and requires 1:1 connection with the temperature controller.

THYRISTOR POWER REGULATORS

TPR-2SL

Specifications

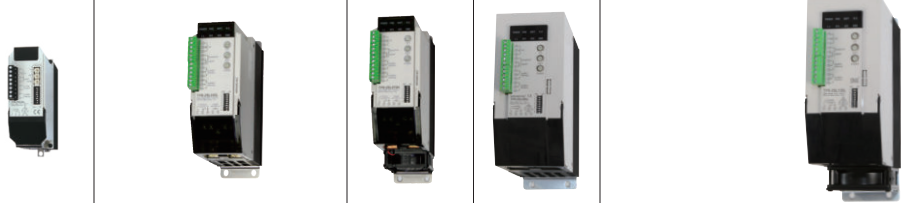
| Model | Low voltage | TPR-2SL 025L | TPR-2SL 040L | TPR-2SL 055L | TPR-2SL 070L | TPR-2SL 090L | TPR-2SL 110L | TPR-2SL 130L | TPR-2SL 160L | TPR-2SL 200L |
|--------------------------------|--|-----------------------------------|------------------|----------------|------------------|---------------------------|------------------|--------------|------------------|--------------|
| | High voltage | TPR-2SL 025H | TPR-2SL 040H | TPR-2SL 055H | TPR-2SL 070H | TPR-2SL 090H | TPR-2SL 110H | TPR-2SL 130H | TPR-2SL 160H | TPR-2SL 200H |
| Appearance |  | | | | | | | | | |
| WXHD (mm) | 47.0×148.0×151.7 | | 60.0×183.0×172.1 | | 60.0×203.0×172.1 | | 85.0×219.0×205.1 | | 85.0×245.5×205.1 | |
| Power voltage | Low voltage | 100-240 V a.c. | | | | | | | | |
| | High voltage | 380-440 V a.c. | | | | | | | | |
| Circuit input power | 6 W | | | 16 W | | | 20 W | | | |
| | 100-240 V a.c. | | | | | | | | | |
| Power frequency | 50/60 Hz (Common) | | | | | | | | | |
| Rated current (40 °C standard) | 25A | 40 A | 55 A | 70 A | 90 A | 110 A | 130 A | 160 A | 200 A | |
| Fuse installation | None (optional) | | | | | Built-in fast acting fuse | | | | |
| Applying load | Resistive load | | | | | | | | | |
| Control Input | Current input | 4-20 mA d.c. (impedance : 100 Ω) | | | | | | | | |
| | Voltage input | 1-5 V d.c. (option : 0-10 V d.c.) | | | | | | | | |
| | Contact input | ON/OFF | | | | | | | | |
| | External VR | External volume (10 kΩ) | | | | | | | | |
| Control method | ● Phase control, ● Fixed cycle control, ● Variable cycle control, ● ON/OFF control | | | | | | | | | |
| Movement type | SOFT START / SOFT UP, DOWN | | | | | | | | | |
| Output voltage | More than 98 % of the Power voltage (In case of maximum current input) | | | | | | | | | |
| Cooling method | Natural cooling | | | Forced cooling | Natural cooling | Forced cooling | | | | |
| Display method | Display by LED | | | | | | | | | |
| Insulation resistance | Min. 100 MΩ (based on 500 V d.c. mega) | | | | | | | | | |
| Output control range | 0 ~ 100 % | | | | | | | | | |
| Dielectric strength | 3000 V a.c. 50/60 Hz for 1 min | | | | | | | | | |
| Line noise | Noise by noise simulator (3000 V) | | | | | | | | | |
| Ambient temperature & humidity | 0 ~ 40 °C, 30 ~ 85 % RH (without condensation) | | | | | | | | | |
| Storage temperature | -25 ~ 70 °C | | | | | | | | | |
| Weight (g) | 1,388 | 1,388 | | 1,478 | 2,820 | 3,100 | | | | |

Suffix code

| Model | Code | | | | Content |
|---------------|--------------------------|--------------------------|--------------------------|--------------------------|--|
| TPR-2SL | <input type="checkbox"/> | <input type="checkbox"/> | <input type="checkbox"/> | <input type="checkbox"/> | Slim Type Single-Phase Thyristor Power Regulator |
| Rated current | 025 | | | | 25 A |
| | 040 | | | | 40 A |
| | 055 | | | | 55 A |
| | 070 | | | | 70 A |
| | 090 | | | | 90 A |
| | 110 | | | | 110 A |
| | 130 | | | | 130 A |
| | 160 | | | | 160 A |
| Power voltage | L | | | | 100-240 V a.c. (Low voltage) |
| | H | | | | 380-440 V a.c. (High voltage) |
| Option | | C | | | RS485 |
| | | | F | | Built-in fuse type (for 25/40/55/70 A models) |

* The circuit need 100 - 240 V a.c. voltage power separately.

TPR-3SL-EP

Specifications

| Model | Low voltage | TPR-3SL040L-EP | TPR-3SL055L-EP | TPR-3SL070L-EP | TPR-3SL090L-EP | TPR-3SL130L-EP | TPR-3SL160L-EP |
|--------------------------------|--|--|----------------|----------------|----------------|----------------|----------------|
| | High voltage | TPR-3SL040H-EP | TPR-3SL055H-EP | TPR-3SL070H-EP | TPR-3SL090H-EP | TPR-3SL130H-EP | TPR-3SL160H-EP |
| Appearance |  | | | | | | |
| | | | | | | | |
| Power voltage | Low voltage | 100-240 V a.c. | | | | | |
| | High voltage | 100-440 V a.c. | | | | | |
| Circuit input power | | 100-240 V a.c. 18 W | | | | | |
| Power frequency | | 50/60 Hz (Common) | | | | | |
| Rated current | | 40 A | 55 A | 70 A | 90 A | 130 A | 160 A |
| Applying load | | Resistive load | | | | | |
| Current input | | 4-20 mA d.c. (Impedance : 100 Ω) | | | | | |
| Control type | | ● Phase control, ● Fixed cycle control, ● Variable cycle control, ● ON/OFF control | | | | | |
| Movement type | | SOFT START / SOFT UP, DOWN | | | | | |
| Output voltage | | More than 98 % of the Power voltage (In case of maximum current input) | | | | | |
| Cooling method | | Forced cooling | | | | | |
| Display method | | Display by LED | | | | | |
| Insulation resistance | | Min. 100 MΩ (500 V d.c. Mega standard) | | | | | |
| Output control range | | 0 ~ 100 % | | | | | |
| Dielectric strength | | 3,000 V a.c. 50/60 Hz for 1 min | | | | | |
| Line noise | | Noise by noise simulator (2500 V) | | | | | |
| Ambient temperature & humidity | | 0 ~ 40 °C, 30 ~ 85 % RH (without condensation) | | | | | |
| Storage temperature | | -25 ~ 70 °C | | | | | |
| Weight (g) | | 4,324 | | | 9,194 | | 9,288 |

General type
3-phase

New product
General single
phase

MINI
Slim type
Single-phase,
three-phase

Slim type
phase

3 channels
Each phase
control

Slim type
3-phase

Suffix code

| Model | Code | Content |
|---------------|--|--|
| TPR-3SL | <input type="checkbox"/> <input type="checkbox"/> - <input type="checkbox"/> | 3-Channel Each Phase Control Thyristor Power Regulator |
| Rated current | 040 | 40 A |
| | 055 | 55 A |
| | 070 | 70 A |
| | 090 | 90 A |
| | 130 | 130 A |
| | 160 | 160 A |
| Power voltage | L | 100-240 V a.c. (Low voltage) |
| | H | 100-440 V a.c. (High voltage) |
| Option | EP | Each phase control (individual control of 3 devices) |

※ Circuit and fan need 100 - 240 V a.c. voltage power separately.

※ For 130 A, 160 A products, the fan need 24 V d.c. voltage power.

THYRISTOR POWER REGULATORS

TPR-3CH-EC

NEW

Specifications

| Model | Low voltage | TPR-3CH040L-EC | TPR-3CH055L-EC | TPR-3CH070L-EC | TPR-3CH090L-EC | TPR-3CH130L-EC | TPR-3CH160L-EC | |
|-------------------------|--|----------------|----------------|----------------|----------------|----------------|----------------|--|
| | High voltage | TPR-3CH040H-EC | TPR-3CH055H-EC | TPR-3CH070H-EC | TPR-3CH090H-EC | TPR-3CH130H-EC | TPR-3CH160H-EC | |
| Appearance |  | | | | | | | |
| Power voltage | Low voltage | 100-240 V a.c. | | | | | | |
| | High voltage | 100-440 V a.c. | | | | | | |
| Circuit power | Input voltage | 24 V d.c. | | | | | | |
| | Current consumption | 208 mA | | | 458 mA | | | |
| | Power Consumption | 5 W | | | 11 W | | | |
| Frequency used | 50/60 Hz (Common) | | | | | | | |
| Rated current | 40 A | 55 A | 70 A | 90 A | 130 A | 160 A | | |
| Applied load | Resistance load | | | | | | | |
| Control method | ● Phase control, ● Fixed cycle cycle control, ● Variable cycle cycle control | | | | | | | |
| Starting method | SOFT START / DOWN | | | | | | | |
| Output voltage | 98% or more of power supply voltage (at maximum current input) | | | | | | | |
| Cooling method | Forced cooling | | | | | | | |
| How to display | Output indication by LED | | | | | | | |
| Insulation Resistance | 100 MΩ or more (based on 500 V d.c. mega) | | | | | | | |
| Output adjustment range | 0 ~ 100 % | | | | | | | |
| Withstand voltage | 3,000 V a.c. 1 minute at 50/60 Hz | | | | | | | |
| Line noise | Noise by noise simulator (2,500 V) | | | | | | | |
| Ambient temperature | 0 ~ 40 °C (with no condensation) | | | | | | | |
| Ambient Humidity | 30 ~ 85 % RH | | | | | | | |
| Storage temperature | -25 °C ~ 70 °C | | | | | | | |
| Weight(g) | 4,324 | | | 9,194 | | 9,288 | | |

Suffix code

| Model | Code | Content |
|---------------|--|--|
| TPR-3CH | <input type="checkbox"/> <input type="checkbox"/> - <input type="checkbox"/> | 3-Channel Each Phase Control Thyristor Power Regulator |
| Rated current | 040 | 40 A |
| | 055 | 55 A |
| | 070 | 70 A |
| | 090 | 90 A |
| | 130 | 130 A |
| | 160 | 160 A |
| Power voltage | L | 100-240 V a.c. (Low voltage) |
| | H | 100-440 V a.c. (High voltage) |
| Option | EC | EtherCAT communication control |

* Circuit power and FAN power are separately 24 V d.c. Voltage must be applied.

TPR-3SL CE

Specifications

| Model | Low voltage | TPR-3SL040L | TPR-3SL055L | TPR-3SL070L | TPR-3SL090L | TPR-3SL130L | TPR-3SL160L |
|--------------------------------|--|---------------------------------|-------------|---------------------|-------------|-------------------|-------------|
| | High voltage | TPR-3SL040H | TPR-3SL055H | TPR-3SL070H | TPR-3SL090H | TPR-3SL130H | TPR-3SL160H |
| Appearance |  | | | | | | |
| WXHxD(mm) | 110.0×249.5×213.7 | | | 110.0×249.5×213.7 | | 173.0×300.5×239.1 | |
| Power voltage | Low voltage | 100-240 V a.c. | | | | | |
| | High voltage | 380-440 V a.c. | | | | | |
| Circuit input power | 100-240 V a.c. 18 W | | | 100-240 V a.c. 20 W | | | |
| Power frequency | 50/60 Hz (Common) | | | | | | |
| Rated current | 40 A, 55 A, 70 A, 90 A, 130 A, 160 A | | | | | | |
| Applying load | Resistive load | | | | | | |
| Control Input | Current input | 4-20mA d.c. (Impedance : 100 Ω) | | | | | |
| | Voltage input | 1-5 V d.c. | | | | | |
| | Contact input | ON / OFF | | | | | |
| | External VR | External volume (10 KΩ) | | | | | |
| Control method | ● Phase control, ● Fixed cycle cycle control, ● Variable cycle cycle control, ● ON/OFF control | | | | | | |
| Movement type | SOFT START / SOFT UP, DOWN | | | | | | |
| Output voltage | More than 98 % of the Power voltage (In case of maximum current input) | | | | | | |
| Cooling method | Natural cooling (40 A, 55 A), Forced cooling (70 A, 90 A, 130 A, 160 A) | | | | | | |
| Display method | Display by LED | | | | | | |
| Insulation resistance | Min. 100 MΩ (Base on 500 V d.c. mega) | | | | | | |
| Output control range | 0 ~ 100 % | | | | | | |
| Dielectric strength | 3,000 V a.c. 50/60 Hz for 1 min | | | | | | |
| Line noise | Noise by noise simulator (2500 V) | | | | | | |
| Ambient temperature & humidity | 0 ~ 40 °C, 30 ~ 85 % RH (without condensation) | | | | | | |
| Storage temperature | -25 ~ 70 °C | | | | | | |
| Weight (g) | 4,044 | | 4,324 | | 9,100 | | 9,194 |

General type
3-phase

New product
General single
phase

MINI
Slim type
Single-phase,
three-phase

Slim type
phase

3 channels
Each phase
control

Slim type
3-phase

Suffix code

| Model | Code | Content |
|---------------|--|-----------------------------------|
| TPR-3SL | <input type="checkbox"/> <input type="checkbox"/> - <input type="checkbox"/> | Slim Type 3-Phase Power Regulator |
| Rated current | 040 | 40 A |
| | 055 | 55 A |
| | 070 | 70 A |
| | 090 | 90 A |
| | 130 | 130 A |
| | 160 | 160 A |
| Power voltage | L | 100-240 V a.c. (Low voltage) |
| | H | 380-440 V a.c. (High voltage) |
| Option | - | Fuse built-in |
| | N | No fuse |

※ Circuit and fan need 100 - 240 V a.c. voltage power separately.

SOLID STATE RELAYS

SSR-2B/2C



NEW

Specifications

| Model | | 3 contacts | SSR-2B252Z | SSR-2B402Z | |
|-----------------------|---|--------------------|---------------------|------------|--|
| | | 2 contacts | SSR-2C252Z | SSR-2C402Z | |
| Appearance | | | | | |
| Load | Load voltage | 90-264 V a.c. | | | |
| | Peak voltage (non-repetitive) | 600 V | | | |
| | Rated load current | 25 A | 40 A | | |
| | Frequency | 50/60 Hz(Common) | | | |
| | Closing current (8.3 ms non-repetitive) | 260 A | 420 A | | |
| | Leakage current | 10 mA or less | | | |
| | Output ON Voltage drop | 3 contacts | 2.5 V (RMS) or less | | |
| | | 2 contacts | 1.8 V (RMS) or less | | |
| Input | Rated voltage (Circuit voltage) | 3 contacts | 24 V d.c. | | |
| | | 2 contacts | None | | |
| | Voltage range | 4-32 V d.c. | | | |
| | Impedance | 4 kΩ or less | | | |
| | Operating voltage | 3 V d.c. More than | | | |
| Return voltage | 1.5 V d.c. Below | | | | |
| Temperature detection | 3 contacts | 80 °C | 80 °C | | |
| | 2 contacts | 60 °C / 80 °C | 60 °C / 80 °C | | |
| Response speed | 1/2 Cycle + 1 ms max | | | | |
| Insulation Resistance | 500 V d.c. 100 MΩ (Between input and output and case) | | | | |
| Withstand voltage | 2,500 V a.c. (1 minute at 60 Hz) | | | | |
| Vibration resistance | 10 -55 Hz, double amplitude: 1.5 mm, 2 hours in each of X, Y and Z directions | | | | |
| Shock resistance | 1,000 ٪, X · Y · Z 3 times each direction | | | | |
| Storage temperature | -30 ~ 90 °C | | | | |
| Ambient temperature | -20 ~ 80 °C (However, no condensation) | | | | |
| Ambient Humidity | 45 ~ 85 % RH | | | | |
| Applied standard | IEC 62314 | | | | |
| Subordinate category | LC A | | | | |
| Protection class | IP20 | | | | |
| Pollution level | Level 2 | | | | |
| Weight(g) | 670 | | 900 | | |

Configuration

| Model | Code | | | | | Content |
|--------------------|--------------------------|--------------------------|--------------------------|--------------------------|--------------------------|-------------------------|
| SSR- | <input type="checkbox"/> | <input type="checkbox"/> | <input type="checkbox"/> | <input type="checkbox"/> | <input type="checkbox"/> | Solid State Relay |
| phase | 2 | | | | | phase |
| Contact | B | | | | | Bimetal input 3 Contact |
| | C | | | | | 2 Contact |
| Rated load current | 25 | | | | | 25 A |
| | 40 | | | | | 40 A |
| Used load voltage | 2 | | | | | 90-264 V a.c. |
| How to operate | | | | Z | | Zero cross switching |

SSR-2 series CE

NEW

Specifications

- DC input - AC load

| Model | Low voltage | SSR-2D102Z | SSR-2D202Z | SSR-2D302Z | SSR-2D402Z | |
|--------------------------------|--------------------------------------|--|-------------------------------------|------------|------------|------|
| | High voltage | SSR-2D104Z | SSR-2D204Z | SSR-2D304Z | SSR-2D404Z | |
| Appearance | |  | | | | |
| WXHxD(mm) | | 42.0×64.0×27.3 | | | | |
| Load | Load voltage range | Low voltage | 90-264 V a.c. | | | |
| | | High voltage | 90-480 V a.c. | | | |
| | Peak Voltage (Non-repetition) | Low voltage | 600 V | | | |
| | | High voltage | 800 V | 1,200 V | | |
| | Rated load current | | 10 A | 20 A | 30 A | 40 A |
| | Frequency | | 50/60 Hz (Common) | | | |
| | Surge current (8.3 ms No repetition) | Low voltage | 170 A | 260 A | 420 A | |
| | | High voltage | 170 A | 250 A | 370 A | |
| | Leakage current | | Max. 20 mA | | | |
| | Output ON voltage dropping | | Less than 1.6 V (R.M.S) | | | |
| Input | Rated Voltage | | 5-24 V d.c. | | | |
| | Operating voltage range | | 4.6-32 V d.c. | | | |
| | Impedance | | 4 kΩ or less | | | |
| | Operation voltage | | 4.6 V d.c. More than | | | |
| | Input current | | Constant-current system : 8 mA (±3) | | | |
| Response Time | | 1/2 Cycle + 1 ms max ("R" type below 1 ms) | | | | |
| Insulating Resistance | | 500 V d.c., 100 MΩ (between the input / output and case) | | | | |
| Dielectric strength | | 2,500 V a.c. (60 Hz for 1 min) | | | | |
| Vibration resistance | | 10 - 55 Hz, double amplitude : 1.5 mm, X,Y, and Z direction for 2 hours | | | | |
| Shock resistance | | 1,000 m/s ² , X,Y,Z each axis 3 times | | | | |
| Storage temperature | | -30 ~ 90 °C | | | | |
| Ambient temperature & humidity | | -5 ~ 40 °C, 45 ~ 85 % RH (without condensation) | | | | |
| Pollution degree | | Level 2 | | | | |
| purpose of use | | Resistive load / inductive load | | | | |
| Accepted standard | | IEC 62314 | | | | |
| Weight (g) | | 89 | | | | |

New product Phase

General type phase

Multifunctional 3-phase Radiator integrated type

New product 3-phase

General type 3-phase

Slim type phase Radiator integrated type

Slim type 2-line cutoff Radiator integrated type

Slim type 3-phase Radiator integrated type

Heatsink, PCB board phase

SOLID STATE RELAYS

● AC input - AC load

| Model | | Low voltage | SSR-2A102Z | SSR-2A202Z | SSR-2A302Z | SSR-2A402Z |
|--------------------------------|--------------------------------------|--|-------------------------------------|------------|------------|------------|
| | | High voltage | SSR-2A104Z | SSR-2A204Z | SSR-2A304Z | SSR-2A404Z |
| Appearance | |  | | | | |
| WXHxD(mm) | | 42.0×64.0×27.3 | | | | |
| Load | Load voltage range | Low voltage | 90-264 V a.c. | | | |
| | | High voltage | 90-480 V a.c. | | | |
| | Peak Voltage (Non-repetition) | Low voltage | 600 V | | | |
| | | High voltage | 800 V | 1,200 V | | |
| | Rated load current | | 10 A | 20 A | 30 A | 40 A |
| | Frequency | | 50/60 Hz (Common) | | | |
| | Surge current (8.3 ms No repetition) | Low voltage | 170 A | 260 A | 420 A | |
| | | High voltage | 170 A | 250 A | 370 A | |
| | Leakage current | | Max. 20 mA | | | |
| | Output ON voltage dropping | | Less than 1.6 V (R.M.S) | | | |
| Input | Rated Voltage | | 100-240 V a.c. | | | |
| | Operating voltage range | | 70-264 V a.c. | | | |
| | Impedance | | 40 kΩ or less | | | |
| | Operation voltage | | 70 V a.c. More than | | | |
| | Input current | | Constant-current system : 8 mA (±3) | | | |
| Response Time | | 1/2 Cycle + 1 ms max ("R" type below 1 ms) | | | | |
| Insulating Resistance | | 500 V d.c., 100 MΩ (between the input / output and case) | | | | |
| Dielectric strength | | 2,500 V a.c. (60 Hz for 1 min) | | | | |
| Vibration resistance | | 10 - 55 Hz, double amplitude : 1.5 mm, X,Y, and Z direction for 2 hours | | | | |
| Shock resistance | | 1,000 m/s ² , X,Y,Z each axis 3 times | | | | |
| Storage temperature | | -30 ~ 90 °C | | | | |
| Ambient temperature & humidity | | -5 ~ 40 °C, 45 ~ 85 % RH (without condensation) | | | | |
| Pollution degree | | Level 2 | | | | |
| purpose of use | | Resistive load / inductive load | | | | |
| Accepted standard | | IEC 62314 | | | | |
| Weight (g) | | 89 | | | | |

Suffix code

| Model | Code | Content |
|--------------------|---|---|
| SSR-2 | <input type="checkbox"/> <input type="checkbox"/> <input type="checkbox"/> <input type="checkbox"/> | Single-phase general type solid state relay |
| Input voltage | D | 5-24 V d.c. |
| | A | 100-240 V a.c. |
| Rated load current | 10 | 10 A |
| | 20 | 20 A |
| | 30 | 30 A |
| | 40 | 40 A |
| Used load voltage | 2 | 90-264 V a.c. (Low voltage) |
| | 4 | 90-480 V a.c. (High voltage) |
| How it works | Z | Zero cross switching (standard product) |
| | R | Random switching |

HSR-2 series

Specifications

● DC input - AC load

| Model | | Low voltage | HSR-2D102□ | HSR-2D202□ | HSR-2D302□ | HSR-2D402□ | HSR-2D502□ | HSR-2D702□ |
|----------------------------------|--------------------------------------|--|---------------------------------------|------------|------------|-----------------|------------|------------|
| | | High voltage | HSR-2D104□ | HSR-2D204□ | HSR-2D304□ | HSR-2D404□ | HSR-2D504□ | HSR-2D704□ |
| Appearance | |  | | | | | | |
| WXHxD(mm) | | 44.0×64.0×28.6 | | | | | | |
| Load | Usage Load Voltage | Low voltage | 90-264 V a.c. | | | | | |
| | | High voltage | 90-480 V a.c. | | | | | |
| | Peak voltage (Non-repeating) | Low voltage | 600 V | | | | 800 V | |
| | | High voltage | 800 V | 1,200 V | | | | |
| | Rated load current | | 10 A | 20 A | 30 A | 40 A | 50 A | 70 A |
| | Frequency | | 25-65 Hz | | | | | |
| | Input current (8.3 ms non-repeating) | Low voltage | 170 A | 250 A | 315 A | | 580 A | |
| | | High voltage | 170 A | 250 A | 350 A | 370 A | 580 A | |
| | Leakage current | Low voltage | 15 mA | | | | | |
| | | High voltage | 20 mA | | | | | |
| Output ON voltage drop | | 1.3 V | 1.6 V | 1.8 V | | | | |
| Input | Rated voltage | | 5-24 V d.c. | | | | | |
| | Operating voltage range | | 4-32 V d.c. | | | | | |
| | Impedance | | 4 kΩ or less | | | | | |
| | Operating voltage | | 3 V d.c. More than | | | | | |
| | Current input | | Constant current method : 10 mA (± 3) | | | | | |
| Response time | | 1/2 cycle +1 ms max (1ms or less) | | | | | | |
| Insulation Resistance | | 500 V d.c., 100 MΩ (Between input and output and case) | | | | | | |
| Voltage withstand | | 2500 V a.c.(1 minute at 60 Hz) | | | | | | |
| Vibration resistance | | 10-55 Hz, double amplitude : 1.5 mm X, Y, Z directions for 2 hours each | | | | | | |
| Shock resistance | | 1000 m/s ² X, Y, Z directions 3 times each | | | | | | |
| Storage temperature | | -30 ~ 90 °C | | | | | | |
| Ambient temperature and humidity | | -20 ~ 80 °C, 45 ~ 85% RH (without condensation) | | | | | | |
| Weight (g) | Radiator detachable type | | 150 | | | | | |
| | Radiator integrated type | | For 50 A: 1,400 | | | For 70 A: 2,050 | | |

New product Phase

General type phase

Multifunctional 3-phase Radiator integrated type

New product 3-phase

General type 3-phase

Slim type phase Radiator integrated type

Slim type 2-line cutoff Radiator integrated type

Slim type 3-phase Radiator integrated type

Heatsink, PCB board phase

SOLID STATE RELAYS

● DC input - AC load

| Model | | Low voltage | HSR-2A102□ | HSR-2A202□ | HSR-2A302□ | HSR-2A402□ | HSR-2A502□ | HSR-2A702□ |
|----------------------------------|--------------------------------------|--|-------------------------|------------|------------|------------------|------------|------------|
| | | High voltage | HSR-2A104□ | HSR-2A204□ | HSR-2A304□ | HSR-2A404□ | HSR-2A504□ | HSR-2A704□ |
| Appearance | |  | | | | | | |
| WXHxD(mm) | | 44.0×64.0×28.6 | | | | | | |
| Load | Usage Load Voltage | Low voltage | 90-264 V a.c. | | | | | |
| | | High voltage | 90-480 V a.c. | | | | | |
| | Peak voltage (Non-repeating) | Low voltage | 600 V | | | | 800 V | |
| | | High voltage | 800 V | 1,200 V | | | | |
| | Rated load current | | 10 A | 20 A | 30 A | 40 A | 50 A | 70 A |
| | Frequency | | 25-65 Hz | | | | | |
| | Input current (8.3 ms non-repeating) | Low voltage | 170 A | 250 A | 315 A | | 580 A | |
| | | High voltage | 170 A | 250 A | 350 A | 370 A | 580 A | |
| | Leakage current | Low voltage | 15 mA | | | | | |
| | | High voltage | 20 mA | | | | | |
| Output ON voltage drop | | 1.3 V | 1.6 V | 1.8 V | | | | |
| Input | Rated voltage | | 100-240 V a.c. | | | | | |
| | Operating voltage range | | 90-264 V a.c. | | | | | |
| | Impedance | | 40 kΩ or less | | | | | |
| | Operating voltage | | 72 V a.c. More than | | | | | |
| | Current input | | 240 V a.c. / 9 mA (± 4) | | | | | |
| Response time | | 1/2 cycle +1 ms max (1ms or less) | | | | | | |
| Insulation Resistance | | 500 V d.c., 100 MΩ (Between input and output and case) | | | | | | |
| Voltage withstand | | 2500 V a.c.(1 minute at 60 Hz) | | | | | | |
| Vibration resistance | | 10-55 Hz, double amplitude : 1.5 mm X, Y, Z directions for 2 hours each | | | | | | |
| Shock resistance | | 1000 m/s² X, Y, Z directions 3 times each | | | | | | |
| Storage temperature | | -30 ~ 90 °C | | | | | | |
| Ambient temperature and humidity | | -20 ~ 80 °C, 45 ~ 85% RH (without condensation) | | | | | | |
| Weight (g) | Radiator detachable type | | 150 | | | | | |
| | Radiator integrated type | | For 50 A : 1,400 | | | For 70 A : 2,050 | | |

Suffix code

| Model | Code | Content |
|----------------------------|-----------|--|
| HSR-2 | □ □ □ □ □ | Single phase solid state relay |
| Voltage input | D | 4-32 V d.c. |
| | A | 90-264 V a.c. |
| Rated load current | 10 | 10 A |
| | 20 | 20 A |
| | 30 | 30 A |
| | 40 | 40 A |
| | 50 | 50 A |
| | 70 | 70 A |
| Load voltage | 2 | 90-264 V a.c. (Low voltage) |
| | 4 | 90-480 V a.c. (High voltage) |
| The mode of operationally | Z | Zero cross switching |
| | R | Random switching |
| W/W with radiator attached | | No radiator |
| | T | Radiator integrated type (50 A, 70 A only) |

SSR-3F

NEW

Specifications

| Model | | SSR-3F252Z | SSR-3F352Z | SSR-3F452Z |
|---|---------------------------------|--|------------|------------|
| Appearance | |  | | |
| Usage load voltage | | 90-264 V a.c. | | |
| Peak voltage (non-repetitive) | | 600 V | | 1600 V |
| Rated load current | | 25 A | 35 A | 45 A |
| Frequency | | 50/60Hz (Common) | | |
| Closing current (8.3 ms non-repetitive) | | 220 A | 330 A | 450 A |
| Applied load | | Resistance load | | |
| Leakage current | | 10 mA or less | | |
| Output ON voltage drop | | 1.8 V (R.M.S) or less | | |
| Input | Rated voltage (circuit voltage) | 24 V d.c. 4W | | |
| | Voltage range | 7 - 32 V d.c. | | |
| | Impedance | 4 kΩ or less | | |
| Response speed | | 1/2 Cycle + 1 ms max. | | |
| Insulation Resistance | | 500 V d.c. 100MΩ | | |
| Voltage withstand | | 2,500 V a.c. 50/60 Hz for 1 minute | | |
| Vibration resistance | | 10 -55 Hz, double amplitude : 1.5mm, 2 hours in each of X, Y and Z directions | | |
| Shock resistance | | 1,000 m/s ² , 3 times in each of X, Y and Z directions | | |
| Storage temperature | | -30 ~ 90 °C | | |
| Ambient temperature | | -20~80 °C(without condensation) | | |
| Ambient Humidity | | 45~85 % R.H. | | |
| Weight (g) | | 1,800 | | |

New product
Phase

General type
phase

Multifunctional
3-phase
Radiator
integrated type

New product
3-phase

General type
3-phase

Slim type
phase
Radiator
integrated type

Slim type
2-line cutoff
Radiator
integrated type

Slim type
3-phase
Radiator
integrated type

Heatsink,
PCB board
phase

Suffix code

| Model | Code | Content |
|---------------|--------|---|
| SSR-3F | □ □ -□ | 3-phase multifunctional solid state relay |
| Rated current | 25 | 25 A |
| | 35 | 35 A |
| | 45 | 45 A |
| Power Voltage | 2 | 90 - 264 V a.c. |
| Options | Z | Zero-cross switching |

SOLID STATE RELAYS

SSR-3 series

Specifications

- DC Input - AC Load

| Model | | Low voltage | SSR-3D102Z | SSR-3D202Z | SSR-3D302Z | SSR-3D402Z |
|----------------------------------|--------------------------------------|--|-------------------------------------|------------|------------|------------|
| | | High voltage | SSR-3D104Z | SSR-3D204Z | SSR-3D304Z | SSR-3D404Z |
| Appearance | |  | | | | |
| W X H X D (mm) | | 109.0×60.0×31.3 | | | | |
| Load | Usage load voltage | Low voltage | 90-264 V a.c. | | | |
| | | High voltage | 90-480 V a.c. | | | |
| | Peak voltage (Non-repeating) | Low voltage | 600 V | | | |
| | | High voltage | 800 V | 1,200 V | | |
| | Rated load current | | 10 A | 20 A | 30 A | 40 A |
| | Frequency | | 50/60 Hz (Common) | | | |
| | Input current (8.3 ms non-repeating) | Low voltage | 170 A | 260 A | 420 A | |
| | | High voltage | 170 A | 250 A | 370 A | |
| Leakage current | | 20 mA or less | | | | |
| Output ON voltage drop | | 1.6 V (RMS) or less | | | | |
| Input | Rated voltage | | 5-24 V d.c. | | | |
| | Operating voltage range | | 4.6-32 V d.c. | | | |
| | Impedance | | 4 kΩ or less | | | |
| | Operating voltage | | 4.6 V d.c. More than | | | |
| | Current input | | Constant current method: 12 mA (±3) | | | |
| Response time | | 1/2 Cycle + 1 ms max ("R" type 1 ms or less) | | | | |
| Insulation Resistance | | 500 V d.c., 100 MΩ (between input and output and case) | | | | |
| Voltage withstand | | 2,500 V a.c. (1 minute at 60 Hz) | | | | |
| Vibration resistance | | 10-55 „, width of retrofit : 1.5 mm, X, Y, and Z for 2 hours each. | | | | |
| Shock resistance | | 1,000 m/s ² , 3 times in each of X, Y, and Z directions | | | | |
| Storage temperature | | -30 ~ 90 °C | | | | |
| Ambient temperature and humidity | | -5 ~ 40 °C, 45 ~ 85 % RH (without condensation) | | | | |
| Pollution degree | | Level 2 | | | | |
| Use Purpose | | resistive/inductive loads | | | | |
| Application Specification | | IEC 62314 | | | | |
| Weight (g) | | 227 | | | | |

Suffix code

| Model | Code | Content |
|---------------------------|---|-----------------------------------|
| SSR-3 | <input type="checkbox"/> <input type="checkbox"/> <input type="checkbox"/> <input type="checkbox"/> | 3-phase, normal contactless relay |
| Input voltage | D | 5-24 V d.c. |
| | A | 100-240 V a.c. |
| Rated load current | 10 | 10 A |
| | 20 | 20 A |
| | 30 | 30 A |
| | 40 | 40 A |
| Used load voltage | 2 | 90-264 V a.c. (Low voltage) |
| | 4 | 90-480 V a.c. (High voltage) |
| The mode of operationally | Z | Zero Cross Switching (Standard) |
| | R | Random switching |



● AC Input - AC Load

| Model | | Low voltage | SSR-3A102Z | SSR-3A202Z | SSR-3A302Z | SSR-3A402Z |
|----------------------------------|--------------------------------------|--|-------------------------------------|------------|------------|------------|
| | | High voltage | SSR-3A104Z | SSR-3A204Z | SSR-3A304Z | SSR-3A404Z |
| Appearance | |  | | | | |
| W X H X D (mm) | | 109.0×60.0×31.3 | | | | |
| Load | Usage load voltage | Low voltage | 90-264 V a.c. | | | |
| | | High voltage | 90-480 V a.c. | | | |
| | Peak voltage (Non-repeating) | Low voltage | 600 V | | | |
| | | High voltage | 800 V | 1,200 V | | |
| | Rated load current | | 10 A | 20 A | 30 A | 40 A |
| | Frequency | | 50/60 Hz (Common) | | | |
| | Input current (8.3 ms non-repeating) | Low voltage | 170 A | 260 A | 420 A | |
| | | High voltage | 170 A | 250 A | 370 A | |
| | Leakage current | | 20 mA or less | | | |
| | Output ON voltage drop | | 1.6 V (RMS) or less | | | |
| Input | Rated voltage | | 100-240 V a.c. | | | |
| | Operating voltage range | | 70-26 4V a.c. | | | |
| | Impedance | | 40 kΩ or less | | | |
| | Operating voltage | | 70 V a.c. More than | | | |
| | Current input | | Constant current method: 12 mA (±3) | | | |
| Response time | | 1/2 Cycle + 1 ms max ("R" type 1 ms or less) | | | | |
| Insulation Resistance | | 500 V d.c., 100 MΩ (between input and output and case) | | | | |
| Voltage withstand | | 3,000 V a.c. (1 minute at 60 Hz) | | | | |
| Vibration resistance | | 10-55 Hz , width of retrofit : 1.5 mm, X, Y, and Z for 2 hours each. | | | | |
| Shock resistance | | 1,000 m/s ² , 3 times in each of X, Y, and Z directions | | | | |
| Storage temperature | | -30 ~ 90 °C | | | | |
| Ambient temperature and humidity | | -5 ~ 40 °C, 45 ~ 85 % RH (without condensation) | | | | |
| Pollution degree | | Level 2 | | | | |
| Use Purpose | | resistive/inductive loads | | | | |
| Application Specification | | IEC 62314 | | | | |
| Weight (g) | | 227 | | | | |

New product Phase
General type phase
Multifunctional 3-phase Radiator integrated type
New product 3-phase
General type 3-phase
Slim type phase Radiator integrated type
Slim type 2-line cutoff Radiator integrated type
Slim type 3-phase Radiator integrated type
Heatsink, PCB board phase

Suffix code

| Model | Code | Content |
|---------------------------|---|-----------------------------------|
| SSR-3 | <input type="checkbox"/> <input type="checkbox"/> <input type="checkbox"/> <input type="checkbox"/> | 3-phase, normal contactless relay |
| Input voltage | D | 5-24 V d.c. |
| | A | 100-240 V a.c. |
| Rated load current | 10 | 10 A |
| | 20 | 20 A |
| | 30 | 30 A |
| | 40 | 40 A |
| Used load voltage | 2 | 90-264 V a.c. (Low voltage) |
| | 4 | 90-480 V a.c. (High voltage) |
| The mode of operationally | Z | Zero Cross Switching (Standard) |
| | R | Random switching |

SOLID STATE RELAYS

HSR-3 series

Specifications

- DC input-AC load (for low voltage : 90-264 V a.c.)

| Model | | Low voltage | HSR-3D102□ | HSR-3D202□ | HSR-3D302□ | HSR-3D402□ | HSR-3D502□ | HSR-3D702□ |
|----------------------------------|--------------------------------------|--|--------------------------------------|----------------|------------|------------|------------|------------|
| | | High voltage | HSR-3D104□ | HSR-3D204□ | HSR-3D304□ | HSR-3D404□ | HSR-3D504□ | HSR-3D704□ |
| Appearance | |  | | | | | | |
| WXHxD(mm) | | 109.0×74.8×34.5 | | | | | | |
| Load | Usage Load Voltage | Low voltage | 90-264 V a.c. | | | | | |
| | | High voltage | 90-480 V a.c. | | | | | |
| | Peak voltage (Non-repeating) | Low voltage | 600 V | | | | 800 V | |
| | | High voltage | 800 V | 1,200 V | | | | |
| | Rated load current | | 10 A | 20 A | 30 A | 40 A | 50 A | 70 A |
| | Frequency | | 25-65 Hz | | | | | |
| | Input current (8.3 ms non-repeating) | Low voltage | 125 A | 260 A | 315 A | | 580 A | |
| | | High voltage | 170 A | 250 A | 315 A | | 580 A | |
| | Leakage current | Low voltage | 1.5 mA | 1.8 mA or less | | | 1.5 mA | |
| | | High voltage | 20 mA or less | | | | | |
| Output ON voltage drop | Low voltage | 1.5 V | 1.8 V | | | | | |
| | High voltage | 1.95 V | 1.8 V | | | | | |
| Input | Rated voltage | | 5-24 V d.c. | | | | | |
| | Operating voltage range | | 4-32 V d.c. | | | | | |
| | Impedance | | 4 kΩ or less | | | | | |
| | Operating voltage | | 3 V d.c. More than | | | | | |
| | Current input | | Constant current method: 14 mA (± 3) | | | | | |
| Response time | | 1/2cycle + 1 ms max (less than 1 ms) | | | | | | |
| Insulation Resistance | | 500 V d.c., 100 MΩ (between input and output and case) | | | | | | |
| Withstand voltage | | 2,500 V a.c. (1 minute at 60Hz) | | | | | | |
| Vibration resistance | | 10-55 Hz, double amplitude : 1.5 mm, 2 hours in each of X, Y, and Z directions | | | | | | |
| Shock resistance | | 1,000 m/s ² , 3 times in each of X, Y, and Z directions | | | | | | |
| Storage temperature | | -30 ~ 90 °C | | | | | | |
| Ambient temperature and humidity | | -20 ~ 80 °C, 45 ~ 85% RH (without condensation) | | | | | | |
| Weight (g) | Radiator detachable type | | 400 | | | | - | |
| | Radiator integrated type | | - | | | | 2,000 | 2,600 |

● AC input-AC load

| Model | | Low voltage | HSR-3D102□ | HSR-3D202□ | HSR-3D302□ | HSR-3D402□ | HSR-3D502□ | HSR-3D702□ |
|----------------------------------|--------------------------------------|--|-------------------------|------------|------------|------------|------------|------------|
| | | High voltage | HSR-3D104□ | HSR-3D204□ | HSR-3D304□ | HSR-3D404□ | HSR-3D504□ | HSR-3D704□ |
| Appearance | |  | | | | | | |
| WXHxD(mm) | | 109.0×74.8×34.5 | | | | | | |
| Load | Usage Load Voltage | Low voltage | 100-240 V a.c. | | | | | |
| | | High voltage | 90-264 V a.c. | | | | | |
| | Peak voltage (Non-repeating) | Low voltage | 600 V | | | | 800 V | |
| | | High voltage | 800 V | 1,200 V | | | | |
| | Rated load current | | 10 A | 20 A | 30 A | 40 A | 50 A | 70 A |
| | Frequency | | 25-65 Hz | | | | | |
| | Input current (8.3 ms non-repeating) | Low voltage | 125 A | 260 A | 315 A | | 580 A | |
| | | High voltage | 170 A | 250 A | 315 A | | 580 A | |
| | Leakage current | Low voltage | 20 mA | | | | 1.5 mA | |
| | | High voltage | 20 mA or less | | | | | |
| Output ON voltage drop | Low voltage | 1.5 V | 1.8 V | | | | | |
| | High voltage | 1.95 V | 1.8 V | | | | | |
| Input | Rated voltage | | 100-240 V a.c. | | | | | |
| | Operating voltage range | | 90-264 V a.c. | | | | | |
| | Impedance | | 40 kΩ or less | | | | | |
| | Operating voltage | | 72 V a.c. More than | | | | | |
| | Current input | | 240 V a.c. / 9 mA (± 4) | | | | | |
| Response time | | 1/2 cycle + 1 ms max (less than 1 ms) | | | | | | |
| Insulation Resistance | | 500 V d.c., 100 MΩ (between input and output and case) | | | | | | |
| Withstand voltage | | 2,500 V a.c. (1 minute at 60Hz) | | | | | | |
| Vibration resistance | | 10-55 Hz, double amplitude : 1.5 mm, 2 hours in each of X, Y, and Z directions | | | | | | |
| Shock resistance | | 1,000 m/s ² , 3 times in each of X, Y, and Z directions | | | | | | |
| Storage temperature | | -30 ~ 90 °C | | | | | | |
| Ambient temperature and humidity | | -20 ~ 80 °C, 45 ~ 85% RH (without condensation) | | | | | | |
| Weight (g) | Radiator detachable type | | 400 | | | | - | |
| | Radiator integrated type | | - | | | | 2,000 | 2,600 |

New product Phase
General type phase
Multifunctional 3-phase Radiator integrated type
New product 3-phase
General type 3-phase
Slim type phase Radiator integrated type
Slim type 2-line cutoff Radiator integrated type
Slim type 3-phase Radiator integrated type
Heatsink, PCB board phase

Suffix code

| Model | Code | Content |
|-------------------------------------|-----------|--|
| HSR-3 | □ □ □ □ □ | 3-Phase solid-state relay |
| Voltage input | D | 4-32 V d.c. |
| | A | 90-264 V a.c. |
| Rated load current | 10 | 10 A |
| | 20 | 20 A |
| | 30 | 30 A |
| | 40 | 40 A |
| | 50 | 50 A |
| | 70 | 70 A |
| Load voltage | 2 | 90-264 V a.c. (Low voltage) |
| | 4 | 90-480 V a.c. (High voltage) |
| The mode of operationally | Z | Zero cross switching (standard product) |
| | R | Random switching |
| Whether or not radiator is attached | | No radiator |
| | T | Radiator integrated type (50 A, 70 A only) |

(Note) Operation method Z : Zero cross switching, R : Random switching

SOLID STATE RELAYS

HSR-SL series

Specifications

| Model | | Low voltage | HSR-SLD152Z | HSR-SLD252Z | HSR-SLD402Z |
|----------------------------------|--------------------------------------|--|------------------------------------|----------------|------------------|
| | | High voltage | HSR-SLD154Z | HSR-SLD254Z | HSR-SLD404Z |
| Appearance | |  | | | |
| WXHxD(mm) | | CE | 22.4×99.0×98.5 | | 44.4×99.0×98.5 |
| | | S-MARK | 22.4×99.0×98.5 | 44.4×99.0×98.5 | 85.0×114.0×118.0 |
| Load | Usage Load Voltage | Low voltage | 90-264 V a.c. | | |
| | | High voltage | 90-480 V a.c. | | |
| | Peak voltage (Non-repeating) | Low voltage | 600 V | | |
| | | High voltage | 800 V | 1,200 V | |
| | Rated load current | | 15 A | 25 A | 40 A |
| | Frequency | | 50/60 Hz (Common) | | |
| | Input current (8.3 ms non-repeating) | Low voltage | 170 A | 260 A | 420 A |
| | | High voltage | 170 A | 250 A | 370 A |
| | Leakage current | | 20 mA or less | | |
| | Output ON voltage drop | | 1.6 V (RMS) or less | | |
| Input | Rated voltage | | 5-24 V d.c. | | |
| | Operating voltage range | | 4-32 V d.c. | | |
| | Impedance | | 4 kΩ or less | | |
| | Operating voltage | | 3 V d.c. More than | | |
| | Return voltage | | 1.5 V d.c. or less | | |
| | Current input | | Constant current method: 8 mA (±3) | | |
| Response time | | 1/2 Cycle + 1 ms max. ("R" type 1 ms or less) | | | |
| Insulation Resistance | | 500 V d.c., 100 MΩ (between input and output and case) | | | |
| Withstand voltage | | 3,000 V a.c. (1 minute at 60 Hz) | | | |
| Vibration resistance | | 10-55 Hz, double amplitude : 1.5 mm, 2 hours in each of X, Y, and Z directions | | | |
| Shock resistance | | 1,000 m/s ² , 3 times in each of X, Y, and Z directions | | | |
| Storage temperature | | -30 ~ 90 °C | | | |
| Ambient temperature and humidity | | -5 ~ 40 °C, 45 ~ 85% RH (However, there should be no condensation) | | | |
| Pollution degree | | Level 2 | | | |
| Use Purpose | | Resistive load / inductive load | | | |
| Applied standard | | IEC 62314 | | | |
| Weight (g) | | 230 | | 372 | |

Suffix code



| Model | Code | Content |
|---------------------------|---|--|
| HSR-SL | <input type="checkbox"/> <input type="checkbox"/> <input type="checkbox"/> <input type="checkbox"/> <input type="checkbox"/> <input type="checkbox"/> | Slim type single phase solid state relay |
| Input voltage | D | 4-32 V d.c. |
| Contact | - | 1 Contact (no mark) |
| | 2C | 2 contacts (15 A only) |
| Rated load current | 15 | 15 A |
| | 25 | 25 A |
| | 40 | 40 A |
| Used load voltage | 2 | 90-264 V a.c. (Low voltage) |
| | 4 | 90-480 V a.c. (High voltage) |
| The mode of operationally | Z | Zero cross switching (standard product) |
| | R | Random switching |
| Optional | BI | Bimetal 60 °C / 80 °C mark |

※ The 2-contact type is only available for the low/high voltage type of 15 A product. (HSR-SLD2C152Z, HSR-SLD2C154Z)

HSR-2SLD/SE series



Specifications

| Model | | Low voltage | HSR-2SE252Z | HSR-2SLD252Z | HSR-2SLD402Z |
|----------------------------------|--------------------------------------|---|---|---|-------------------|
| | | High voltage | HSR-2SE254Z | HSR-2SLD254Z | HSR-2SLD404Z |
| Appearance | |   | |  | |
| WXHxD(mm) | | Low voltage | 58.0×96.6×130.0 | | 95.0×96.6×156.7 |
| | | High voltage | | | 110.0×133.0×140.1 |
| Load | Usage Load Voltage | Low voltage | 90-264 V a.c. | | |
| | | High voltage | 90-480 V a.c. | | |
| | Peak voltage (Non-repeating) | Low voltage | 600 V | | |
| | | High voltage | 1,200 V | | |
| | Rated load current | | 25 A | | 40 A |
| | Frequency | | 50/60 Hz (Common) | | |
| | Input current (8.3 ms non-repeating) | Low voltage | 260 A | | 420 A |
| | | High voltage | 250 A | | 370 A |
| Leakage current | | 10 mA or less | | | |
| Output ON voltage drop | | 1.8 V (RMS) or less | | | |
| Rated impulse withstand voltage | Low voltage | 4 kV | | | |
| | High voltage | 6 kV | | | |
| Input | Rated voltage | | 5-24 V d.c. | | |
| | Operating voltage range | | 4-32 V d.c. | | |
| | Impedance | | 4 kΩ or less | | |
| | Operating voltage | | 3 V d.c. More than | | |
| | Return voltage | | 1.5 V d.c. or less | | |
| | Current input | | Constant current method : 10 mA (±3) | | |
| Detection unit | Rated voltage | | 24 V d.c. | | |
| | Operating voltage range | | 20-26 V d.c. | | |
| | Power Consumption | | 25 mA or less, 40 mA or less in case of alarm output (based on 24 V d.c.) | | |
| | Collector internal pressure | | 30 V d.c. or less | | |
| | Current through current | | 50 mA or less | | |
| | Collector power consumption | | 500 mW | | |
| | Output form | | Transistor open collector (High when abnormality is detected) | | |
| Response time | | 1/2 Cycle + 1 ms max. ("R" type 1 ms or less) | | | |
| Insulation Resistance | | 500 V d.c., 100 MΩ (between input and output and case) | | | |
| Withstand voltage | | 2,500 V a.c. (1 minute at 60 Hz) | | | |
| Vibration resistance | | 10-55 Hz, double amplitude : 1.5 mm, 2 hours in each of X, Y, and Z directions | | | |
| Shock resistance | | 1,000 m/s ² , 3 times in each of X, Y, and Z directions | | | |
| Storage temperature | | -30 ~ 90 °C | | | |
| Ambient temperature and humidity | | -20 ~ 80 °C, 45 ~ 85 % RH (without condensation) | | | |
| Pollution degree | | Level 2 | | | |
| Protection structure | | IP20 (IEC 60529) | | | |
| Purpose of use | | Resistive load / inductive load | | | |
| Applied standard | | IEC 62314 | | | |
| Weight (g) | | 1,000 | | 1,300 | |

New product Phase
General type phase
Multifunctional 3-phase Radiator integrated type
New product 3-phase
General type 3-phase
Slim type phase Radiator integrated type
Slim type 2-line cutoff Radiator integrated type
Slim type 3-phase Radiator integrated type
Heatsink, PCB board phase

Suffix code

| Model | Code | Content |
|---------------------------|--|---|
| HSR-2SLD | <input type="checkbox"/> <input type="checkbox"/> <input type="checkbox"/> | 2-wire cut-off alarm output solid-state relay (alarm open collector output) |
| HSR-2SE | <input type="checkbox"/> <input type="checkbox"/> <input type="checkbox"/> | 2-wire insulation economical solid state relay (alarm bimetal contact output) |
| Rated load current | 25 | 25 A |
| | 40 | 40 A |
| Used load voltage | 2 | 90-264 V a.c. (Low voltage) |
| | 4 | 90-480 V a.c. (High voltage) |
| The mode of operationally | Z | Zero cross switching (standard product) |
| | R | Random switching |

SOLID STATE RELAYS

HSR-3SL series

Specification



| Model | | Low voltage | HSR-3SLD152Z | HSR-3SLD252Z | HSR-3SLD402Z |
|----------------------------------|--------------------------------------|--|--------------------------------------|--------------|-----------------|
| | | High voltage | HSR-3SLD154Z | HSR-3SLD254Z | HSR-3SLD404Z |
| Appearance | |  | | | |
| WXHxD(mm) | | 79.0×96.6×120.0 | | | 95.0×96.6×146.0 |
| Load | Usage Load Voltage | Low voltage | 90-264 V a.c. | | |
| | | High voltage | 90-480 V a.c. | | |
| | Peak voltage (Non-repeating) | Low voltage | 600 V | | |
| | | High voltage | 800 V | 1,200 V | |
| | Rated load current | | 15 A (40 °C) | 25 A (25 °C) | 40 A (25 °C) |
| | Frequency | | 50/60 Hz (Common) | | |
| | Input current (8.3 ms non-repeating) | Low voltage | 170 A | 260 A | 420 A |
| | | High voltage | 170 A | 250 A | 370 A |
| | Leakage current | | 20 mA or less | | |
| | Output ON voltage drop | | 1.6 V (RMS) or less | | |
| Input | Rated voltage | | 5-24 V d.c. | | |
| | Operating voltage range | | 4-32 V d.c. | | |
| | Impedance | | 4 kΩ or less | | |
| | Operating voltage | | 3 V d.c. More than | | |
| | Return voltage | | 1.5 V d.c. or less | | |
| | Current input | | Constant current method : 10 mA (±3) | | |
| Response time | | 1/2 Cycle + 1 ms max. ("R" type 1 ms or less) | | | |
| Insulation Resistance | | 500 V d.c., 100 MΩ (between input and output and case) | | | |
| Withstand voltage | | 3,000 V a.c. (1 minute at 60 Hz) | | | |
| Vibration resistance | | 10-55 Hz, double amplitude : 1.5 mm, 2 hours in each of X, Y, and Z directions | | | |
| Shock resistance | | 1,000 m/s ² , 3 times in each of X, Y, and Z directions | | | |
| Storage temperature | | -30 ~ 90 °C | | | |
| Ambient temperature and humidity | | -20 ~ 80 °C, 45 ~ 85 % RH (without condensation) | | | |
| Weight (g) | | 1,000 | | | 1,300 |

Suffix code

| Model | Code | Content |
|---------------------------|---|---|
| HSR-3SL | <input type="checkbox"/> <input type="checkbox"/> <input type="checkbox"/> <input type="checkbox"/> | Slim type 3-phase solid-state relay |
| Input voltage | D | 4-32 V d.c. |
| Rated load current | 15 | 15 A |
| | 25 | 25 A |
| | 40 | 40 A |
| Used load voltage | 2 | 90-264 V a.c. (Low voltage) |
| | 4 | 90-480 V a.c. (High voltage) |
| The mode of operationally | Z | Zero cross switching (standard product) |
| | R | Random switching |

HSP/HSM/HSN series

HSP series / HSM series

| Model | HSP-10 | HSP-20 | HSP-40 | HSM-70 | HSM-110 | HSM-150 | HSM-200 | HSM-250 |
|-------------|---|------------|------------|---|------------|--------------------------|--------------------------|--------------------------|
| | | HSR-2□10□□ | HSR-2□20□□ | HSR-2□30□□ HSR-2□40□□ | HSR-2□10□□ | HSR-2□20□□ HSR-2□30□□ | HSR-2□40□□ HSR-3□10□□ | HSR-3□20□□ HSR-3□30□□ |
| Appearance |  | | |  | | | | |
| Capacity | 10 A | 20 A | 30 A | 10 A | 20 A | 40 A | 20 A | 40 A |
| Length (mm) | 48 | 80 | 109 | 70 | 110 | 150 | 200 | 250 |

HSN series

| Model | HSN-80 | HSN-120 | HSN-80-F | HSN-120-F |
|---------------------|---|------------|------------|------------|
| | | HSR-2□50□□ | HSR-2□70□□ | HSR-3□50□□ |
| With or without fan | Without | Without | With | With |
| Appearance |  | | | |
| Capacity | 50 A | 70 A | 50 A | 70 A |
| Length (mm) | 80 | 120 | 92X92X25T | 92X92X25T |

HSR-PD series

Specifications

| Model | | HSR-PD032Z | HSR-PD052Z | HSR-PD082Z |
|----------------------------------|--|---|--|---|
| Appearance | |  |  |  |
| WXHxD(mm) | | 35.0×19.0×8.0 | 37.5×23.2×10.6 | 35.0×36.7×20.0 |
| Load | Rated load voltage | 100-220 V a.c. | | |
| | Used load voltage | 90-240 V a.c. | | |
| | Peak voltage (non-repeating) | 600 V | | |
| | Rated load current | 3 A | 5 A | 8 A |
| | Frequency | 50/60 Hz | | |
| | Input current | 30 A | 60 A | 120 A |
| | Leakage current | 10 mA or less | | |
| Input | Output ON voltage drop | 1.6 V (rms) or less | | |
| | Rated voltage | 5-24 V d.c. | | |
| | Operating voltage range | 4-32 V d.c. | | |
| | Impedance | 4 kΩ or less | | |
| | Operating voltage | 3 V d.c. More than | | |
| | Return voltage | 1.5 V d.c. or less | | |
| Current input | Constant current method : 10 mA (±3) | | | |
| Response time | 1/2 cycle + 1 ms max | | | |
| Insulation Resistance | 500 V d.c., 100 MΩ (between input and output and case) | | | |
| Voltage withstand | 2500 V a.c. (1 minute at 60 Hz) | | | |
| Vibration resistance | 10-55 Hz, double amplitude : 1.5 mm, 2 hours in each of X, Y, and Z directions | | | |
| Shock resistance | 100 m/s, 3 times each in X, Y, Z directions | | | |
| Storage temperature | -30 ~ 90 °C | | | |
| Ambient temperature and humidity | -20 ~ 80 °C, 45 ~ 85 % RH (without condensation) | | | |
| Weight (g) | 10 | 22 | 27 | |

Suffix code









| Model | Code | Content |
|---------------------------|---------|---|
| HSR-P | □ □ □ □ | Single-phase solid-state relay for printed circuit boards |
| Input voltage | D | 4-32 V d.c. |
| Rated load current | 03 | 3 A |
| | 05 | 5 A |
| | 08 | 8 A |
| Used load voltage | 2 | 90-240 V a.c. (Low voltage) |
| The mode of operationally | Z | Zero cross switching |
| | R | Random switching |

New product Phase
General type phase
Multifunctional 3-phase Radiator integrated type
New product 3-phase
General type 3-phase
Slim type phase Radiator integrated type
Slim type 2-line cutoff Radiator integrated type
Slim type 3-phase Radiator integrated type
Heatsink, PCB board phase

POWER SUPPLIES

TPS series

Specifications









| Model | TPS-15S | TPS-30S | TPS-50S | TPS-75S | TPS-100S |
|---------------------------|--|---|--|---|---|
| Appearance |  |  |  |  |  |
| W×H×D (mm) | 64.1×97.6×32.0 | 79.0×98.0×37.0 | 83.0×125.0×38.8 | 96.0×135.0×40.2 | 93.0×199.0×50.0 |
| Power output | 15 W | 30 W | 50 W | 75 W | 100 W |
| Input voltage | Free voltage 100-240 V a.c. (50/60 Hz) | | | | Manual-select input 100-120 V a.c. 50/60 Hz/ 200-240 V a.c. 50/60 Hz |
| Output voltage | 5 V, 12 V, 15 V, 24 V d.c. | | | 5 V, 12 V, 15 V, 24 V d.c. | |
| Voltage fluctuation range | ±5 ~ ±10 % (Varies due to the internal VR) | | | | |
| Protective circuit | ● Overcurrent, ● Overvoltage, ● Overheating, ● Output short-circuit protection | | | | |
| Dielectric strength | ● 2,700 V a.c. 1 minute, detection current = 10 mA, (input-output) ● 1,500 V a.c. 1 minute, detection current = 10 mA, (input-FG) ● 500 V a.c. 1 minute, detection current = 10 mA, (output-FG) | | | | |
| Insulation resistance | 100 MΩ min, 500Vd.c. (Input - Output) | | | | |
| Model | TPS-150S | TPS-220S | TPS-350S | TPS-450S | |
| Appearance |  |  |  |  | |
| W×H×D (mm) | 93.0×209.0×65.0 | 93.0×209.0×65.0 | 115.0×230.0×50.0 | 115.0×230.0×50.0 | |
| Power output | 150 W | 220 W | 350 W | 450 W | |
| Input voltage | Manual-select input 100-120 V a.c. 50/60 Hz / 200-240 V a.c. 50/60 Hz | | | Free voltage 100-240 V a.c. 50/60 Hz | |
| Output voltage | 5 V, 12 V, 15 V, 24 V d.c. | 12 V, 15 V, 24 V d.c. | 12 V, 24 V, 48 V d.c. | | |
| Voltage fluctuation range | ±5 ~ ±10 % (Depends on internal VR) | | | | |
| Protective circuit | ● Overcurrent, ● Overvoltage, ● Overheating, ● Output short-circuit protection | | | | |
| Dielectric strength | ● 2,700 V a.c. 1 minute, detection current = 10 mA, (input-output) ● 1,500 V a.c. 1 minute, detection current = 10 mA, (input-FG) ● 500 V a.c. 1 minute, detection current = 10 mA, (output-FG) | | | | |
| Insulation resistance | 100 MΩ min, 500 V d.c. (Input-output) | | | | |

Suffix code

| Model | Code | Content |
|-------------------------------|--|---|
| TPS- | <input type="checkbox"/> <input type="checkbox"/> - <input type="checkbox"/> | Enclosed Type |
| Power output | 15 | 15 W |
| | 30 | 30 W |
| | 50 | 50 W |
| | 75 | 75 W |
| | 100 | 100 W |
| | 150 | 150 W |
| | 220 | 220 W |
| | 350 | 350 W |
| 450 | 450 W | |
| Number of output voltage | S | 1 Output |
| Output voltage classification | 05 | 5 V d.c. (220 W, 350 W, 450 W Exclude) |
| | 12 | 12 V d.c. |
| | 15 | 15 V d.c. (350 W, 450 W Exclude) |
| | 24 | 24 V d.c. |
| | 48 | 48 V d.c. (15 W, 30 W, 50 W, 75 W, 100 W, 150 W, 220 W Exclude) |

DPS series

Specifications

| Model | DPS-15S | DPS-30S | DPS-50S | DPS-75S |
|---------------------------|---|--|--|--|
| Appearance |  |  |  |  |
| W×H×D (mm) | 25.0×90.0×103.0 | 40.0×90.0×103.0 | 40.0×90.0×103.0 | 56.0×124.0×97.8 |
| Power output | 15 W | 30 W | 50 W | 75 W |
| Input voltage | 100-240 V a.c. (Free power) | | | |
| Output voltage | 5 V, 12 V, 15 V, 24 V d.c. | | | 12 V, 24 V, 48 V d.c. |
| Voltage fluctuation range | ±5 ~ 10 % (Varies due to the internal VR) | | | |
| Protective circuit | ● Overcurrent, ● Overvoltage, overheat, ● Output short-circuit protection, ● DC OK display function | | | |
| Dielectric strength | ● 2,700 V a.c. 1 minute, detection current = 10 mA, (input-output) ● 500 V a.c. 1 minute, detection current = 10 mA, (output-FG) | | ● 1,500 V a.c. 1 minute, detection current = 10 mA, (input-FG) ● 500 V a.c. 1 minute, detection current = 10 mA, (output-DC OK) | |
| Insulation resistance | 50 MΩ or more. (Input-Output, FG), (Output-FG, DC OK) | | | |
| Model | DPS-100S | DPS-120S | DPS-180S | DPS-240S |
| Appearance |  |  |  |  |
| W×H×D (mm) | 56.0×124.0×97.8 | 66.0×124.0×97.8 | 66.0×124.0×97.8 | 125.5×124.0×97.8 |
| Power output | 100 W | 120 W | 180 W | 240 W (※ However, DPS-240S-12 is 216W) |
| Input voltage | 100-240 V a.c. 50/60 Hz (Free power) | 100-120 V a.c. 50/60 Hz/ 200-240 V a.c. 50/60 Hz(Automatic input selection) | | |
| Output voltage | 12 V, 24 V, 48 V d.c. | | 24 V, 48 V d.c. | 12 V, 24 V, 48 V d.c. |
| Voltage fluctuation range | ±5 ~ 10 % (Depends on internal VR) | | | |
| Protective circuit | ● Overcurrent, ● Overvoltage, Overheat, ● Output short-circuit protection, ● DC OK display, ● DC OK output function | | | |
| Dielectric strength | ● 2,700 V a.c. 1 minute, detection current = 10 mA, (input-output) ● 500 V a.c. 1 minute, detection current = 10 mA, (output-FG) | | ● 1,500 V a.c. 1 minute, detection current = 10 mA, (input-FG) ● 500 V a.c. 1 minute, detection current = 10 mA, (output-DC OK) | |
| Insulation resistance | 50MΩ or more (input-output, FG), (output-FG, DC OK) | | | |



Enclosed type
DIN rail type
Small type DIN rail type

Suffix code

| Model | Code | Content |
|-------------------------------|--|--|
| DPS- | <input type="checkbox"/> <input type="checkbox"/> <input type="checkbox"/> | DPS Power Supply (DIN Rail Type) |
| Power output | 15 | 15 W |
| | 30 | 30 W |
| | 50 | 50 W |
| | 75 | 75 W |
| | 100 | 100 W |
| | 120 | 120 W |
| | 180 | 180 W |
| | 240 | 240 W (※ only DPS-240S-12 : 216 W) |
| Number of output voltage | S | 1 Output (single output) |
| Output voltage classification | 05 | 5 V d.c. (DPS-75S, DPS-100S, DPS-120S, DPS-180S, DPS-240S excluded) |
| | 12 | 12 V d.c. (DPS-180S excluded) |
| | 15 | 15 V d.c. (DPS-75S, DPS-100S, DPS-120S, DPS-180S, DPS-240S excluded) |
| | 24 | 24 V d.c. |
| | 48 | 48 V d.c. (DPS-15S, DPS-30S, DPS-50S excluded) |

HNPS series

Specifications

| Model | HNPS-03S | HNPS-07S |
|---------------------------|--|---|
| Appearance |  |  |
| W×H×D (mm) | 36.0×80.0×65.0 | |
| Power output | 3 W | 7.5W |
| Input voltage | 100-240 V a.c. 50/60 Hz ±10% of power supply voltage | |
| Output voltage | 5 V, 12 V, 15 V, 24 V | |
| Voltage fluctuation range | ±5 ~ 10 % (varies due to the internal VR) | |
| Protective circuit | Over voltage, Over current, Over heat, Short circuit | |
| Dielectric strength | <ul style="list-style-type: none"> ● 3 kVAC (between input and output), 1.5 kVAC (between input and FG), ● 500 V a.c. (Between output and FG), (detection current: 10 mA, for 1 min) | |
| Insulation Resistance | 100 MΩ or more (between input and output, at 500 V d.c.) | |
| Weight (g) | 120 | |

Suffix code

| Model | Code | Content |
|-------------------------------|---|----------------------------------|
| HNPS- | <input type="checkbox"/> <input type="checkbox"/> <input type="checkbox"/> <input type="checkbox"/> | DPS Power Supply (DIN Rail Type) |
| Power output | 03 | 3 W |
| | 07 | 7.5 W |
| Number of output voltage | S | 1 Output (Single output) |
| Output voltage classification | 05 | 5 V d.c. |
| | 12 | 12 V d.c. |
| | 15 | 15 V d.c. |
| | 24 | 24 V d.c. |
| Structure | D | Rail structure (DIN) |

DR series



Product composition

| Model | Push button switch | | | | | |
|---------------|-------------------------------|----------------|--------------------|----------------|--------------------|-----------------|
| | Chrome plated guard type | | Plastic guard type | | Plastic guard type | |
| | Flat Ø22 | Protrusion Ø16 | Flat Ø22 | Protrusion Ø16 | Square Ø16 | Rectangular Ø16 |
| Appearance | | | | | | |
| Actuator code | DRF-A | DRF-R | DRF-K | DRF-T | DRF-S | MRF-O |
| Model | Illuminated pushbutton switch | | | | | |
| | Chrome plated guard type | | Plastic guard type | | Plastic guard type | |
| | Flat Ø22 | Protrusion Ø16 | Flat Ø22 | Protrusion Ø16 | Square Ø16 | Rectangular Ø16 |
| Appearance | | | | | | |
| Actuator code | DRX-A | DRX-R | DRX-K | DRX-T | DRX-S | MRX-O |
| Model | Indicator light | | | | | |
| | Chrome plated guard type | | Plastic guard type | | Plastic guard type | |
| | Flat Ø22 | Protrusion Ø16 | Flat Ø22 | Protrusion Ø16 | Square Ø16 | Rectangular Ø16 |
| Appearance | | | | | | |
| Actuator code | DRP-A | DRP-R | DRP-K | DRP-T | DRP-S | MRP-O |
| Model | Selector switch | | | | | |
| | Chrome plated guard type | | Plastic guard type | | Plastic guard type | |
| | Flat Ø22 | Protrusion Ø16 | Flat Ø22 | Protrusion Ø16 | Square Ø16 | Rectangular Ø16 |
| Appearance | | | | | | |
| Actuator code | DRS-A | DRS-R | DRS-K | DRS-T | DRS-S | MRS-O |
| Model | Illuminated selector switch | | | | | |
| | Chrome plated guard type | | Plastic guard type | | Plastic guard type | |
| | Flat Ø22 | Protrusion Ø16 | Flat Ø22 | Protrusion Ø16 | Square Ø16 | Rectangular Ø16 |
| Appearance | | | | | | |
| Actuator code | DRT-A | DRT-R | DRT-K | DRT-T | DRT-S | MRT-O |
| Model | KEY selector switch | | | | | |
| | Chrome plated guard type | | Plastic guard type | | Plastic guard type | |
| | Flat Ø22 | Protrusion Ø16 | Flat Ø22 | Protrusion Ø16 | Square Ø16 | Rectangular Ø16 |
| Appearance | | | | | | |
| Actuator code | DRK-A | DRK-R | DRK-K | DRK-T | DRK-S | MRK-O |

New product
Control switch

High-end
Control switch

New product
assembly
Indicator light
Rectangular
indicator light

Power switch
Main switch

Cam switch

























Limit
switch

Micro
switch





Foot switch
Mono lever
switch

Hoist
switch

CONTROL SWITCHES

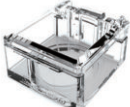
| Model | Emergency stop switch | | | |
|---------------|---|---|--|---|
| | Chrome plated guard type | | Plastic guard type | |
| | Flat Ø22 | Protrusion Ø16 | Flat Ø22 | Protrusion Ø16 |
| Appearance |  |  |  |  |
| Actuator code | DRE-AM | DRE-RM | DRE-KM | DRE-TM |
| Appearance |  |  |  |  |
| Actuator code | DRE-AA | DRE-RA | DRE-KA | DRE-TA |
| Appearance |  |  |  |  |
| Actuator code | DRE-AR | DRE-RR | DRE-KR | DRE-TR |
| Model | Illuminated emergency stop switch | | | |
| | Chrome plated guard type | | Plastic guard type | |
| | Flat Ø22 | Protrusion Ø16 | Flat Ø22 | Protrusion Ø16 |
| Appearance |  |  |  |  |
| Actuator code | DRA-AM | DRA-RM | DRA-KM | DRA-TM |
| Appearance |  |  |  |  |
| Actuator code | DRA-AA | DRA-RA | DRA-KA | DRA-TA |
| Appearance |  |  |  |  |
| Actuator code | DRA-AR | DRA-RR | DRA-KR | DRA-TR |

Accessories

| Model | Emergency protection cover | Front protective cover | | | Anti-rotation ring |
|-------------------|---|---|---|---|---|
| | HEG-16 (Protrusion) | HSC-16P (Protrusion) | HSC-16PS (Protruding square) | HSC-22F (Flat) | DR Ø16 Anti-rotation ring |
| Application Model | DRE-R, DRE-T, DRA-R, DRA-T | DRF-R, DRF-T, DRX-R, DRX-T | DRF-S, DRF-O, DRX-S, DRX-O | DRF-A, DRS-K, DRX-A, DRX-K | Ø16 Common |
| Appearance |  |  |  |  |  |

Suffix Code

| Model | Code | Content |
|--------------------|------|-----------------------------------|
| DRF - | □ | Push button switch |
| DRX - | □ | Illuminated pushbutton switch |
| DRP - | □ | Indicator light |
| DRS - | □ | Selector switch |
| DRT - | □ | Illuminated selector switch |
| DRK - | □ | Key selector switch |
| DRE - | □ | Emergency stop switch |
| DRA - | □ | Illuminated emergency stop switch |
| Control part shape | A | Ø22 Flat |
| | R | Ø16 Protrusion |
| | K | Ø22 Flat |
| | T | Ø16 Protrusion |
| | S | Ø16 Square |
| | O | Ø16 Rectangular |
| | | Chrome plated guard |
| | | Plastic guard |

Specification

| | | |
|-------------------------------|---|-----------------------------------|
| Rating | 250 V a.c. 3 A | |
| Insulation Resistance | 100MΩ or more | |
| Withstand voltage | 1500 V a.c. 1 minute at 50/60 Hz | |
| Contact contact resistance | 50 MΩ or less | |
| Vibration resistance | 10-55 Hz double amplitude 3 mm | |
| Shock resistance | Approx. 50 G (500 $\frac{m}{s^2}$) | |
| Ambient temperature | -10 ~ 50 °C | |
| Ambient humidity | 45 ~ 85 % RH | |
| Opening and closing frequency | Up to 30 times/min | |
| life | Electrical | 200,000 times or more / 1,800 h |
| | Mechanical | 1 million times or more / 1,800 h |
| Certification |  | |

CR series



Product composition

| Model | Push button switch | | | | | |
|---------------|---|---|--|---|---|---|
| | Flat Ø30 | Flat Ø25 | Protrusion Ø30 | Protrusion Ø25 | | |
| Appearance |  |  |  |  | | |
| Actuator code | CRF-F30 | CRF-F25 | CRF-P30 | CRF-P25 | | |
| Model | Illuminated pushbutton switch | | | | | |
| | Flat Ø30 | Protrusion Ø30 | Protective guard Ø30 | Flat Ø25 | Protrusion Ø25 | Protective guard Ø25 |
| Appearance |  |  |  |  |  |  |
| Actuator code | CRX-F30 | CRX-P30 | CRX-G30 | CRX-F25 | CRX-P25 | CRX-G25 |
| Model | Indicator light | | | | | |
| | Flat Ø30 | Flat Ø25 | | | | |
| Appearance |  |  | | | | |
| Actuator code | CRP-30 | CRP-25 | | | | |
| Model | Selector switch | | | | | |
| | Short lever | | Long lever | | | |
| | Flat Ø30 | Flat Ø25 | Flat Ø30 | Flat Ø25 | | |
| Appearance |  |  |  |  | | |
| Actuator code | CRS-30 | CRS-25 | CRSL-30 | CRSL-25 | | |
| Model | Illuminated selector switch | | | | | |
| | Flat Ø30 | Flat Ø25 | Flat Ø30 | Flat Ø25 | | |
| 외형 |  |  |  |  | | |
| Actuator code | CRT-30 | CRT-25 | CRTL-30 | CRTL-25 | | |
| Model | KEY selector switch | | | | | |
| | Flat Ø30 | Flat Ø25 | | | | |
| Appearance |  |  | | | | |
| Actuator code | CRK-30 | CRK-25 | | | | |

New product
Control switch

High-end
Control switch

New product
assembly
Indicator light
Rectangular
indicator light

Power switch
Main switch

Cam switch

Limit
switch

Micro
switch









Foot switch
Mono lever
switch

Hoist
switch

CONTROL SWITCHES

| Model | Emergency stop switch | |
|---------------|---|---|
| | Flat Ø30 | Flat Ø25 |
| Appearance |  |  |
| Actuator code | CRE-30M | CRE-25M |
| Appearance |  |  |
| Actuator code | CRE-30R | CRE-25R |
| Model | Illuminated emergency stop switch | |
| | Flat Ø30 | Flat Ø25 |
| Appearance |  |  |
| Actuator code | CRA-30M | CRA-25M |
| Appearance |  |  |
| Actuator code | CRA-30R | CRA-25R |
| Model | Buzzer | |
| | Flat Ø30 | Flat Ø25 |
| Appearance |  |  |
| Actuator code | CRB-30 | CRB-25 |

Accessories

| Model | Emergency protection cover | | Front protective cover | | Silicone cover | | Tightening tool | | |
|-------------------|---|---|---|---|---|--|---|---|---|
| | HEG-25 (Protrusion) | HEG-30 (Protrusion) | HSC-25P (Protrusion) | HSC-30P (Protrusion) | CR-25WPC | CR-30WPC | FIX HEAD-CR25 | FIX HEAD-CR30 | FIX HANDLE |
| Application Model | CRE-25, CRA-25 | CRE-30, CRA-30 | CRF-F25, CRX-F25 | CRF-F30, CRX-F30 | Ø25 | Ø30 | Ø25 | Ø30 | Handle |
| Appearance |  |  |  |  |  |  |  |  |  |





























Suffix Code

| Model | Code | Content |
|--------------------|------|-----------------------------------|
| CRF - | □ | Push button switch |
| CRX - | □ | Illuminated pushbutton switch |
| CRP - | □ | Indicator light |
| CRS - | □ | Selector short lever switch |
| CRSL - | □ | Selector long lever switch |
| CRT - | □ | Illuminated selector switch |
| CRTL - | □ | Illuminated long lever switch |
| CRK - | □ | Key selector switch |
| CRE - | □ | Emergency stop switch |
| CRA - | □ | Illuminated emergency stop switch |
| CRB- | □ | Buzzer |
| Control part shape | F30 | Ø30 Flat |
| | P30 | Ø30 Protrusion |
| | G30 | Ø30 Protective guard |
| | F25 | Ø25 Flat |
| | P25 | Ø25 Protrusion |
| | G25 | Ø25 Protective guard |

Specification

| | | |
|-----------------------------------|---|--------------------------------------|
| Contact configuration | 1a1b | |
| Contact operation | Slow-make | |
| Installation panel thickness | 1 ~ 6 mm (excluding accessories) | |
| Rated voltage / power consumption | 100-240 V a.c. / 4.4 VA or less | |
| | 380 V a.c. / 2.7 VA or less | |
| Allowable operating frequency | Mechanical | 30 times/min or less |
| | Electrical | 30 times/min or less |
| Insulation Resistance | 100MΩ or more | |
| Withstand voltage | 1500 V a.c. 50/60 Hz 1 minute | |
| Vibration resistance | Mechanical | 10-55 Hz double amplitude width 3 mm |
| | Malfunction | 10-55 Hz double amplitude width 3 mm |
| Shock resistance | Mechanical | 500 m/s ² or more |
| | Malfunction | 100 m/s ² or more |
| life | Mechanical | 10,000 times or more |
| | Electrical | 100,000 times or more |
| Ambient temperature and humidity | -25 ~ 40 °C, 45 ~ 85 % RH | |
| Storage temperature | -40 ~ 60°C | |
| Certification |  | |

MR series

| Model | Push button switch | | | | | |
|---------------|---|--|---|---|---|---|
| | Aluminum guard | | | Plastic guard | | |
| | Flat Ø30 | Flat Ø25 | Protrusion Ø22 | Flat Ø25 | Protrusion Ø22 | |
| Appearance |  |  |  |  |  | |
| Actuator code | MRF-A(Ø30) | MRF-N(Ø25) | MRF-R(Ø22) | MRF-K(Ø25) | MRF-T(Ø22) | |
| Model | Illuminated pushbutton switch | | | | | |
| | Aluminum guard | | | Plastic guard | | |
| | Flat Ø30 | Flat Ø25 | Protrusion Ø22 | Flat Ø25 | Protrusion Ø22 | ON / OFF |
| Appearance |  |  |  |  |  |  |
| Actuator code | MRX-A(Ø30) | MRX-N(Ø25) | MRX-R(Ø22) | MRX-K(Ø25) | MRX-T(Ø22) | MRX-WM2 |
| Model | Indicator light | | | | | |
| | Aluminum guard | | | Plastic guard | | |
| | Flat Ø30 | Flat Ø25 | Protrusion Ø22 | Flat Ø25 | Protrusion Ø22 | |
| Appearance |  |  |  |  |  | |
| Actuator code | MRP-A(Ø30) | MRP-N(Ø25) | MRP-R(Ø22) | MRP-K(Ø25) | MRP-T(Ø22) | |
| Model | Selector switch | | | | | |
| | Aluminum guard | | | Plastic guard | | |
| | Flat Ø30 | Flat Ø25 | Protrusion Ø22 | Flat Ø25 | Protrusion Ø22 | |
| Appearance |  |  |  |  |  | |
| Actuator code | MRS-A(Ø30) | MRS-N(Ø25) | MRS-R(Ø22) | MRS-K(Ø25) | MRS-T(Ø22) | |
| Model | Illuminated selector switch | | | | | |
| | Aluminum guard | | | Plastic guard | | |
| | Flat Ø30 | Flat Ø25 | Protrusion Ø22 | Flat Ø25 | Protrusion Ø22 | |
| Appearance |  |  |  |  |  | |
| Actuator code | MRT-A(Ø30) | MRT-N(Ø25) | MRT-R(Ø22) | MRT-K(Ø25) | MRT-T(Ø22) | |
| Appearance |  |  |  |  |  | |
| Actuator code | MRT-A3(Ø30) | MRT-N3(Ø25) | MRT-R3(Ø22) | MRT-K3(Ø25) | MRT-T3(Ø22) | |
| Model | Key selector switch | | | | | |
| | Aluminum guard | | | | | |
| | Flat Ø30 | Flat Ø25 | Protrusion Ø22 | | | |
| Appearance |  |  |  | | | |
| Actuator code | MRK-A(Ø30) | MRK-N(Ø25) | MRK-R(Ø22) | | | |

New product
Control switch

High-end
Control switch

New product
assembly
Indicator light
Rectangular
indicator light

Power switch
Main switch

Cam switch

Limit
switch

Micro
switch

Foot switch
Mono lever
switch

Hoist
switch

CONTROL SWITCHES

| Model | Emergency stop switch | | | | |
|---------------|-----------------------------------|-------------|----------------|---------------|----------------|
| | Aluminum guard | | | Plastic guard | |
| | Flat Ø30 | Flat Ø25 | Protrusion Ø22 | Flat Ø25 | Protrusion Ø22 |
| Appearance | | | | | |
| Actuator code | MRE-AM(Ø30) | MRE-NM(Ø25) | MRE-RM(Ø22) | MRE-KM(Ø25) | MRE-TM(Ø22) |
| Appearance | | | | | |
| Actuator code | MRE-AR(Ø30) | MRE-NR(Ø25) | MRE-RR(Ø22) | MRE-KR(Ø25) | MRE-TR(Ø22) |
| Model | Illuminated emergency stop switch | | | | |
| | Aluminum guard | | | Plastic guard | |
| | Flat Ø30 | Flat Ø25 | Protrusion Ø22 | Flat Ø25 | Protrusion Ø22 |
| Appearance | | | | | |
| Actuator code | MRA-AM(Ø30) | MRA-NM(Ø25) | MRA-RM(Ø22) | MRA-KM(Ø25) | MRA-TM(Ø22) |
| Appearance | | | | | |
| Actuator code | MRA-AR(Ø30) | MRA-NR(Ø25) | MRA-RR(Ø22) | MRA-KR(Ø25) | MRA-TR(Ø22) |
| Model | Buzzer | | | | |
| | Aluminum guard | | | Plastic guard | |
| | Flat Ø30 | Flat Ø25 | Protrusion Ø22 | Flat Ø25 | Protrusion Ø22 |
| Appearance | | | | | |
| Actuator code | MRB-A(Ø30) | MRB-N(Ø25) | MRB-R(Ø22) | MRB-K(Ø25) | MRB-T(Ø22) |

Accessories

| Model | Emergency sign nameplate | | Emergency protection cover | | | Front protective cover | | | Tightening tool | |
|-------------------|--------------------------|------------------------------|-------------------------------|-------------------------------|----------------|-------------------------------|-------------------------------|----------------|-----------------|------------|
| | EN-36 | EN-26 | HEG-22 (Protrusion) | HEG-25F (Flat) | HEG-30F (Flat) | HSC-22P (Protrusion) | HSC-25F (Flat) | HSC-30F (Flat) | FIX HEAD-MR | FIX HANDLE |
| Application Model | MRE-A MRA-A | MRE-R, MRE-T MRA-R, MRA-T | MRE-R, MRE-T, MRA-R, MRA-T | MRE-N, MRE-K, MRA-N, MRA-K | MRE-A, MRA-A | MRF-R, MRF-T, MRX-R, MRX-T | MRF-N, MRF-K, MRX-N, MRX-K | MRF-A, MRX-A | Ø22, Ø25, Ø30 | Handle |
| Appearance | | | | | | | | | | |

Suffix Code

| Model | Code | Content |
|--------------------|------|-----------------------------------|
| MRF - | □ | Push button switch |
| MRX - | □ | Illuminated pushbutton switch |
| MRP - | □ | Indicator light |
| MRS - | □ | Selector switch |
| MRT - | □ | Illuminated selector switch |
| MRK - | □ | Key selector switch |
| MRE - | □ | Emergency stop switch |
| MRA - | □ | Illuminated emergency stop switch |
| MRB- | □ | Buzzer |
| Control part shape | A | Ø30 flat |
| | N | Ø25 flat |
| | R | Ø22 protrusion |
| | K | Ø25 flat |
| | T | Ø22 protrusion |
| | | Aluminum guard |
| | | Plastic guard |

Specification

| | | | |
|------------------------------|----------------------------------|---|--|
| Contact unit | MR-CB | | |
| Contact configuration | 1a1b | | |
| Contact operation | Snap-action | | |
| Installation panel thickness | 7.0 mm (excluding accessories) | | |
| Mechanical | Tightening torque | Mounting nut : 1.96 N·m max, Terminal bolt : 0.78 N·m max | |
| | Operating distance | 5 mm ±0.2 | |
| | Recoil time | 3 ms or less | |
| | Operating part operation life | Button : more than 500,000 times, Selector : more than 200,000 times | |
| Electrical | Withstand voltage | 2,000 V a.c. 50/60 Hz 1 minute | |
| | Contact contact resistance | 50 mΩ or less (at the time of shipment) | |
| | Insulation Resistance | 100 MΩ or more 500 V d.c. | |
| | Rated current | 6 A 250 V a.c. | |
| | Minimum load current | 5 mA 24 V d.c., 10 mA 11 V d.c. | |
| Light source | Power supply voltage | Electrical life | More than 200,000 times |
| | | | 100-240 V a.c. (LED capacitor voltage drop type) 380 V a.c. (LED capacitor voltage drop type) 12-24 V a.c. 50/60Hz or 12-24 V d.c. (LED capacitor voltage drop type) |
| Environmental conditions | Ambient temperature and humidity | -20 ~ 55 °C, 35 ~ 85 % RH (Without condention) | |
| | Storage temperature | -40 ~ 85 °C | |
| | Shock resistance | 300 pulse period 11 ms | |
| | Vibration resistance | 100, 10 Hz-55 Hz, amplitude 0.75 mm (within 1 ms) | |

AR series



Product composition

| Model | Push button switch | | Illuminated pushbutton switch | | Indicator light | |
|---------------|--------------------|-----------------------------|-------------------------------|-----------------------|-----------------|--------|
| | Columnar | Columnar | Columnar | ON / OFF | AC | DC |
| Appearance | | | | | | |
| Actuator code | ARF-F,B,P,G,H | ARF-S | ARX-P,G,H | ARX-S | ARP-A0 | ARP-D0 |
| Model | Selector switch | Illuminated selector switch | Key selector switch | Emergency stop switch | | |
| | Lever | Lever | | | | |
| Appearance | | | | | | |
| Actuator code | ARS-S,L | ART-2,2R,3 | ARK-2,2R,3,3L,3R,3LR | ARE-3,4 | ARE-4XR | |

New product
Control switch

High-end
Control switch

New product
assembly
Indicator light
Rectangular
indicator light

Power switch
Main switch

Cam switch

Limit
switch

Micro
switch

Foot switch
Mono lever
switch

Hoist
switch

Suffix code

| Model | Code | Content |
|-------|--------------------------|-----------------------------------|
| ARF - | <input type="checkbox"/> | Push button switch |
| ARX - | <input type="checkbox"/> | Illuminated pushbutton switch |
| ARP - | <input type="checkbox"/> | Indicator light |
| ARS - | <input type="checkbox"/> | Selector switch |
| ART - | <input type="checkbox"/> | Illuminated selector switch |
| ARK - | <input type="checkbox"/> | Key selector switch |
| ARE - | <input type="checkbox"/> | Emergency stop switch |
| ARE - | <input type="checkbox"/> | Illuminated emergency stop switch |
| ARB- | <input type="checkbox"/> | Buzzer |

Specification

| | | |
|--------------------------------|----------------------|---|
| Allowable operating frequency | Mechanical | 30 times/minute |
| | Electrical | 30 times/minute |
| Insulation Resistance | | 100 MΩ or more |
| Withstand voltage | | 2,000 V a.c. 1 minute (between the same pole terminals) |
| Vibration resistance | Malfunction | 10-55 Hz double amplitude 3 mm (within 1 ms) |
| Shock resistance | Mechanical | 500 m/s ² or more |
| | Malfunction | 100 m/s ² or more |
| Life | Mechanical | 100 times or more |
| | Electrical | 10 times or more |
| Light source | Power supply voltage | 100-240 V a.c. (LED capacitor voltage drop expression) |
| | | 12-24 V a.c./d.c. (LED capacitor voltage drop expression) |
| Ambient temperature & humidity | | -25 ~ 40 °C, 45 ~ 85 % RH (Without condention) |
| Storage temperature | | -40 ~ 70°C |

Accessories

| Model | Emergency sign nameplate | Emergency Protection Cover | Tightening tool | |
|---------------|--------------------------|----------------------------|-----------------|------------|
| | EN-26 | HEG-22(Extended) | FIX HEAD-AR | FIX HANDLE |
| Applied model | ARE | ARE | All models | Handle |
| Appearance | | | | |

COMBINATION DISPLAY LIGHT

CDN series

NEW

Specification

| Model | CDN | | |
|----------------------------------|--|------------|------------|
| Appearance |  | | |
| Power Voltage | 24 V a.c. 50/60 Hz or 24 V d.c. | 110 V a.c. | 220 V a.c. |
| LED Indication Color | Red, green, yellow, white, orange, blue | | |
| Insulation resistance | 100 MΩ or more | | |
| Voltage withstand | 2,000 V a.c. 1 minute | | |
| Power consumption | 20 mA 0.4 VA | 0.4 W | 0.5 W |
| LED Rated Voltage | 24 V d.c. | | |
| Life | 50,000 hours (24 V d.c., 25 °C) | | |
| Ambient temperature and humidity | -20 °C ~ 40 °C, 45 ~ 85 % RH (Without condention) | | |
| Storage temperature | -25 ~ 55 °C | | |

(Note) CDN-S□ (30 X 30 mm) / CDN-R□ (30 X 40 mm)

Suffix code

| Model | Code | Content |
|--------------------------------------|--------------------|--|
| CDN- | □ □ -□□ □□ -□□□□□□ | Set Indicator |
| Basic model name | S | Square (30×30 mm) |
| | R | Rectangle(30×40 mm) |
| Power Voltage | D2 | 24 V a.c. 50/60 Hz or 24 V d.c. |
| | A1 | 110 V a.c. |
| | A2 | 220 V a.c. |
| Collective Face Configuration Group | 01 | 1st to 10th |
| Collective Face Configuration Column | 01 | Rows 1 to 20 |
| Lamp color | C | C : COLOR color combination R (Red), G (Green), Y (Yellow), O (Orange), A (Blue), W (White) |

CR40 series

Specifications





| Model | CR40 | | |
|---------------------------|--|----------------|-------------------|
| Appearance |  | | |
| Power Voltage | 100-240 V a.c. | 380 V a.c. | 12-24 V a.c./d.c. |
| Power consumption/current | 4.4 VA or less | 2.7 VA or less | 18 mA or less |
| Display color | Red, green, yellow, blue, white | | |
| Light source life | 100,000 h | | |

Suffix code

| Model | Code | Content |
|---------------|------|--|
| CR40 | □ □ | LED light source rectangular indicator |
| Power Voltage | A0 | 100-240 V a.c. |
| | A3 | 380 V a.c. |
| | D0 | 12-24 V a.c./d.c. |
| Display color | R | Red, green, yellow, blue, white |
| | | LED (Condenser voltage drop type) |
| | | LED (Resistance voltage drop type) |

HY-500 series

Product composition

| Model | Rated capacity | Use |
|---|---|-----|
|  Exposed HY-510 3P 250 V a.c. 15A Electromotor 3 phase power supply ON, OFF | | |
|  Recessed HY-512, HY-512S (Switch part for the lamp) HY-513, HY-513S (Switch part for the lamp) HY-514 3P 250 V a.c. 15A Electromotor for 3 phase power supply ON, OFF Electromotor for 3 phase power supply ON, OFF | 2P 250 V a.c. 15A 1 Phase Electromotor ON, OFF | |
| | 3P 250 V a.c. 15A Electromotor for 3 phase power supply ON, OFF | |
| | 3P 250 V a.c. 15A Electromotor for 3 phase power supply ON, OFF | |
|  Exposed HY-516 3P 250 V a.c. 15A Electromotor for 3 phase power supply Direct/reverse revolution for stop 1 phase, 3 phase, right/left for revolution | | |
|  Exposed HY-517 3P 250 V a.c. 15A Electromotor 1 phase, 3 phase ON, OFF | | |



| |
|--|
| New product Control switch |
| High-end Control switch |
| New product assembly Indicator light Rectangular indicator light |
| Power switch Main switch |
| Cam switch |
| Limit switch |
| Micro switch |
| Foot switch Mono lever switch |
| Hoist switch |

BE series

● Steel case (BE)

| Model | Rated capacity | Contact terminal | Marker | Case material |
|--|----------------|------------------|--------|---------------|
|  Steel case exposed BE 230 3P 440 V a.c. 30A M5 ON (Black) OFF (Red) Cold workable steel plate | | | | |

● Waterproof type (BEW, BEWT)

| Model | Rated capacity | Contact terminal | Marker | Case material |
|---|-------------------|------------------|-------------------------|------------------------------|
|  Waterproof BEW 215 BEW 230 3P 440 V a.c. 15A 3P 440 V a.c. 30A M4 M5 ON (Black) OFF (Red) | 3P 440 V a.c. 15A | M4 | ON (Black) OFF (Red) | Flame retardant ABS resin |
| | 3P 440 V a.c. 30A | M5 | | |
|  Advanced waterproof type BEWT 215 3P 440 V a.c. 15A M4 | | | | |
|  Advanced waterproof type BEWT 315 3P 440 V a.c. 15A M4 FOR. (Black) STOP (Red) REV. (Black) | | | | |

MAIN / CAM SWITCHES

MAS series

Specifications

| Appearance | Suffix code | Rated insulation voltage | Rated conduction current |
|---|-------------|--------------------------|--------------------------|
|  | MAS-025-A/B | 690 V a.c. | 25 A |
| | MAS-063-A/B | | 63 A |
| | MAS-125-A/B | | 125 A |

Suffix code

| Model | Code | Content |
|----------------------|---|---|
| MAS- | <input type="checkbox"/> <input type="checkbox"/> | Main switch |
| Rated current | 025 | For AC25 A |
| | 063 | For AC63 A |
| | 125 | For AC125 A |
| Color classification | A | For emergency stop (yellow guard, red handle) |
| | B | Basic type (white guard, black handle) |

SQ4 series

Specifications

| Model | SQ4 | |
|----------------------------------|---|-----------------------------------|
| Appearance |  | |
| Rated insulation voltage (Ui) | 690 V a.c. | |
| Impulse withstand voltage (Uimp) | 2,500 V a.c. | |
| Rated conduction current (Ith) | 16 A | |
| Rated conduction current (Ie) | 16A-24 V a.c. / 8A-48 V a.c. / 5A-110 V a.c. / 3A-220 V a.c. / 1.8A-380 V a.c. | |
| Rated operating voltage (Ue) | 480 V a.c. | |
| Mechanical life | 300,000 Times | |
| Electrical life | AC: 200,000 Times, DC: 100,000 Times | |
| Ambient temperature & humidity | -25 ~ 55 °C, less than 90% RH (however, there should be no condensation) | |
| Altitude | 2,000 m or less | |
| Material for each part | Body | NY66 GF15 % flame retardant grade |
| | Cam | ACETAL |
| | Contact | AgNi |
| | Terminal | BRASS |
| | Bolt | Iron (galvanized) |
| | Spring | Stainless (STS) |
| | Handle | PC flame retardant grade |





Suffix code

| Model | Code | Content |
|--|--|---|
| SQ4- | <input type="checkbox"/> <input type="checkbox"/> <input type="checkbox"/> - <input type="checkbox"/> <input type="checkbox"/> <input type="checkbox"/> <input type="checkbox"/> | Cam switch |
| install | F | 4-Hole panel mounting |
| Nameplate frame | S | Square nameplate frame (48 X 48 mm) |
| Handle | H | H-type handle (general industrial) |
| | R | R-type handle (voltmeter, ammeter switch) |
| Selected number of stages | 2 | 2nd stage selection |
| | 3 | 3nd stage selection |
| | 4 | 4nd stage selection |
| | 5 | 5nd stage selection |
| | 6 | 6nd stage selection |
| Number of contact units stacked | 7 | 7nd stage selection |
| | 1 | 1 Rows |
| | 2 | 2 Rows |
| | 3 | 3 Rows |
| | 4 | 4 Rows |
| | 5 | 5 Rows |
| 6 | 6 Rows | |
| Standard circuit diagram serial number | 0 1 | 01 ~ 99 |

* For standard products, refer to the individual model code. (Voltmeter, ammeter switch, etc.)

HY-SQ5/255/305/MRK series

Specifications

| Model | | Square type | Round type | Handle locking type | Bottom (C) type | Square key type | |
|----------------|--------------------------|--|---|--|---|---|--|
| Appearance | |  |  |  |  |  | |
| Contact rating | Rated insulation voltage | 600 V | | | | | |
| | Rated current | 10 A, 20 A | | | | | |
| | Contact structure | 2 Cut-off slow-make 1- stage 2 contacts, max. 6 positions (max. 3 positions for the momentary version) | | | | | |
| | Operation method | Each position fixed, spring return type | | | | | |
| | Selection angle | 30°, 45°, 60°, 90° | | | | | |
| | Positions | 2 positions ~ 12 positions, 2 positions ~ 4 positions | | | | | |
| | Insulation resistance | 100 MΩ (500 V d.c.) | | | | | |
| | Life | Dielectric strength | 2,500 V a.c. for 1 min | | | | |
| | | Mechanical | Min. 500 thousand operations | | | | |
| | | Electrical | ● Min. 100 thousand operations, ● MRK : Min. 200 thousand operations | | | | |
| | Ambient temperature | -20 ~ 50 °C | | | | | |
| | Degree of protection | ● 305, 255 (Round type) : IP65 (IEC 60529), ● SQ5 (Square type) : IP40 (IEC 60529) | | | | | |
| Part materials | Body | Heat-resistant Polycarbonate (PC) | | | | | |
| | Cam | Acetal | | | | | |
| | Contacts | Ag + Ni | | | | | |
| | Terminals | Brass | | | | | |
| | Bolt | Swrm | | | | | |
| | Springs | Stainless Steel | | | | | |
| | Handle | Phenol Resin | | | | | |

New product
Control switch

High-end
Control switch

New product
assembly
Indicator light
Rectangular
indicator light

Power switch
Main switch

Cam switch

Limit
switch

Micro
switch

Foot switch
Mono lever
switch

Hoist
switch

Suffix code

| Model | Code | | | | | | Content |
|--|--------------------------|--------------------------|--------------------------|--------------------------|--------------------------|--------------------------|---|
| Appearance | <input type="checkbox"/> | <input type="checkbox"/> | <input type="checkbox"/> | <input type="checkbox"/> | <input type="checkbox"/> | <input type="checkbox"/> | Cam switch |
| | HY-SQ5 | | | | | | Square type cam switch |
| | HY-255 | | | | | | Ø25 type cam switch |
| | HY-305 | | | | | | Ø30type cam switch |
| Contact type | S | | | | | | Square type (standard type) |
| | C | | | | | | Round type (for HY-SQ5) |
| Handle type | H | | | | | | Standard type (standard industrial machine) |
| | R | | | | | | Switch board type (A/S, V/S) |
| | P | | | | | | Control switch type (C/S) |
| Position selection | 2 | | | | | | 2 positions |
| | 3 | | | | | | 3 positions |
| | 4 | | | | | | 4 positions |
| | 5 | | | | | | 5 positions |
| | 6 | | | | | | 6 positions |
| Number of contact unit (Number of rows) | 1 | | | | | | 1 rows |
| | 2 | | | | | | 2 rows |
| | 3 | | | | | | 3 rows |
| | 4 | | | | | | 4 rows |
| | 5 | | | | | | 5 rows |
| | 6 | | | | | | 6 rows |
| Standard circuit diagram serial number | 0 | 1 | | | | | 01 ~ 99 |

※ A/S : ammeter converting switch, V/S: voltmeter converting switch
 ※ Possible to manufacture 20 A, 250 V product only within the square type contact structure

Suffix code

| Model | Code | | | | Content |
|-------------------|------|---|---|---|---|
| HY-MRK | 4 | 2 | 0 | 2 | Key cam switch |
| Contact formation | | | | | Labeled the serial number (refer to the standard circuit diagram) |

LIMIT SWITCHES

HY-M900/LM900 series



| Model | Roller plunger | | Top ball plunger | | Variable roller | | Variable rod wire | | Roller lever | | Coil spring | | Ø50 roller lever | Fork roller Lever | |
|-------------------------------|----------------|---|--|----------|-----------------|----------|-------------------|----------|--------------|----------|-------------|----------|------------------|-------------------|--|
| | HY-M902 | HY-LM902 | HY-M903 | HY-LM903 | HY-M904 | HY-LM904 | HY-M907 | HY-LM907 | HY-M908 | HY-LM908 | HY-M909 | HY-LM909 | HY-M908R | HY-M908L | |
| Appearance | | | | | | | | | | | | | | | |
| Operation speed | | 0.1 - 1 m/s | | | | | | | | | | | | | |
| Opening and closing frequency | Mechanical | | 120 times/minute | | | | | | | | | | | | |
| | Electrical | | 20 times/minute | | | | | | | | | | | | |
| Insulation resistance | | 100 MΩ or more (500 V d.c.) | | | | | | | | | | | | | |
| Dielectric strength | | ● 1000 V a.c. 50/60 Hz for 1 min (between charging part), ● 1500 V a.c. 50/60 Hz for 1 min (between discharging part) | | | | | | | | | | | | | |
| Contact resistance | | Max. 100 MΩ (initial) | | | | | | | | | | | | | |
| Vibration | Malfunction | | 10 - 55 Hz double amplitude width 1.5 mm | | | | | | | | | | | | |
| Shock | Mechanical | | 1,000 m/s or more (100G or more) | | | | | | | | | | | | |
| | Malfunction | | 300m/s or more (30G or more) | | | | | | | | | | | | |
| Life | Mechanical | | More than 1 million times | | | | | | | | | | | | |
| | Electrical | | More than 300,000 times | | | | | | | | | | | | |

● Rating

| Rated voltage(V) | | Non-inductive load (A) | | | | Inductive load (A) | | | |
|------------------|-----|------------------------|----|------|-----|--------------------|----|---------------------|------|
| | | Resistive load | | Lamp | | Inductive load | | Electric motor load | |
| | | NC | NO | NC | NO | NC | NO | NC | NO |
| AC | 125 | 15 | | 3 | 1.5 | 10 | | 3 | 1.5 |
| | 250 | 10 | | 2 | 1 | 6 | | 2 | 1 |
| | 480 | 3 | | 1.5 | 0.8 | 2 | | 1.5 | 0.75 |
| DC | 8 | 15 | | 6 | 3 | 10 | | - | - |
| | 14 | 15 | | 6 | 3 | 10 | | - | - |
| | 30 | 6 | | 4 | 3 | 5 | | - | - |
| | 125 | 0.4 | | 0.2 | 0.2 | 0.05 | | - | - |
| | 250 | 0.2 | | 0.1 | 0.1 | 0.03 | | - | - |

HY-L800 series









| Model | Roller Plunger [horizontal] | Cross roller Plunger type [vertical] | Top Plunger | Roller Adjustable Lever | Rubber Roller Adjustable Lever | Adjustable Rod Lever | Roller Lever | Coil spring |
|--------------------------------|-----------------------------|---|--|-------------------------|--------------------------------|----------------------|--------------|-------------|
| | HY-L802 | HY-L802C | HY-L803 | HY-L804 | HY-L804RE | HY-L807 | HY-L808 | HY-L809 |
| Appearance | | | | | | | | |
| Frequency | Mechanical | | 120 times/minute | | | | | |
| | Electrical | | 30 times/minute | | | | | |
| Insulation resistance | | 100 MΩ 이상 (500 V d.c.) | | | | | | |
| Dielectric strength | | ● Between terminals: 1,500 V a.c. 50/60 Hz 1 minute, ● Between non-charging metal parts: 2,000 V a.c. 50/60 Hz 1 minute | | | | | | |
| Contact resistance | | 25 MΩ or less (initial value), 100 MΩ or less (after test) | | | | | | |
| Vibration | Malfunction | | 10-55 Hz or more, double amplitude 1.5 mm | | | | | |
| Shock | Mechanical | | 300m/s or more (30G or more) | | | | | |
| | Malfunction | | 100m/s or more (10G or more) | | | | | |
| Life | Mechanical | | Over 1 million times (open/close frequency 120 times/min) | | | | | |
| | Electrical | | 100,000 times or more (opening and closing frequency 20 times/min at rated load) | | | | | |
| Ambient temperature & humidity | | -10 ~ 70 °C, 95% RH or less (20 °C) (No condensation) | | | | | | |

● Rating

| Rated voltage | LOAD | Resistive load (cosφ=1) | Inductive load (cosφ=0.4) |
|---------------|------------|-------------------------|---------------------------|
| | 125 V a.c. | | 5 A |
| 250 V a.c. | | 5 A | 2 A |
| 125 V d.c. | | 0.4 A | 0.1 A |











HY-LS800 series

| Model | | Roller Plunger | Push Plunger | Roller Arm | Rubber Roller Lever | Roller Adjustable Lever | Adjustable Rod Lever | Roller Lever | New product Control switch |
|----------------------------------|-------------|---|---|---|---|---|---|---|--|
| | | HY-LS802N | HY-LS803N | HY-LS803RN | HY-LS804RE | HY-LS804N | HY-LS807N | HY-LS808N | |
| Appearance | |  |  |  |  |  |  |  | High-end Control switch |
| Frequency | Mechanical | 120 times/minute | | | | | | | New product assembly Indicator light Rectangular indicator light |
| | Electrical | 30 times/minute | | | | | | | |
| Insulation resistance | | 100 MΩ or more (500 V d.c.) | | | | | | | Power switch Main switch |
| Contact resistance | | 25 MΩ or less (initial value) | | | | | | | |
| Dielectric resistance | | ● 1,000 V a.c. 50/60 Hz for 1 minute, ● 2,000 V a.c. 50/60 Hz 1 minute | | | | | | | Cam switch |
| Vibration | Malfunction | 10-55 Hz double amplitude 1.5 mm | | | | | | | |
| Shock | Mechanical | 1000 m/s ² or more (100 G or more) | | | | | | | Limit switch |
| | Malfunction | 300 m/s ² or more (30 G or more) | | | | | | | |
| Life | Mechanical | More than 1 million times | | | | | | | Micro switch |
| | Electrical | 100,000 times or more | | | | | | | |
| Ambient temperature and humidity | | -10 ~ 70 °C, 95 % RH or less (20 °C) (No condensation) | | | | | | | Foot switch Mono lever switch |

● Ratings

| Rated voltage (V) | | Non-inductive load (A) | | | Inductive load (A) | | | |
|-------------------|-----|------------------------|----|------|--------------------|----|---------------------|----|
| | | Resistive load | | Lamp | Inductive load | | Electric motor load | |
| | | NO | NC | NC | NO | NC | NO | NC |
| AC | 125 | 6 | | 2 | 6 | | 3 | |
| | 250 | 6 | | 1.5 | 6 | | 1.5 | |
| DC | 8 | 6 | | 4 | 6 | | 4 | |
| | 14 | 6 | | 4 | 6 | | 4 | |
| | 30 | 4 | | 2.5 | 4 | | 2.5 | |
| | 125 | 0.4 | | 0.1 | 0.4 | | 0.1 | |
| | 250 | 0.2 | | 0.05 | 0.2 | | 0.05 | |

ZCN-500 series

| Model | | Plunger | Hinge roller short lever | Hinge roller long lever | Hinge short lever | Hinge lever | Hinge long lever | Vertical roller plunger | Horizontal roller plunger | Resin road spring | |
|----------------------------------|-------------|---|---|---|---|---|---|---|---|---|---|
| | | ZCN-P5010 | ZCN-R504A | ZCN-R504C | ZCN-L507A | ZCN-L507C | ZCN-L507D | ZCN-PR508V | ZCN-PR508H | ZCN-L509 | |
| Appearance | |  |  |  |  |  |  |  |  |  |  |
| Operation speed | | 0.1 mm - 0.5 m/s | | | | | | | | | |
| Frequency | Mechanical | 120 times/minute | | | | | | | | | |
| | Electrical | 20 times/minute | | | | | | | | | |
| Insulation resistance | | 100 MΩ or more (500 V d.c.) | | | | | | | | | |
| Contact resistance | | 25 MΩ or less (initial value), 100 MΩ or less | | | | | | | | | |
| Dielectric strength | | ● Between charging part : 1000 V a.c. 50/60 Hz for 1 min, ● between discharging part : 1500 V a.c. 50/60 Hz for 1 min | | | | | | | | | |
| Vibration | Malfunction | 10-55 Hz double amplitude 1.5 mm | | | | | | | | | |
| Shock | Mechanical | 1000 m/s ² or more (100 G or more) | | | | | | | | | |
| | Malfunction | 300 m/s ² or more (30 G or more) | | | | | | | | | |
| Life | Mechanical | More than 1 million times | | | | | | | | | |
| | Electrical | More than 300,000 times | | | | | | | | | |
| Ambient temperature and humidity | | -10 ~ 80 °C 25 ~ 95 % RH (No condensation) | | | | | | | | | |

● Ratings

| Rated voltage(V) | | Non-inductive load(A) | | | Inductive load ((A) | | | |
|------------------|-----|-----------------------|----|----------------|---------------------|---------------------|----|------|
| | | Resistive load | | Inductive load | | Electric motor load | | |
| | | NC | NO | NC | NO | NC | NO | |
| AC | 125 | 15 | | 10 | | 3 | | 1.5 |
| | 250 | 10 | | 6 | | 2 | | 1 |
| | 600 | 3 | | 2 | | 1.5 | | 0.75 |
| DC | 8 | 15 | | 10 | | - | | - |
| | 14 | 15 | | 10 | | - | | - |
| | 30 | 6 | | 5 | | - | | - |
| | 125 | 0.4 | | 0.05 | | - | | - |
| | 250 | 0.2 | | 0.03 | | - | | - |

MICRO SWITCHES

HY-700 series







Specifications

| Model | Panel mounting HY-P701A (Z4G1P05B) | Spring single push button HY-P701B (Z4G1P09B) | Pin push button HY-P701C (Z4G1P01B) | Spring stander push button HY-P701D (Z4G1P03B) | Hinge roller single lever HY-R704A (Z4G1L07B) |
|-------------------------------|--|--|--|---|--|
| Appearance | | | | | |
| Model | Hinge roller middle lever HY-R704B | Hinge roller lever HY-R704C (Z4G1L03B) | 2 positions roller lever HY-R704-2W | Single position lever HY-L707A | Middle lever type HY-L707B |
| Appearance | | | | | |
| Model | Hinge lever HY-L707C (Z4G1L01B) | Special lever HY-L707D | Hinge special lever HY-L707S | Roller panel mounting (Vertical) HY-PR708A | Roller panel mounting (horizontal) HY-PR708B (Z4G1P07B) |
| Appearance | | | | | |
| Operation speed | 0.1 mm - 1 m/s | | | | |
| Allowable operating frequency | Mechanical | 50 - 300 times/minute | | | |
| | Electrical | 20 times/minute | | | |
| Insulation resistance | 100 MΩ or more (500 V d.c.) | | | | |
| Contact resistance | ● Max. 50 MΩ (initial), ● max. 2 Ω (after testing) | | | | |
| Vibration resistance | 10 - 55 Hz double amplitude 0.75mm | | | | |
| Shock resistance | Mechanical | 1,000 m/s or more (100G or more) | | | |
| | Malfunction | 300m/s or more (30G or more) | | | |
| Dielectric strength | 2,000 V a.c. 50/60 Hz 1 minute (each terminal and non-charging metal part) | | | | |
| Life | Mechanical | Over 1 million times (open/close frequency 120 times/min) | | | |
| | Electrical | 300,000 times or more (opening and closing frequency 20 times/min at rated load) | | | |
| Net weight(g) | 31.5 ~ 59.5 g | | | | |
| Rated current (Ie) | 10 A 250 V a.c. (Resistive load) | | | | |

HY-100 series

Specifications

| Model | HY-101 | HY-102N |
|------------------|---|---|
| Appearance |  |  |
| Rated voltage | 250 V a.c., 10 A | 250 V a.c., 10 A |
| Internal switch | SMV-61A-07H | SMV-61A-07H |
| Material of case | Plastic | Aluminum |

| Model | HY-103N | HY-104N | HY-105N |
|------------------|---|--|---|
| Appearance |  |  |  |
| Rated voltage | | 250 V a.c., 10 A | |
| Internal switch | HY-P701B | HY-P701D | HY-P701B |
| Material of case | Aluminum | Aluminum green (Hammer) stamp | |

New product
Control switch

High-end
Control switch

New product
assembly
Indicator light
Rectangular
indicator light

Power switch
Main switch

Cam switch

Limit
switch

Micro
switch

Foot switch
Mono lever
switch



Hoist
switch

Suffix code

| Model | Code | Content |
|------------|--------------------------|----------------------------------|
| HY-10 | <input type="checkbox"/> | Foot Switch |
| Appearance | 1 | Plastic foot switch |
| | 2N | Aluminum foot switch |
| | 3N | Middle size aluminum foot switch |
| | 4 | Large size aluminum foot switch |
| | 5 | Large size aluminum foot switch |

LEL/LES series

Specifications

| Model | LEL (Long lever) | LES (Short lever) |
|--------------------------------|--|---|
| Appearance |  |  |
| Rated insulation voltage | 600 V | |
| Rated current | 3 A 250 V a.c. | |
| Contact structure | 2 Cut-off slow-make 1- stage 2 contacts, max. 4 positions | |
| Insulation resistance | 100 MΩ (500 V d.c.) | |
| Dielectric strength | 2,500 V a.c., for 1 min (between charging part and discharging part) | |
| Contact resistance | 20 MΩ or less (at the time of shipment) | |
| Life | ● Mechanical : Min. 500 thousand operations, ● Electrical : Min. 100 thousand operations | |
| Ambient temperature & humidity | -20 ~ 50 °C, 45 ~ 85 % RH (without condensation) | |

Suffix code

| Model | Code | Content |
|-----------------|--|---------------------|
| LE | <input type="checkbox"/> <input type="checkbox"/> <input type="checkbox"/> | Mono Lever Switch |
| Lever selection | L | Long lever |
| | S | Short lever |
| Stage selection | 01 | 1 st step selection |
| | 02 | 2 st step selection |
| | 03 | 3 st step selection |
| | 04 | 4 st step selection |
| Returning type | 1 | Auto returning |
| | 2 | Manual returning |

※ In the case of the combination return type, it is an order product, so please enter the return operation for each direction. The basic contact configuration for each direction of the product is 1a.

HOIST SWITCHES

HY-P series



NEW

Specifications



| Model | HY-P1022B | HY-P1024BB HY-P1022SB | HY-P1026BBB HY-P1024SBB | HY-P1026SB | HY-P1028BBBB HY-P1028SBBBB | HY-P1029SBBB |
|--------------------------------|---|---|---|---|---|--|
| | 2 button | 4 button/2 button +Push lock turn reset | 6 button/4 button +Push lock turn reset | 6 button/push lock turn reset +1 (switch) | 8 button/push lock turn reset +1 (switch) | 6 button/push lock turn reset + 3 (switch) |
| Degree of protection | IP65 (IEC 60529) | | | | | |
| Materials · Colors | Case | High impact ABS resin | | | | |
| | Contacts | AgSnO2 | | | | |
| Insulation resistance | 100 MΩ (500 V d.c.) | | | | | |
| Dielectric strength | 2,000 V a.c. 1 minute (between charging and non-charging parts) | | | | | |
| Ambient temperature & humidity | -10 ~ 45 °C, 45 ~ 85 % RH (without condensation) | | | | | |

Suffix code





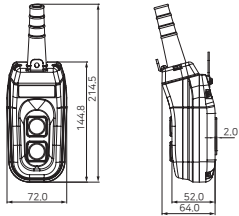

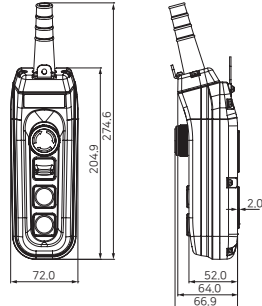



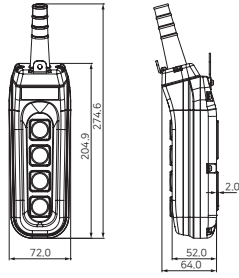

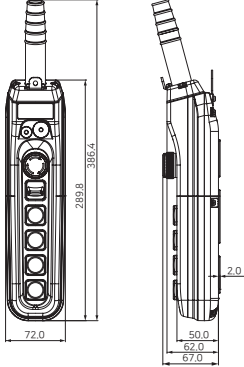
| Model | Code | | | | | | | | Content | | | | |
|----------------------------------|---|--------------------------|--------------------------|--------------------------|--------------------------|--------------------------|--------------------------|--------------------------|--|--|-----------|---------|------------|
| HY- | <input type="checkbox"/> | <input type="checkbox"/> | <input type="checkbox"/> | <input type="checkbox"/> | <input type="checkbox"/> | <input type="checkbox"/> | <input type="checkbox"/> | <input type="checkbox"/> | Hoist switch | | | | |
| Number of buttons | P1022 | X | X | X | X | X | X | X | 2 buttons | | | | |
| | P1024 | X | X | X | X | X | X | X | 4 buttons | | | | |
| | P1026 | X | X | X | X | X | X | X | 6 buttons | | | | |
| | P1028 | X | X | X | X | X | X | X | 8 buttons | | | | |
| | P1029 | X | X | X | X | X | X | X | 9 buttons | | | | |
| Emergency switch | S | | | | | | | | None | | | | |
| | S1 | | | | | | | | 1b Basic specifications 1a1b Contacts on-demand | | | | |
| Contacts and control switches | P | P | P | | | | | | MRP-RA0 | MR control switches * Arrangement order and type may vary according to order specifications. * There are 6 types of nameplates when selecting a control switch. (POWER, MAIN-AUX, OFF ON, HORN, LIGHT, A+B B) * If you do not select it, it will be shipped without a nameplate. | | | |
| | H | H | H | | | | | | MRF-RM1 | | | | |
| | M | M | M | | | | | | MRS-R2A1 | | | | |
| | Y | Y | Y | | | | | | MRS-R3A2 | | | | |
| | K | K | K | | | | | | MRK-R2A1 | | | | |
| | | | | A | A | A | A | | | HY-PA | 1a | Default | |
| | | | | B | B | B | B | | | HY-PB | 1a-1a | | |
| | | | | C | C | C | C | | | HY-PC | 1a-1a | | |
| | | | | D | D | D | D | | | HY-PD | 2a-2a | | |
| | | | | E | E | E | E | | | HY-PE | 2a-2a | | |
| | | | | A1 | A1 | A1 | A1 | | | HY-PA1 | 1a1b | | Order made |
| | | | | B1 | B1 | B1 | B1 | | | HY-PB1 | 1a1b-1a1b | | |
| | | | | C1 | C1 | C1 | C1 | | | HY-PC1 | 1a1b-1a1b | | |
| | | | E1 | E1 | E1 | E1 | | | HY-PE1 | 2a2b-2a2b | | | |
| | | | F | F | F | F | | | HY-PF | 2a | | | |
| | | | F1 | F1 | F1 | F1 | | | HY-PF1 | 2a2b | | | |
| | | | | | | | | | | | | | |
| Other | Toggle switch and volume required by consumers, etc. Separate order available for mounting other options | | | | | | | | Toggle switch (2rd 3rd) | | | | |
| | | | | | | | | | Volume 1K,2K,3K,Etc | | | | |
| | | | | | | | | | Ø 8~16 controller switches | | | | |

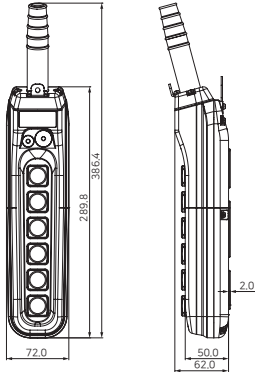
※ Except where X is indicated in the model configuration

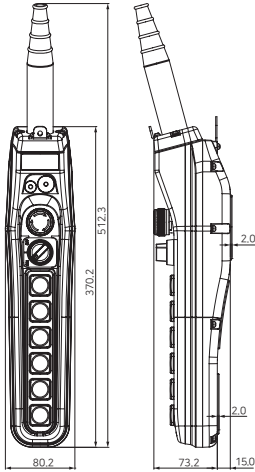
External dimensions

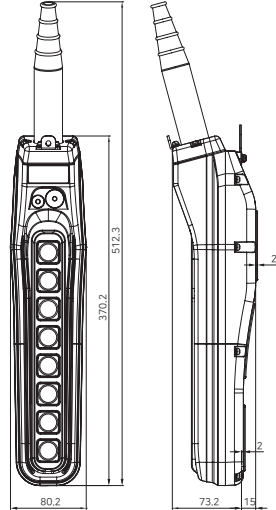
| Model | Appearance | External dimensions | Model | Appearance | External dimensions |
|----------------------|---|---|---|--|---|
| HY-P1022 2 button |  |  | HY-P1022S 2 button +Push lock turn reset |  |  |

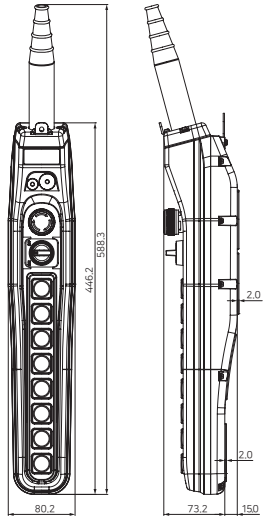

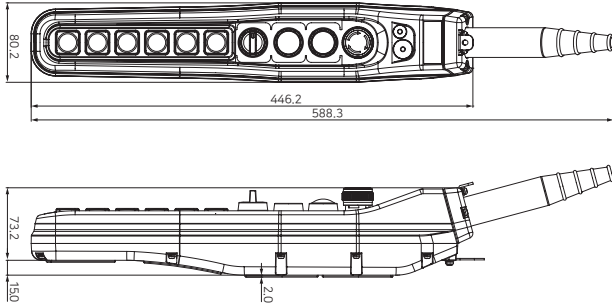



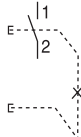
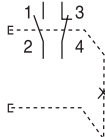
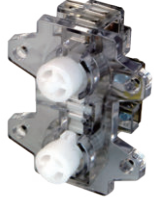
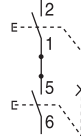
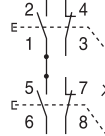

External dimensions

| Model | Appearance | External dimensions | Model | Appearance | External dimensions |
|---|---|--|--|---|---|
| HY-P1024 4 button |  |  | HY-P1024S 4 button +Push lock turn reset |  |  |
| HY-1026 6 button |  |  | HY-1026S 6 button + 1 switch +Push lock turn reset |  |  |
| HY-P1028 8 button |  |  | HY-P1028S 8 button + 1 switch +Push lock turn reset |  |  |
| Model | Appearance | External dimensions | | | |
| HY-P1029S 6 button+ 3 switch +Push lock turn reset |  |  | | | |

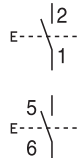
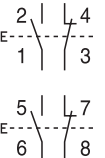

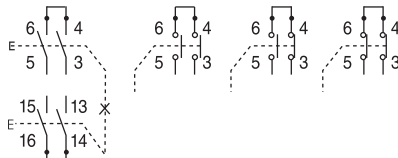
- New product
Control switch
- High-end
Control switch
- New product
assembly
Indicator light
Rectangular
indicator light
- Power switch
Main switch
- Cam switch
- Limit
switch
- Micro
switch
- Foot switch
Mono lever
switch
- Hoist
switch

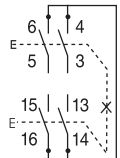
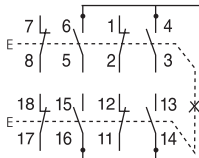
HOIST SWITCHES

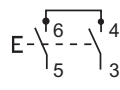
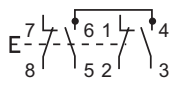
Contact units

| Model | Appearance | Contact configuration | | Information |
|-------|---|---|--|--|
| HY-PA |  | HY-PA(1a)  | HY-PA1(1a1b)  | For on/off operation power, etc. To close and hold, press the top button (ON). To open, press the bottom button (OFF). |
| HY-PB |  | HY-PB(1a-1a)  | HY-PB1(1a1b-1a1b)  | For general circuits (up/down/east/west, etc.) It does not support the simultaneous operation of the 2 buttons with the seesaw-type mechanical interlock. |
| HY-PC |  | HY-PC(1a-1a)  | HY-PC1(1a1b-1a1b)  | For general circuits. It supports the simultaneous operation of the 2 buttons because there is no mechanical interlock. |
| HY-PD |  | HY-PD(2a-2a)  | | For speed control and 2-circuit control The contacts are divided into two stages. It does not support the simultaneous operation of the 2 buttons with the seesaw-type mechanical interlock. |
| HY-PE |  | HY-PE(2a-2a)  | HY-PE1(2a2b-2a2b)  | For general circuits. 2a-2a / 2a2b-2a2b contacts. It does not support the simultaneous operation of the 2 buttons with the seesaw-type mechanical interlock. |
| HY-PF |  | HY-PF(2a)  | HY-PF1(2a2b)  | For general circuits. You can freely assemble and configure it according to the independent 1 contact switch. Up to 2a2b contacts (1a, 1b, 1a1b, 2a1b, 2a2b) |

Contact units (Push lock turn reset switch)



| Model | Appearance | Contact configuration | | Explanation |
|-------|---|--|---|--|
| HY-PS |  | HY-PS  | HY-PS1  | When the button is pressed, the pressed state is maintained. Return turns in the direction of the printed arrow. (Moving part + contact) |

Accessories

| Model | Appearance | Explanation |
|--------------|---|--|
| PS-3R(HOIST) |  | Switch on operation part (excluding contact) |



STS series

Specifications

| Model | STS 040 | STS 060 | STS 080 |
|--------------------------|---|---|---|
| Appearance |  |  |  |
| Circumference size | Ø 40 | Ø 60 | Ø 80 |
| Bracket selection | <ul style="list-style-type: none"> ● Plastic round bracket ● L type bracket ● Elbow bracket (option) | <ul style="list-style-type: none"> ● Plastic round bracket ● L type bracket ● Elbow bracket (option) | <ul style="list-style-type: none"> ● Plastic round bracket ● L type bracket ● Elbow bracket (option) |
| Rated voltage | 24 V a.c. 50/60 Hz or 24 V d.c. (Order specification when the power supply voltage is 12 V) | | |
| Number of stacked layers | 1, 2, 3, 4, 5 stacks | | |
| Color | Red, Yellow, Green, Blue, White | | |
| Power Consumption | Max. approx. 6 W for 5 stacks (0.9 W per each stack) | | |
| Body material | Heat resistant ABS | | |

| |
|-------------------------------|
| Sign Tower |
| Modular Sign Tower |
| New product Panel lamp |
| Wall mounting Indicator light |
| Rotating beacon |
| Warning light |

Suffix code





| Model | Code | Content |
|--------------------------|---|---|
| STS | <input type="checkbox"/> - <input type="checkbox"/> <input type="checkbox"/> <input type="checkbox"/> | Sign Tower With Continuous Light |
| Diameter size | 040 | Ø 40 cylinder type |
| | 060 | Ø 60 cylinder type |
| | 080 | Ø 80 cylinder type |
| Power voltage | C51 | 24 V a.c. 50/60 Hz or 24 V d.c.(dual usage) |
| | D41 | 12 V a.c. 50/60 Hz or 12 V d.c.(dual usage) |
| Number of stacked layers | 1 | 1 stack (red) |
| | 2 | 2 stack (red, green) |
| | 3 | 3 stack (red, yellow, green) |
| | 4 | 4 stack (red, yellow, green, blue) |
| | 5 | 5 stack (red, yellow, green, blue, white) |
| Bracket selection | M |  PIPE connection type plastic base (MP-40, MP-60, MP-80) |
| | L |  L-shaped bracket |
| Optional | |  Plastic elbowbracket (EPM-18, EPM-25) |

※ The power supply voltage is 12 V a.c. 50/60 Hz or 12 V d.c. If it is, the order specification

SIGN TOWERS

STL series

Specifications

| Model | STL 025 | STL 040 | STL 060 | STL 080 |
|--------------------------|---|---|--|---|
| Appearance |  |  |  |  |
| Circumference size | Ø 25 | Ø 40 | Ø 60 | Ø 80 |
| Function | Continuous light only | ● A : Continuous light, ● F : Continuous light, Flashing light, Buzzer | | |
| Rated voltage | 24 V d.c. | 24 V a.c. 50/60 Hz or 24 V d.c., 100-240 V a.c. 50/60 Hz | | |
| Number of stacked layers | 1, 2, 3, 4, 5 stacks | | | |
| Bracket selection | ● L-shaped pedestal (ST-AG: sold separately) | ● Direct installation (bolt fixed installation) ● Plastic round pedestal ● L-shaped bracket, ● STM-84 (option) ● STM-105 (option) ● Elbow type bracket (EPM) (option) | | |
| Color | Red, Yellow, Green, Blue, White | | | |
| Power Consumption | About 4 W or less (Based on 5 stages, 0.6 W for each stage) | Max. approx. 8 W for 5 stacks (1.2 W per each lamp) | | |
| Buzzer size | - | 75 dB (1 m) | 85 dB (1 m) | |

Suffix code (STL025)





| Model | Code | Content |
|---------------|--|---|
| STL | <input type="checkbox"/> - <input type="checkbox"/> <input type="checkbox"/> <input type="checkbox"/> <input type="checkbox"/> | Sign tower (LED light source) |
| Diameter size | 025 | Ø25 cylinder type |
| Power voltage | D51 | 24 V d.c. (LED light source) |
| Module colors | 1 | 1 stack (red) |
| | 2 | 2 stack (red, green) |
| | 3 | 3 stack (red, yellow, green) |
| | 4 | 4 stack (red, yellow, green, blue) |
| | 5 | 5 stack (red, yellow, green, blue, white) |
| polarity | N | NPN (Common Anode) |
| | P | PNP (Common Cathode) |

※ Color of modules can be changed at customer's request

※ L type bracket sold separately



Suffix code (STL040, 060, 080)

| Model | Code | Content |
|-------------------|--|---|
| STL | <input type="checkbox"/> - <input type="checkbox"/> <input type="checkbox"/> <input type="checkbox"/> <input type="checkbox"/> | Sign tower (LED light source) |
| Diameter size | 040 | Ø 40 cylinder type |
| | 060 | Ø 60 cylinder type |
| | 080 | Ø 80 cylinder type |
| Function | A | Continuous light only |
| | F | Continuous light, flashing light and buzzer (selected by the external signal) |
| Power voltage | C51 | 24 V a.c. 50/60 Hz or 24 V d.c. (dual usage) |
| | A11 | 100-240 V a.c. 50/60 Hz |
| Module colors | 1 | 1 stack (red) |
| | 2 | 2 stack (red, green) |
| | 3 | 3 stack (red, yellow, green) |
| | 4 | 4 stack (red, yellow green, blue) |
| | 5 | 5 stack (red, yellow, green, blue, white) |
| Bracket selection | D | Direct installation (bolt fixing installation) |
| | L |  L type bracket (standard) |
| | M |  PIPE Attachable plastic bracket (MP-40, MP-60, MP-80) |
| Optional |  | Optional bracket (STM) |
| |  | Plastic elbow support (EPM-18, EPM-25) |

※ Composition of stacking modules: Upper side (1st stack) to the lower side.





HY-TN series

Specifications

| Stage | Model | Voltage | Consumption power | Bulb | Stage | Model | Voltage | Consumption power | Bulb | Flashing |
|-------|---------------------------|-------------------------|-------------------|------|-------|-------------------------------|-------------------------|-------------------|------|-----------------------|
| 1 | HY-TN-24-1 HY-TN-220-1 | 24 V d.c. 220 V a.c. | 0.21 A 0.04 A | 5 W | 1 | HY-TWBN-24-1 HY-TWBN-220-1 | 24 V d.c. 220 V a.c. | 0.21 A 0.04 A | 5 W | 60 times/ 1 minute |
| 2 | HY-TN-24-2 HY-TN-220-2 | 24 V d.c. 220 V a.c. | 0.42 A 0.08 A | 5 W | 2 | HY-TWBN-24-2 HY-TWBN-220-2 | 24 V d.c. 220 V a.c. | 0.42 A 0.08 A | 5 W | |
| 3 | HY-TN-24-3 HY-TN-220-3 | 24 V d.c. 220 V a.c. | 0.63 A 0.11 A | 5 W | 3 | HY-TWBN-24-3 HY-TWBN-220-3 | 24 V d.c. 220 V a.c. | 0.63 A 0.11 A | 5 W | |
| 4 | HY-TN-24-4 HY-TN-220-4 | 24 V d.c. 220 V a.c. | 0.84 A 0.14 A | 5 W | 4 | HY-TWBN-24-4 HY-TWBN-220-4 | 24 V d.c. 220 V a.c. | 0.84 A 0.14 A | 5 W | |
| 5 | HY-TN-24-5 HY-TN-220-5 | 24 V d.c. 220 V a.c. | 1.05 A 0.17 A | 5 W | 5 | HY-TWBN-24-5 HY-TWBN-220-5 | 24 V d.c. 220 V a.c. | 1.05 A 0.17 A | 5 W | |

| |
|-------------------------------|
| Sign Tower |
| Modular Sign Tower |
| New product Panel lamp |
| Wall mounting Indicator light |
| Rotating beacon |
| Warning light |

Suffix code

| Model | Code | Content |
|---------------------|---|---|
| HY- | <input type="checkbox"/> <input type="checkbox"/> <input type="checkbox"/> <input type="checkbox"/> | HY-TN Series Sign Tower |
| Function | TN | Continuous light only |
| | TWBN: | Continuous light, flashing light, buzzer |
| Power voltage | 24 | 24 V d.c. |
| | 220 | 220 V a.c. |
| Stacking modules | 1 | 1 stack (red) |
| | 2 | 2 stack (red, green) |
| | 3 | 3 stack (red, yellow, green) |
| | 4 | 4 stack (red, yellow, green, blue) |
| | 5 | 5 stack (red, yellow, green, blue, white) |
| Supporter selection |  | No indication (L type bracket standard) |
| Accessories |  | ST-011 (Plastic bracket installation) |
| |  | MP-60 (Plastic bracket installation (Bar type)) |
| |  | EPM (Plastic elbow type bracket) |

PANEL LAMP





STE060 series

Specifications





● Base unit specifications

| Model | STE060-BAD51 | STE060-BFD51 | STE060-BAA11 | STE060-BFA11 | Dimension |
|--------------------------------|--|--|-------------------------|--|---|
| Power voltage | 24 V d.c. | | 100-240 V a.c. 50/60 Hz | |  DC Type AC Type |
| Function | Lighting only | Lighting, Flickering, Buzzer (External signal) | Lighting only | Lighting, Flickering, Buzzer (External signal) | |
| Flickering time | - | 60 times / minute | - | 60 times / minute | |
| Buzzer sound types | - | A single melody / beeping | - | A single melody / beeping | |
| Size of buzzer sound | - | 85 dB (1 m) | - | 85 dB (1 m) | |
| Power Consumption | - | 1.2 W | - | 1.2 W | |
| Ambient temperature & humidity | -5 °C ~ 50 °C, 35 ~ 85 % RH (without condensation) | | | | |
| Weight (g) | 76 g | 96 g | 160 g | 178 g | |

● LED unit specifications

| Model | STE060-LR | STE060-LY | STE060-LG | STE060-LB | STE060-LW |
|--------------------------------|---|---|---|---|---|
| Dimension |  |  |  |  |  |
| Power voltage | 24 V d.c. | | | | |
| Power Consumption | 1.2 W | | | | |
| Light source | LED | | | | |
| Emission angle | 360 ° | | | | |
| Ambient temperature & humidity | -5 °C ~ 50 °C, 35 ~ 85 % RH (without condensation) | | | | |
| Weight (g) | 43 g | | | | |

Suffix code

| Model | Code | Content |
|---------------------|---|--|
| STE060 - | <input type="checkbox"/> <input type="checkbox"/> <input type="checkbox"/> <input type="checkbox"/> | Ø60 LED Light Sign Tower |
| Function | A | Lighting only |
| | F | Lighting, Flickering, Buzzer (External signal) |
| Power voltage | D51 | 24 V d.c. |
| | A11 | 100-240 V a.c. 50/60 Hz |
| Stacking modules | 1 | 1 stack (red) |
| | 2 | 2 stacks (red, Green) |
| | 3 | 3 stacks (red, Yellow, Green) |
| | 4 | 4 stacks (red, Yellow, Green, Blue) |
| | 5 | 5 stacks (red, Yellow, Green, Blue, White) |
| Supporter selection | L |  L type bracket (Standard type) |
| | E |  Elbow type supporter (EPM-18) |
| | M |  Plastic supporter (MP-60) |
| | S |  Plastic supporter (ST-011) |



※ The color was arranged from top to bottom in following order, red, Yellow, Green, Blue, and White. There are two types of functions which are lightening only / Lightening, Flickering & Buzzer.

Base unit suffix code

| Model | Code | Content |
|----------------|--|--|
| STE060 - | <input type="checkbox"/> <input type="checkbox"/> <input type="checkbox"/> | STE060 Sign Tower Base Unit |
| Classification | B | Base unit |
| Function | A | Lighting only |
| | F | Lighting, Flickering, Buzzer (external signal) |
| Power voltage | D51 | 24 V d.c. |
| | A11 | 100-240 V a.c. 50/60 Hz |

LED unit suffix code

| Model | Code | Content |
|----------------|---|----------------------------|
| STE060 - | <input type="checkbox"/> <input type="checkbox"/> | STE060 Sign Tower LED Unit |
| Classification | L | LED unit |
| Unit | R | Red unit |
| | Y | Yellow unit |
| | G | Green unit |
| | B | Blue unit |
| | W | White unit |

STE025 series

Specifications

| | |
|-----------------------|-----------------------------|
| Functions | Continuous light |
| Power voltage | 24 V d.c. |
| Body material / color | ABS / Chrome plated & ivory |
| Lens colors | Red, green, yellow |
| Diameter | Ø 25 |
| Max. number of stacks | 3 Stacks |

Suffix code

| Model | Code | Content |
|------------------|--|-------------------------------|
| STE025 - | <input type="checkbox"/> <input type="checkbox"/> <input type="checkbox"/> | Ø 25 LED Modular Sign Tower |
| Power voltage | D51 | 24 V d.c. |
| Number of stacks | 1 | 1 stack (red) |
| | 2 | 2 stacks (red, green) |
| | 3 | 3 stacks (red, yellow, green) |
| Body color | S | Chrome plated |
| | N | Ivory |



※ L type bracket sold separately





- Sign Tower
- Modular Sign Tower
- New product Panel lamp
- Wall mounting Indicator light
- Rotating beacon
- Warning light

HL series



NEW

Specifications

| Model | HL-100 | HL-200 | HL-300 |
|--------------------------------------|--|--|---|
| Appearance |  |  |  |
| Optical characteristic specification | | | |
| Lens color | Transparency | Transparency | Transparency |
| Lighting color (default) | Daylight | | |
| Color temperature (default) | 6,000 ~ 7,000 K | | |
| Total luminous flux | AC | 509 lm | 1063 lm |
| | DC | - | |
| Illuminance (at 1m) | AC | 205 lux | 368 lux |
| | DC | - | |
| Light efficiency | 102 lm / W | 109 lm/W | 110 lm/W |
| General specification | | | |
| Model | HL-100 | HL-200 | HL-300 |
| LED model used | LG Innotek G3 series (LEMWS59R80FZ) LM80 certification | | |
| Features of the LED chip used | Zener diode is built into the internal circuit of the LED chip. ESD durability is strong through the protection circuit. | | |
| Product life (based on LED) | More than 50,000 hours | | |
| Rated voltage | AC | 110-220 V a.c. | |
| | DC | 12-24 V d.c. | |
| Frequency | 50/60 Hz | | |
| Operating voltage range | 100-240 V a.c. | | |
| Current consumption (A) | 0.023 | 0.046 | 0.046 |
| | - | | |
| Power Consumption | 5 W | 10 W | 10 W |
| | - | | |
| Withstand voltage | AC : 3,000 V a.c., 60 Hz, 1 minute | | |
| Color rendering | 88 | 87 | 88 |
| Responsibility | | | |
| Test Items | Exam conditions | | Result |
| Withstand voltage | AC : 3,000 V a.c., 60 Hz, 1 minute | | Clear |
| Operating temperature | -20 °C ~ +60 °C | | Clear |
| ON/OFF repeated test | Turns off and repeats 1,000 times every 3 seconds | | Clear |
| Aging Test | Operates over 96 hours with rated input | | Clear |
| Acquisition standard |  | | |
| Weight (g) | 10.6 | 13 | 15 |

Suffix code

| Model | Code | Content |
|--------------------|---|----------------------|
| HL | <input type="checkbox"/> <input type="checkbox"/> <input type="checkbox"/> - <input type="checkbox"/> | Universal panel lamp |
| Size and output | 1 0 0 | 5 W |
| | 2 0 0 | 10 W |
| | 3 0 0 | 10 W |
| Input power method | A | 110-220 V a.c. |
| | D | 12-24 V d.c. |

WALL MOUNTED LIGHTS

WME series

Specifications

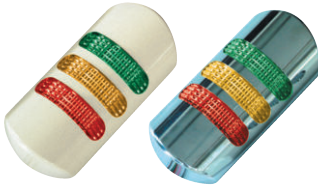
| Model | WME |
|--------------------------|--|
| Appearance |  |
| Function | ● A : Lit indication, ● F : Lit, blinking, buzzer (selected by external signal) |
| Color (body) | ● B : Beige body ● C : Chrome plated body |
| Rated voltage | 24 V a.c. 50/60Hz or 24 V d.c. (Order specification when the power supply voltage is 12 V) |
| Number of stacked layers | 3-stage |
| Power Consumption | 2.1 W or less |
| Buzzer | 2 Types of tones (single/intermittent), approx. 80 dB (1 m) |

Suffix code

| Model | Code | Content |
|---------------|--|--|
| WME- | <input type="checkbox"/> <input type="checkbox"/> <input type="checkbox"/> | Wall Mounted Light |
| Appearance | B | Beige color body |
| | C | Chrome gold plating body |
| Function | A | Continuous light indication |
| | F | Continuous light indication, flashing light indication, buzzer (selected by the external signal) |
| Power voltage | C51 | 24 V a.c. 50/60 Hz or 24 V d.c. |
| | C41 | 12 V a.c. 50/60 Hz or 12 V d.c. C41 ※ order-made |

WMS series

Specifications

| Model | WMS |
|-------------------|---|
| Appearance |  |
| Function | ● A : Continuous light, ● F : Continuous light, Flashing light, Buzzer |
| Lens color | Red, Yellow, Green, Blue, White |
| Rated voltage | 24 V a.c. 50/60 Hz or 24 V d.c. Common (Standard specification) (Order specification when the power supply voltage is 12 V) |
| Number of tiers | 1, 2, 3, 4, 5 tiers |
| Power Consumption | 0.5 W (lamp/1 stage), 3.2 W or less (including 5-stage buzzer) |
| Buzzer | 2 types of tones (single/intermittent), 70 dB (1 m) |

Suffix code

| Model | Code | Content |
|---------------|--|--|
| WMS- | <input type="checkbox"/> <input type="checkbox"/> <input type="checkbox"/> | Wall Mounted Light |
| Appearance | A | Only for continuous light |
| | F | Continuous light, flashing light, buzzer (selected by the external signal) |
| Function | C51 | 24 V a.c. 50/60Hz or 24 V d.c. |
| | | 24 V a.c. / d.c. 50/60 Hz Dual usage (Standard specification) |
| | C41 | 12 V a.c. 50/60 Hz or 12 V d.c. Common ※ "C41" is an order specification |
| Power voltage | 1 | 1 stack (red) |
| | 2 | 2 stack (red, Green) |
| | 3 | 3 stack (red, Yellow, Green) |
| | 4 | 4 stack (red, Yellow, Green, Blue) |
| | 5 | 5 stack (red, Yellow, Green, Blue, White) |

T series

NEW

Specifications

| Model | T060 / T084 | T060 / T084 | T060 / T084 T100 / T150 | T060 / T084 / T100 | T060 / T084 T100 / T150 | T060 / T084 / T100 |
|----------------------|---|-----------------------------------|--------------------------------|-------------------------------|---|-------------------------------|
| Appearance | | | | | | |
| Appearance | Round cap supporter installation | Square cap supporter installation | Square cap direct installation | Round cap direct installation | Square cap direct installation | Round cap direct installation |
| Functions | Rotating continuous light | | | | Rotating continuous light, buzzers | |
| Power voltage | ● 12 V d.c. : 0.08 A, ● 24 V d.c. : 0.06 A, ● 110 - 220 V a.c. : 0.03 A | | | | ● 12 V d.c. : 0.09 A, ● 24 V d.c. : 0.07 A, ● 110 - 220 V a.c. : 0.04 A | |
| Rotating cycle | 180 ± 15% times / 1 minute | | | | | |
| Buzzer volume | - | | | | Approx. 80 dB | |
| Cap materials | Polycarbonate (PC) resin | | | | | |
| Body | ABS resin | | | | | |
| Cap colors | Red, yellow, green, blue | | | | | |
| Degree of protection | IP54 | | | | | |

Sign Tower

Modular Sign Tower

New product Panel lamp

Wall mounting Indicator light

Rotating beacon

Warning light

Suffix code

| Model | Code | Content |
|----------------|-----------------|--|
| T | □ - □ □ □ □ □ □ | Revolving Warning Light |
| Appearance | 060 | Ø 60 |
| | 084 | Ø 84 |
| | 100 | Ø 100 |
| | 150 | Ø 150 |
| Cap appearance | P | Round cap ※ except ø150 model |
| | F | Square cap attachment type |
| Functions | A | Rotating lights |
| | F | Rotating light · Buzzer |
| Power voltage | D12 | 12 V d.c. |
| | D24 | 24 V d.c. |
| | A11 | 110 - 220 V a.c. |
| Cap colors | R | Red |
| | Y | Yellow |
| | G | Green |
| | A | Blue (only with Ø 84 model) |
| Pedestal | D | Direct installation type (basic type) |
| | M | Supporter installation type ※ only with Ø60/ Ø84 models with rotating continuous light |

WARNING LIGHTS

RLA-WX/WXB

Specifications

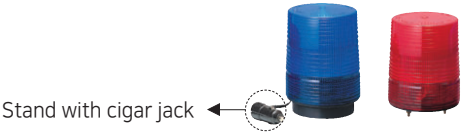

| Model | RLA-WX□□ | RLA-WXB□□ |
|----------------------|---|--|
| Appearance |  <p>Stand with cigar jack ←</p> | |
| Function | Rotating continuous light | Rotating continuous light, buzzer |
| Dimension | Ø118 Square cap (direct installation, magnetic mounting bracket, magnetic mounting bracket and cigar jack) | |
| Power voltage | 12 V d.c., 24 V d.c., 110 V a.c. 50/60 Hz, 220 V a.c. 50/60 Hz | |
| Power consumption | ● 7.2 W (Power voltage : at 24 V d.c.), ● 12 W (Power voltage : at 220 V a.c.) | |
| Flash speed | About 60 times / 1 minute | |
| Light source | Xenon tube strobe light | |
| Buzzer | - | Built-in buzzer (approx. 90 dB 1m apart) |
| Material | ● Cap : Acrylic resin, ● Body : ABS resin | |
| Cap color | Red, blue, white | |
| Protection structure | IP54 (IEC 60529) | |

Suffix code

| Model | Code | Content | |
|---------------|-------|---|---|
| RLA- | □ □ □ | Turn Light (Ø118) | |
| Function | WX | Strobe light | |
| | WXB | Rotating continuous light and buzzer built-in | |
| Power voltage | 01 | 12 V d.c. | |
| | 02 | 24 V d.c. | |
| | 10 | 110 V a.c. | ※ Direct installation type |
| | 20 | 220 V a.c. | |
| | 10M | 110 V a.c. | ※ Permanent magnet stand |
| | 20M | 220 V a.c. | |
| | 01A | 12 V d.c. | ※ Permanent magnet stand with cigar jack for automobile |
| | 02A | 24 V d.c. | |
| Cap color | R | Red | |
| | B | Blue | |

LT series

Specifications

| Appearance | Suffix code | Power voltage | Power consumption | Number of leds | Rotating cycle | Flickering |
|---|-------------|-------------------------------------|---|----------------|------------------------------|------------------------------|
|  | LT-R-12 | 12-48 V d.c., 12-24 V a.c. 50/60 Hz | Max. 2.9 W (power voltage: 12 - 48 V d.c.) | 24 | Approx. 90 times / min | Approx. 50 times / min |
| | LT-R-012 | 110/220 V a.c. 50/60 Hz | Max. 5 W | 24 | | |
|  | LT-P-12 | 12-48 V d.c., 12-24 V a.c. 50/60 Hz | Max. 2.9 W (power voltage: 12 - 48 V d.c.) | 24 | | |
| | LT-P-012 | 110/220 V a.c. 50/60 Hz | Max. 5 W | 24 | | |
| | LT-PB-12 | 12-48 V d.c., 12-24 V a.c. 50/60 Hz | Max. 2.9 W (power voltage: 12 - 48 V d.c.) | 24 | | |
| | LT-PB-012 | 110/220 V a.c. 50/60 Hz | Max. 5 W | 24 | | |

Sign Tower

Modular
Sign TowerNew product
Panel lampWall mounting
Indicator lightRotating
beacon

Warning light

Suffix code

| Model | Code | Content |
|---------------------------------|--|---|
| LT- | <input type="checkbox"/> <input type="checkbox"/> <input type="checkbox"/> | Signal Light (Ø84 Cap) |
| Installation type (Function) | R | Supporter mounting (rotating, flashing) |
| | P | Direct mounting (rotating, flashing) |
| | PB | Direct mounting (rotating, flashing, buzzer built-in) |
| Power voltage | 12 | 12-48 V d.c., 12-24 V a.c. 50/60 Hz |
| | 012 | 110/220 V a.c. 50/60 Hz |
| Cap color | R | Red |
| | Y | Yellow |
| | G | Green |

SLB series

Specifications

| Model | SLB 060 |
|-----------------------|--|
| Appearance |  |
| Dimensions (cap size) | Ø 70 Cap |
| Shape and function | ● P : Direct installation of round cap , ● R : Installation with round cap base, ● F : Direct installation of square cap, ● X : Installation with square cap base |
| Function | ● A : Lighting only ● F : Lit, blinking, buzzer (selected by external input signal) |
| Rated voltage | 24 V a.c. 50/60 Hz or 24 V d.c., 110 - 240 V a.c. 50/60 Hz (Order specification when the power supply voltage is 12 V) |
| Color | Red, Yellow, Green |
| Light | LED (Light-emitting diode) |
| Power consumption | Max. 2 W (24 V a.c. / d.c.), max. 3.5 W (110 - 240 V a.c.) |
| Buzzer | ● 2 types of buzzer melodies (single melody, beeping), ● volume : 80 dB (1 m distance) |





Suffix code

| Model | Code | Content |
|---------------------|---|--|
| SLB | <input type="checkbox"/> - <input type="checkbox"/> <input type="checkbox"/> <input type="checkbox"/> | Turn Light |
| Dimension | 060 | Ø 70 Cap |
| Design and function | RA | Round type cap supporter mounting installation |
| | XA | Rectangular type cap supporter mounting installation |
| | PA | Round type cap direct installation |
| | FA | Rectangular type cap direct installation |
| | PF | Round type cap direct installation |
| Power voltage | C51 | 24 V a.c. 50/60 Hz or 24 V d.c. |
| | C41 | 12 V a.c. 50/60 Hz or 12 V d.c. (※ order-made) |
| | A11 | 110 - 240 V a.c. 50/60 Hz |
| Cap color | R | Red |
| | Y | Yellow |
| | G | Green |

BUZZERS

HY-256/306/606/606N

Specifications



| Model | HY-256 | HY-306 | HY-606 | HY-606N |
|-------------------|---|---|---|---|
| Appearance |  |  |  |  |
| Voltage used | 110 V a.c., 220 V a.c. 12 V d.c., 24 V d.c. | | | |
| Power consumption | Approx. 4 VA : HY-256-1, HY-256-2, HY-306-1, HY-306-2 30 mA Max.: HY-256-12, HY-256-24, HY-306-12, HY-306-24 | | Approx. 8 VA : HY-606-1, HY-606N-1, HY-606-2, HY-606N-2 30 mA Max.: HY-606-12, HY-606N-12, HY-606-24, HY-606N-24 | |
| Power frequency | 50/60 Hz (for 110 V a.c., 220 V a.c.) | | | |
| Volume | 85 dB (1 m) * HY-606-12, HY-606N-12, HY-606-24, HY-606N-24: 80 dB (1 m) | | | |
| External diameter | For Ø25 | For Ø30 | Rectangular panel flush (for Ø66) | Rectangular panel extended (□80) |

Suffix code

| Model | Code | Content |
|----------------------|---|------------------------------------|
| HY- | <input type="checkbox"/> <input type="checkbox"/> | Power Buzzer |
| Dimension | 256 | For Ø 25 |
| | 306 | For Ø 30 |
| | 606 | Rectangular panel flush (for Ø 66) |
| | 606N | Rectangular panel extended (□80) |
| Power supply voltage | 1 | 110 V a.c. 50/60 Hz |
| | 2 | 220 V a.c., 50/60 Hz |
| | 12 | 12 V d.c. |
| | 24 | 24 V d.c. |

HY-606MD/606MA

Specifications



| Model | HY-606MD | HY-606MA |
|----------------------|---|---|
| Dimension |  |  |
| Power supply voltage | 12 / 24 V d.c. | 110 / 240 V a.c. |
| Power consumption | Approx. 2.5 W | |
| Power frequency | - | 50/60 Hz (Common) |
| Volume | 98 dB max (1 m) | |
| External diameter | Ø 66 panel cutout dimensions | |

Suffix code

| Model | Code | Content |
|----------------------|--------------------------|----------------------|
| HY-606 | <input type="checkbox"/> | 4-Tone melody buzzer |
| Power supply voltage | MD | 12 / 24 V d.c. |
| | MA | 110 / 220 V a.c. |

HY-226M/256

Specifications

| Model | HY-226MD/MA | HY-256MD/MA |
|----------------------|---|---|
| Dimension |  |  |
| Power supply voltage | 100-240 V a.c. 50/60 Hz / 12 V d.c., 24 V d.c. | 100-240 V a.c. 50/60 Hz / 12 V d.c., 24 V d.c. |
| Power consumption | 0.6 W / 13.5 W | 0.6 W / 13.5 W |
| Power frequency | 50/60 Hz | 50/60 Hz |
| Volume | 80 dB | 80 dB |
| External diameter | Ø22 / Ø25 | Ø25 |

Suffix code

| Model | Code | Content |
|----------------------|---|---|
| HY- | <input type="checkbox"/> <input type="checkbox"/> | 3-Tones Electronic Buzzer |
| Dimension | 226 | Ø 22 / Ø 25 dual usage (Front side: rectangular type) |
| | 256 | Ø 25 (front side: round type) |
| Power supply voltage | MD | 12-24 V d.c. |
| | MA | 100-240 V a.c. 50/60 Hz |









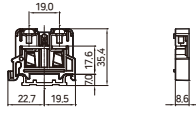

HYBT/HYTM series

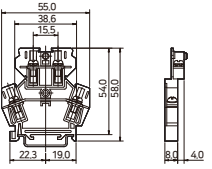
NEW

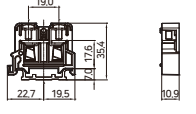

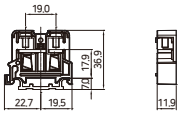

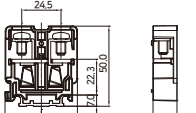

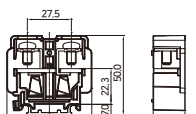

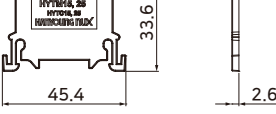

Specifications

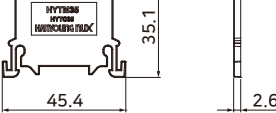
| Classification | Model | | | | | |
|--------------------------------|--|-----------|----------|----------|----------|-----------|
| | HYTM-15A | HYBT-15A2 | HYTM-25A | HYTM-35A | HYTM-60A | HYTM-100A |
| Rated insulating voltage | 600 V | | | | | |
| Rated current | 15A | 15A | 25A | 35A | 60A | 100A |
| Insulation resistance | Min. 100 MΩ (between each live part and between each live part and mounting metal plate) | | | | | |
| Dielectric strength | 2500 V a.c. for 1 min (between live part and unfilled part) | | | | | |
| Terminal bolt | M3.5 | M3.5 | M4 | M4 | M6 | M6 |
| Ambient temperature & humidity | -20 ~ 55 °C, 45 ~ 85 % RH | | | | | |

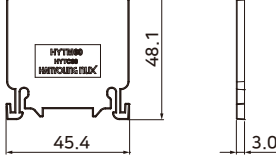
External dimensions

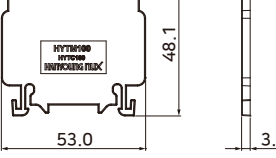
| Model | Appearance | External dimensions |
|-----------|---|---|
| HYTM-15A |  |  |
| HYBT-15A2 |  |  |
| HYTM-25A |  |  |
| HYTM-35A |  |  |
| HYTM-60A |  |  |
| HYTM-100A |  |  |

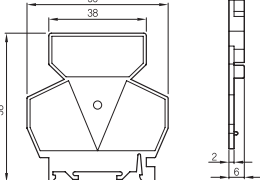
Separator

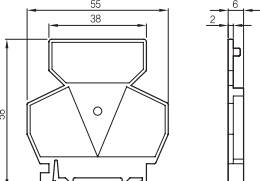
| Model | Appearance | External dimensions |
|-----------------------|--|---|
| HYTM-02 (15A, 25A) |  |  |
| HYTM-04 (35A) |  |  |
| HYTM-05 (60A) |  |  |
| HYTM-06 (100A) |  |  |
| HYBT-12 (HYBT-15A2-A) |  |  |
| HYBT-12 (HYBT-15A2-B) |  |  |

Accessories

Applying Accessory Classification

| Model | HYTM-15A | HYBT-15A2 | HYTM-25A | HYTM-35A | HYTM-60A | HYTM-100A |
|-----------------------------|----------|-----------|----------|----------|----------|-----------|
| Rail | HYBT-01 | | | | | |
| Separator | HYTM-02 | HYBT-12 | HYTM-02 | HYTM-04 | HYTM-05 | HYTM-06 |
| Stopper | HYBT-07 | | | | | |
| Terminal number plate | HYTM-08 | HYBT-08 | HYTM-08 | | | |
| Terminal number plate cover | HYTM-07 | HYBT-10 | HYTM-07 | | | |
| Short terminal | HYBT-13 | HYBT-13 | - | - | - | - |

Strong/
4 tones melody/
3-tone
electronic
buzzer

New product
Prefabricated
Terminal block

New product
Stationary
Terminal block





Fuse holder

Roller steel
Control box

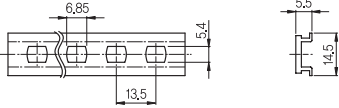

Cable
Connector

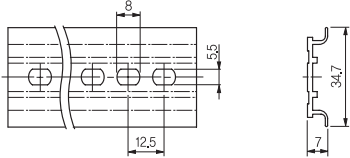
ASSEMBLING TERMINAL BLOCKS

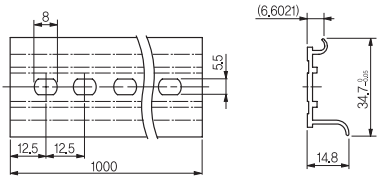

● Aluminum Rail (DIN rail)

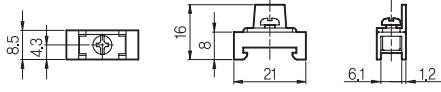
| Appearance | External dimensions |
|---|--|
|  <p>HYBT-CH10 (For 10A)</p> |  |
|  <p>HYBT-01 (For 15A ~ 100A)</p> |  |
|  <p>HYBT-01A (For warp 15 A ~ 100 A)</p> |  |

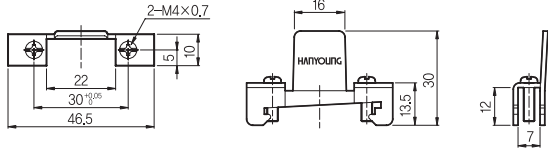

● Stopper

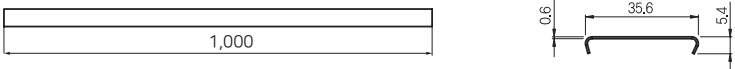
| Model | Appearance | External dimensions |
|-----------|---|--|
| HYBT-ST10 |  |  |
| HYBT-07 |  |  |



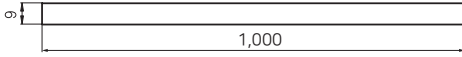

● Terminal number plate cover

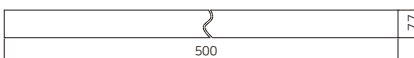
| Model | Appearance | External dimensions |
|----------------------------|---|--|
| HYBT-08 ※ For HYBT-15A2 |  |  |
| HYTM-08 |  |  |

● Seal

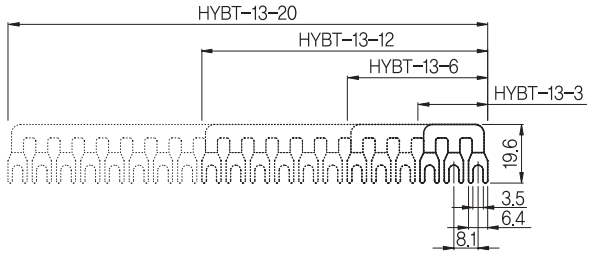
| Model | Appearance | External dimensions |
|---|---|--|
| HYBT-10 (9 mm Width) ※ For HYBT-15A2 |  |  |
| HYTM-07 (7.7 mm Width) |  |  |

● Short Bar

| Appearance | External dimensions |
|---|--|
|  <p>HYBT-13-3</p> |  |
|  <p>HYBT-13-6</p> | |
|  <p>HYBT-13-12</p> | |
|  <p>HYBT-13-20</p> | |

※ Short bar HYBT-13-3~13-20 are only for the HYBT-15A

HYT series

NEW

● For rated current 10 A

| Model | Appearance | Rating | Horizontal | Width | Height | Fixed dimensions |
|----------|---|---------|------------|-------|--------|------------------|
| HYT-1010 |  | 10A 10P | 112 | 24 | 17 | 102.5 |

● For rated current 20 A

| Model | Appearance | Rating | Horizontal | Width | Height | Fixed dimensions |
|----------|---|---------|------------|-------|--------|------------------|
| HYT-203 |  | 20A 3P | 56 | 30 | 20 | 44 |
| HYT-204 | | 20A 4P | 68 | 30 | 20 | 56 |
| HYT-206 | | 20A 6P | 89 | 30 | 20 | 78 |
| HYT-2010 | | 20A 10P | 137 | 30 | 20 | 126 |
| HYT-2012 | | 20A 12P | 163 | 30 | 20 | 150.5 |
| HYT-2015 | | 20A 15P | 199 | 30 | 20 | 187 |
| HYT-2020 | | 20A 20P | 257 | 30 | 20 | 245 |

● For rated current 30 A

| Model | Appearance | Rating | Horizontal | Width | Height | Fixed dimensions |
|----------|---|---------|------------|-------|--------|------------------|
| HYT-303 |  | 30A 3P | 67 | 5 | 24 | 54.5 |
| HYT-304 | | 30A 4P | 83 | 35 | 24 | 70 |
| HYT-306 | | 30A 6P | 113 | 35 | 24 | 100.5 |
| HYT-3010 | | 30A 10P | 153 | 35 | 24 | 143 |

● For rated current 60 A

| Model | Appearance | Rating | Horizontal | Width | Height | Fixed dimensions |
|---------|---|--------|------------|-------|--------|------------------|
| HYT-603 |  | 60A 3P | 84.5 | 40 | 31 | 28 |
| HYT-604 | | 60A 4P | 113.5 | 40 | 31 | 57 |

● For rated current 100 A

| Model | Appearance | Rating | Horizontal | Width | Height | Fixed dimensions |
|----------|---|---------|------------|-------|--------|------------------|
| HYT-1003 |  | 100A 3P | 104.5 | 55.5 | 36.5 | 35 |
| HYT-1004 | | 100A 4P | 140 | 55.5 | 36.5 | 70 |

Strong/
4 tones melody/
3-tone
electronic
buzzer

New product
Prefabricated
Terminal block

New product
Stationary
Terminal block

Fuse holder

Rolled steel
Control box

Cable
Connector

FIXING TYPE TERMINAL BLOCKS

● For rated current 150 A

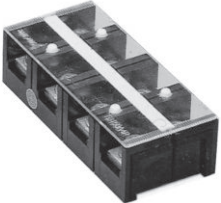
| Model | Appearance | Rating | Horizontal | Width | Height | Fixed dimensions |
|----------|---|---------|------------|-------|--------|------------------|
| HYT-1503 |  | 150A 3P | 115.5 | 67.5 | 41 | 39 |
| HYT-1504 | | 150A 4P | 153 | 67.5 | 41 | 77 |

● For rated current 200 A

| Model | Appearance | Rating | Horizontal | Width | Height | Fixed dimensions |
|----------|---|---------|------------|-------|--------|------------------|
| HYT-2003 |  | 200A 3P | 134 | 72.5 | 44.5 | 45 |
| HYT-2004 | | 200A 4P | 180 | 72.5 | 44.5 | 90 |

● For rated current 300 A

| Model | Appearance | Rating | Horizontal | Width | Height | Fixed dimensions |
|----------|---|---------|------------|-------|--------|------------------|
| HYT-3003 |  | 300A 3P | 155.5 | 83.5 | 49.5 | 51.8 |
| HYT-3004 | | 300A 4P | 207.5 | 83.5 | 49.5 | 103.6 |

● For rated current 400 A





| Model | Appearance | Rating | Horizontal | Width | Height | Fixed dimensions |
|----------|---|---------|------------|-------|--------|------------------|
| HYT-4003 |  | 400A 3P | 155.5 | 83.5 | 49.5 | 51.8 |
| HYT-4004 | | 400A 4P | 207.5 | 83.5 | 49.5 | 103.6 |

● For rated current 500 A

| Model | Appearance | Rating | Horizontal | Width | Height | Fixed dimensions |
|----------|---|---------|------------|-------|--------|------------------|
| HYT-5003 |  | 500A 3P | 204 | 94 | 59.5 | 68 |
| HYT-5004 | | 500A 4P | 270 | 93 | 59.5 | 136 |

HY-F15/F30 series

Specifications

| Model | F15-1A | F15-1D | F15-2A | F15-2D | F15-3A | F15-3D | F30 |
|---------------|---|----------------|---|----------------|--|----------------|---|
| Appearance |  | |  | |  | |  |
| Rated current | 250 V a.c. 15 A | 24 V d.c. 10 A | 250 V a.c. 15 A | 24 V d.c. 10 A | 250 V a.c. 15 A | 24 V d.c. 10 A | 30 A 600 V a.c. |
| Remarks | AC 110-220 V a.c. DC 12-24 V d.c. ※ For Ø 6 X 30 mm ceramic fuses | | | | | | 110-600 V a.c. ※ For Ø 12 X 50 mm ceramic fuses |

Strong/
4 tones melody/
3-tone
electronic
buzzer

New product
Prefabricated
Terminal block

New product
Stationary
Terminal block

Fuse holder

Rolled steel
Control box

Cable
Connector

HY-25/30 series

Specifications

| Appearance | Model | Materials | Remarks |
|--|---------|-------------|---------|
|  | HY-2501 | Rolled iron | Ø 25 |
| | HY-2502 | | |
| | HY-2503 | | |
| | HY-2504 | | |
| | HY-2505 | | |
| | HY-2506 | | |
| | HY-3001 | Rolled iron | Ø 30 |
| | HY-3002 | | |
| | HY-3003 | | |
| | HY-3004 | | |
| | HY-3005 | | |
| | HY-3006 | | |

Suffix code

| Model | Code | Content |
|-------------------|---|---|
| HY- | <input type="checkbox"/> <input type="checkbox"/> | Rolled Iron Control Boxes |
| Installation hole | 25 | Ø 25 installation hole |
| | 30 | Ø 30 installation hole |
| Number of holes | 01 | 1 Hole |
| | 02 | 2 Hole (03 : 3 Hole, 04 : 4 Hole, 05 : 5 Hole, 06 : 6 Hole) |

HYC-M1/M2

Suffix code

| Appearance | Model | Material | Remarks |
|---|--------|--------------------|---------|
|  | HYC-M1 | Polycarbonate (PC) | Ø8 |
| | HYC-M2 | Polycarbonate (PC) | Ø11 |

HANYOUNG nux

MAIN PRODUCTS

Temperature controllers / Recorders / Counters / Timers / Panelmeters / Multi pulse meters / Proximity sensors / Photo sensors / Rotary encoders / Thyristor power regulators / Solid state relays / Power supplies / Control switches / Combination display lights / Power switches / Main switches / Cam switches / Limit switches / Micro switches / Pendant switches / Foot switches / Mono lever switches / Sign towers / Turn lights / Buzzers / Terminal blocks / Fuse holders / Control boxes / Connector cables

HANYOUNG nux

HANYOUNG NUX CO.,LTD.

28, Gilpa-ro 71 beon-gil, Nam-gu, Incheon, Korea
Tel : +82-32-876-4697 Fax : +82-32-876-4696
E-mail : overseas@hynux.com

※ The information contained in this catalogue may change without prior notice for upgrade purposes.